



# Maher Ghaffar & co.

## Surgical Catalogue

2018-2019



# Maher Ghaffar & co.

2018-2019



## Professional Dental Instruments







[www.mgsurgico.com](http://www.mgsurgico.com)



Exhibition Pics





Maher Ghaffar & co













MDS0190694



MDS0190639



MDS0610301



MDS0610302



MDS0610303



MDS0610400



MDS0610402



MDS0610700



MDS0610701



MDS0190629



MDS0610116

### NO. 3K KNIFE HANDLE

Round, knurled.

Item Number	Description
MDS0190694	Overall length 4" (10.2cm)

### NO. 3H KNIFE HANDLES

Hexagonal.

Item Number	Description
MDS0190629	Overall length 4" (10.2cm)
MDS0610765	Collet only for No. 3H knife handle

### NO. 3HL KNIFE HANDLE

Hexagonal.

Item Number	Description
MDS0190639	Overall length 6" (15.2cm)

### NO. 3 KNIFE HANDLE

For blades nos. 10, 11, 12 and 15. Features engraved metric scale.

Item Number	Description
MDS0610301	Overall length 5" (12.7cm)

### NO. 3L KNIFE HANDLE

For blades nos. 10, 11, 12 and 15. Long.

Item Number	Description
MDS0610302	Overall length 8 <sup>3</sup> / <sub>8</sub> " (21.3cm)

### NO. 3LA KNIFE HANDLE

For blades nos. 10, 11, 12 and 15. Long, angled.

Item Number	Description
MDS0610303	Overall length 8" (20.3cm)

### NO. 4 KNIFE HANDLE

For blades nos. 20, 21, 22, 23, 24 and 25.

Item Number	Description
MDS0610400	Overall length 5 <sup>3</sup> / <sub>8</sub> " (13.7cm)

### NO. 4L KNIFE HANDLE

For blades nos. 20, 21, 22, 23, 24 and 25. Long.

Item Number	Description
MDS0610402	Overall length 8 <sup>3</sup> / <sub>8</sub> " (21.3cm)

### NO. 7 KNIFE HANDLE

For blades nos. 10, 11, 12 and 15.

Item Number	Description
MDS0610700	Overall length 6 <sup>3</sup> / <sub>8</sub> " (16.2cm)

### NO. 9 KNIFE HANDLE

Fine. For blades nos. 10, 11, 12 and 15.

Item Number	Description
MDS0610701	Overall length 4 <sup>3</sup> / <sub>4</sub> " (12cm)

### CORWIN KNIFE HANDLE

For blades 10-15C.

Item Number	Description
MDS0610116	Overall length 5 <sup>3</sup> / <sub>4</sub> " (14.6cm)

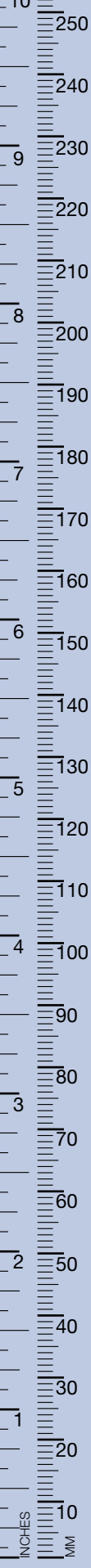

## OPERATING SCISSORS

Sharp/blunt. Tungsten carbide cutting edges.

<b>Item Number</b>	<b>Description</b>
MDS0811414	Straight, 5 $\frac{1}{2}$ " (14.5cm)
MDS0811416	Straight, 6 $\frac{1}{2}$ " (16.5cm)
MDS0811418	Straight, 7 $\frac{1}{4}$ " (18.5cm)
MDS0811514	Curved, 5 $\frac{1}{2}$ " (14.5cm)
MDS0811516	Curved, 6 $\frac{1}{2}$ " (16.5cm)
MDS0811518	Curved, 7 $\frac{1}{4}$ " (18.5cm)

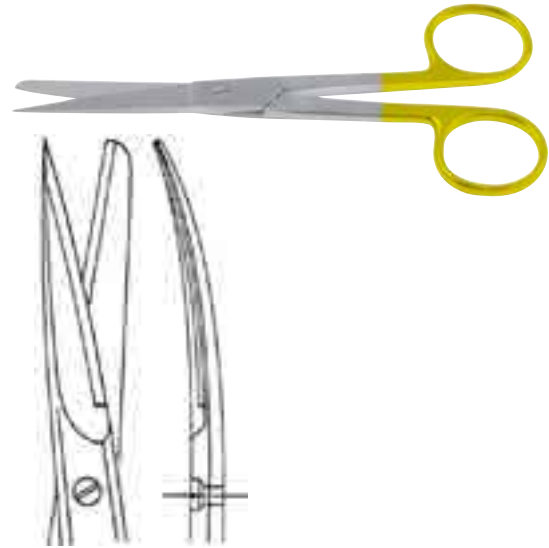

## OPERATING SCISSORS

Sharp/sharp. Tungsten carbide cutting edges.

<b>Item Number</b>	<b>Description</b>
MDS0812414	Straight, 5 $\frac{1}{2}$ " (14.5cm)
MDS0812416	Straight, 6 $\frac{1}{2}$ " (16.5cm)
MDS0812418	Straight, 7 $\frac{1}{4}$ " (18.5cm)
MDS0812514	Curved, 5 $\frac{1}{2}$ " (14.5cm)
MDS0812516	Curved, 6 $\frac{1}{2}$ " (16.5cm)
MDS0812518	Curved, 7 $\frac{1}{4}$ " (18.5cm)

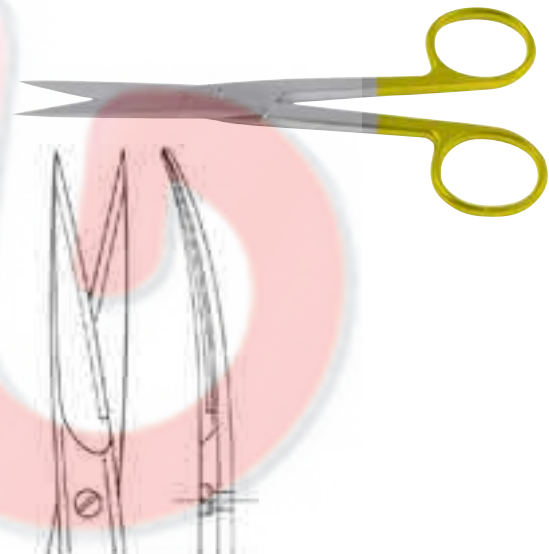

## OPERATING SCISSORS

Blunt/blunt. Tungsten carbide cutting edges.

<b>Item Number</b>	<b>Description</b>
MDS0810414	Straight, 5 $\frac{1}{2}$ " (14.5cm)
MDS0810416	Straight, 6 $\frac{1}{2}$ " (16.5cm)
MDS0810418	Straight, 7 $\frac{1}{4}$ " (18.5cm)
MDS0810514	Curved, 5 $\frac{1}{2}$ " (14.5cm)
MDS0810516	Curved, 6 $\frac{1}{2}$ " (16.5cm)

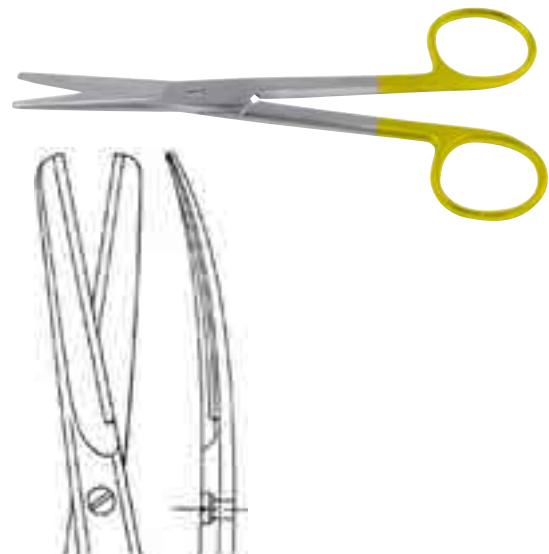



## OPERATING SCISSORS

Straight. Sharp/sharp. Mirror finish.

<u>Item Number</u>	<u>Description</u>
MDS0812010	Overall length 4 $\frac{1}{4}$ " (10.5cm)
MDS0812011	Overall length 4 $\frac{3}{4}$ " (12.1cm)
MDS0812013	Overall length 5" (12.7cm)
MDS0812014	Overall length 5 $\frac{3}{4}$ " (14.6cm)
MDS0812015	Overall length 6" (15.2cm)
MDS0812016	Overall length 6 $\frac{1}{2}$ " (16.5cm)
MDS0812017	Overall length 7" (17.5cm)
MDS0812018	Overall length 7 $\frac{1}{4}$ " (18.5cm)
MDS0812020	Overall length 8" (20cm)



## OPERATING SCISSORS

Straight. Sharp/blunt. Mirror finish.

<u>Item Number</u>	<u>Description</u>
MDS0811011	Overall length 4 $\frac{1}{4}$ " (10.8cm)
MDS0811013	Overall length 5" (12.7cm)
MDS0811014	Overall length 5 $\frac{1}{2}$ " (14cm)
MDS0811015	Overall length 6" (15.5cm)
MDS0811016	Overall length 6 $\frac{1}{2}$ " (18.5cm)
MDS0811017	Overall length 7" (17.5cm)
MDS0811018	Overall length 7 $\frac{1}{4}$ " (18.5cm)
MDS0811020	Overall length 8" (20cm)



## OPERATING SCISSORS

Straight. Blunt/blunt. Mirror finish.

<u>Item Number</u>	<u>Description</u>
MDS0810211	Overall length 4 $\frac{1}{2}$ " (11.5cm)
MDS0810213	Overall length 5" (13cm)
MDS0810214	Overall length 5 $\frac{1}{2}$ " (14.5cm)
MDS0810215	Overall length 6" (15.2cm)
MDS0810216	Overall length 6 $\frac{1}{2}$ " (16.5cm)
MDS0810217	Overall length 7" (17.5cm)
MDS0810218	Overall length 7 $\frac{1}{4}$ " (18.5cm)
MDS0810220	Overall length 8" (20cm)



## OPERATING SCISSORS

Curved-on-flat. Sharp/sharp. Mirror finish.

Item Number	Description
MDS0812110	Overall length 4 <sup>1</sup> / <sub>4</sub> " (10.5cm)
MDS0812111	Overall length 4 <sup>3</sup> / <sub>4</sub> " (12.1cm)
MDS0812113	Overall length 5" (12.7cm)
MDS0812114	Overall length 5 <sup>3</sup> / <sub>4</sub> " (14.6cm)
MDS0812115	Overall length 6" (15.2cm)
MDS0812116	Overall length 6 <sup>1</sup> / <sub>2</sub> " (16.5cm)
MDS0812117	Overall length 6 <sup>5</sup> / <sub>8</sub> " (16.5cm)
MDS0812118	Overall length 7 <sup>1</sup> / <sub>4</sub> " (18.5cm)
MDS0812120	Overall length 8" (20cm)



## OPERATING SCISSORS

Curved-on-flat. Sharp/blunt. Mirror finish.

Item Number	Description
MDS0811111	Overall length 4 <sup>3</sup> / <sub>4</sub> " (12.1cm)
MDS0811113	Overall length 5" (12.7cm)
MDS0811114	Overall length 5 <sup>3</sup> / <sub>4</sub> " (14.6cm)
MDS0811115	Overall length 6" (15.2cm)
MDS0811116	Overall length 6 <sup>1</sup> / <sub>2</sub> " (16.5cm)
MDS0811117	Overall length 7" (17.5cm)
MDS0811120	Overall length 8" (20cm)

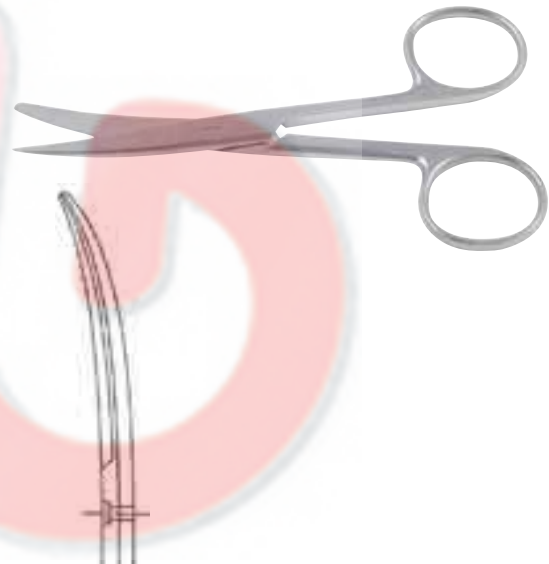

## OPERATING SCISSORS

Curved-on-flat. Blunt/blunt. Mirror finish.

Item Number	Description
MDS0810310	Overall length 4 <sup>1</sup> / <sub>4</sub> " (10.5cm)
MDS0810311	Overall length 4 <sup>3</sup> / <sub>4</sub> " (12.1cm)
MDS0810313	Overall length 5" (12.7cm)
MDS0810314	Overall length 5 <sup>3</sup> / <sub>4</sub> " (14.6cm)
MDS0810315	Overall length 6" (15.2cm)
MDS0810316	Overall length 6 <sup>1</sup> / <sub>2</sub> " (16.5cm)
MDS0810317	Overall length 7" (17.5cm)
MDS0810318	Overall length 7 <sup>1</sup> / <sub>4</sub> " (18.5cm)
MDS0810320	Overall length 8" (20cm)





## METZENBAUM DISSECTING SCISSORS

Blunt/blunt. Tungsten carbide cutting edges.

<b>Item Number</b>	<b>Description</b>
MDS0828415	Straight, overall length 5¾" (14.6cm)
MDS0828418	Straight, overall length 7" (17.8cm)
MDS0828420	Straight, overall length 8" (20cm)
MDS0828423	Straight, overall length 9¼" (23.5cm)
MDS0828425	Straight, overall length 10" (25cm)
MDS0828428	Straight, overall length 11" (28cm)
MDS0828430	Straight, overall length 12" (30cm)
MDS0828515	Curved, overall length 5¾" (14.6cm)
MDS0828518	Curved, overall length 7" (17.8cm)
MDS0828520	Curved, overall length 8" (20cm)
MDS0828523	Curved, overall length 9¼" (23.5cm)
MDS0828525	Curved, overall length 10" (25cm)
MDS0828528	Curved, overall length 11" (28cm)
MDS0828530	Curved, overall length 12" (30.5cm)
MDS0828537	Curved, overall length 14½" (36.8cm)

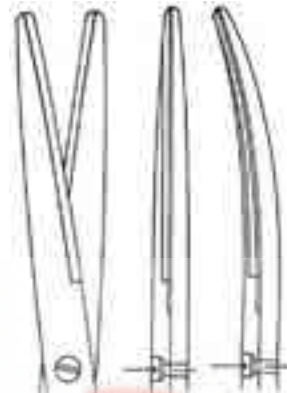

## METZENBAUM DISSECTING SCISSORS

Fine. Blunt/blunt. Tungsten carbide cutting edges.

<b>Item Number</b>	<b>Description</b>
MDS0828615	Straight, overall length 5¾" (14.6cm)
MDS0828618	Straight, overall length 7" (17.8cm)
MDS0828620	Straight, overall length 8" (20cm)
MDS0828623	Straight, overall length 9" (22.9cm)
MDS0828628	Straight, overall length 11" (28cm)
MDS0828715	Curved, overall length 5¾" (14.6cm)
MDS0828718	Curved, overall length 7" (17.8cm)
MDS0828720	Curved, overall length 8" (20cm)
MDS0828723	Curved, overall length 9" (22.9cm)
MDS0828725	Curved, overall length 10" (25cm)

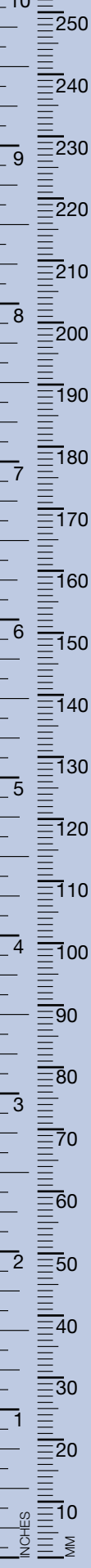
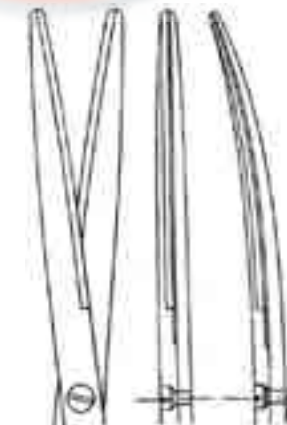
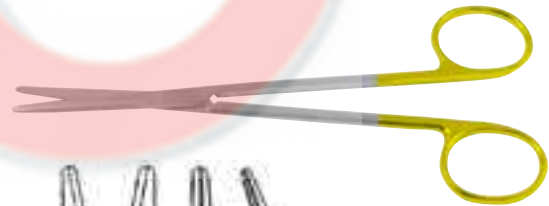

## METZENBAUM DISSECTING SCISSORS

Fine. Sharp/sharp. Tungsten carbide cutting edges.

Item Number	Description
MDS0827615	Straight, overall length 5" (12.7cm)
MDS0827618	Straight, overall length 7" (17.8cm)
MDS0827620	Straight, overall length 8" (20cm)
MDS0827623	Straight, overall length 9 <sup>1</sup> / <sub>4</sub> " (23.5cm)
MDS0827625	Straight, overall length 10" (25cm)
MDS0827628	Straight, overall length 11" (28cm)
MDS0827715	Curved, overall length 5" (12.7cm)
MDS0827718	Curved, overall length 7" (17.8cm)
MDS0827720	Curved, overall length 8" (20cm)
MDS0827723	Curved, overall length 9" (22.9cm)
MDS0827725	Curved, overall length 10" (25cm)
MDS0827728	Curved, overall length 11" (28cm)

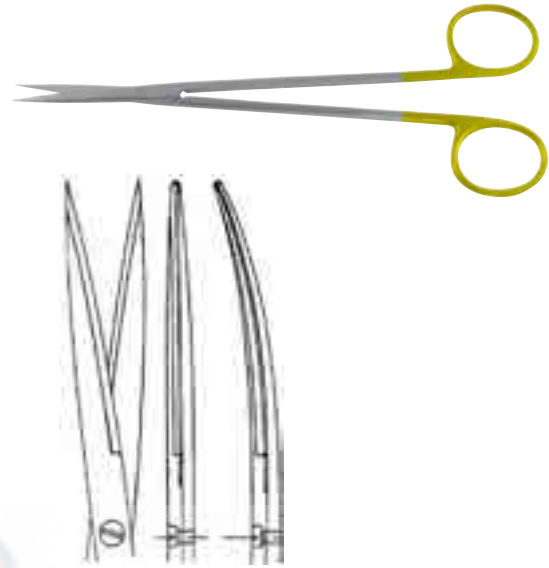

## NELSON DISSECTING SCISSORS

Curved. Blunt/blunt. Tungsten carbide cutting edges.  
Overall length 11" (27.9cm).

Item Number	Description
MDS0828728	Fine
MDG0828528	Regular

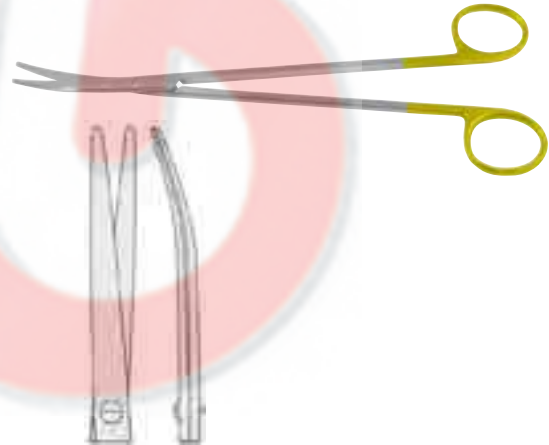

## MAYO DISSECTING SCISSORS

Beveled blades. Tungsten carbide cutting edges.

Item Number	Description
MDS0816414	Straight, overall length 5 <sup>1</sup> / <sub>2</sub> " (14cm)
MDS0816417	Straight, overall length 6 <sup>3</sup> / <sub>4</sub> " (17.1cm)
MDS0816423	Straight, overall length 9" (22.9cm)
MDS0816435	Straight, overall length 14" (35.6cm)
MDS0816514	Curved, overall length 5 <sup>1</sup> / <sub>2</sub> " (14cm)
MDS0816517	Curved, overall length 6 <sup>3</sup> / <sub>4</sub> " (17.1cm)
MDS0816523	Curved, overall length 9" (22.9cm)
MDS0816535	Curved, overall length 14" (35.6cm)

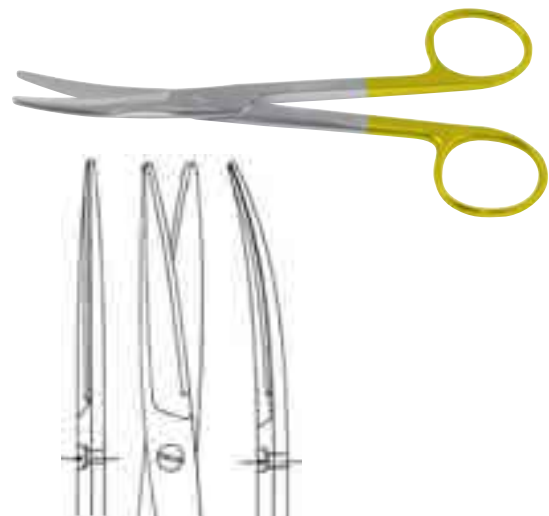

## MAYO DISSECTING SCISSORS

Round blades. Tungsten carbide cutting edges.

Item Number	Description
MDS0817514	Straight, overall length 5½" (14cm)
MDS0817617	Straight, overall length 6¾" (17.1cm)
MDS0817714	Curved, overall length 5½" (14cm)
MDS0817717	Curved, overall length 6¾" (17.1cm)



## KNAPP IRIS SCISSORS

Sharp/sharp. Tungsten carbide cutting edges.  
Overall length 4½" (11.4cm).

Item Number	Description
MDS0834511	Curved
MDS0834411	Straight

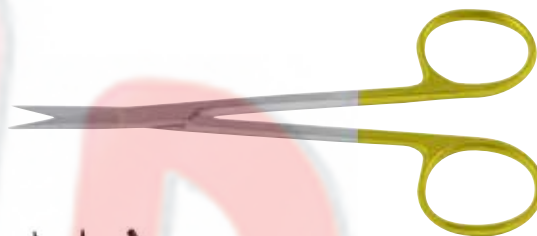

## SUTURE WIRE-CUTTING SCISSORS

Tungsten carbide cutting edges.  
Overall length 5" (12.7cm).

Item Number	Description
MDS0883512	Angled jaws

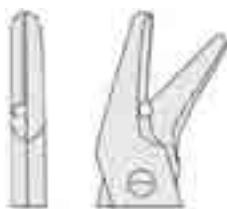



## COTTLE DORSAL ANGULAR SCISSORS

Angled 30°. Blade length 45mm. Tungsten carbide cutting edges.

<b>Item Number</b>	<b>Description</b>
MDS0605011	Overall length 6½" (16.5cm)



## LISTER BANDAGE SCISSORS

Angled, probe point. Tungsten carbide cutting edges.

<b>Item Number</b>	<b>Description</b>
MDS0890518	Overall length 5½" (14cm)



## DEAVER OPERATING SCISSORS

Sharp/blunt. Mirror finish. Overall length 5½" (14cm).

<b>Item Number</b>	<b>Description</b>
MDS0814014	Straight
MDS0814114	Curved

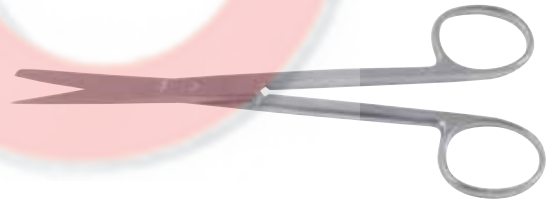

## MAYO-NOBLE DISSECTING SCISSORS

Heavy.

<u>Item Number</u>	<u>Description</u>
MDS0818017	Straight, overall length 6 <sup>3</sup> / <sub>4</sub> " (17.1cm)
MDS0818117	Curved-on-flat, overall length 6 <sup>1</sup> / <sub>2</sub> " (16.5cm)



## MAYO-HARRINGTON DISSECTING SCISSORS

<u>Item Number</u>	<u>Description</u>
MDS0816023	Straight, overall length 9" (22.9cm)
MDS0816028	Straight, overall length 11" (27.9cm)
MDS0816123	Curved, overall length 9" (22.9cm)
MDS0816128	Curved, overall length 11" (27.9cm)

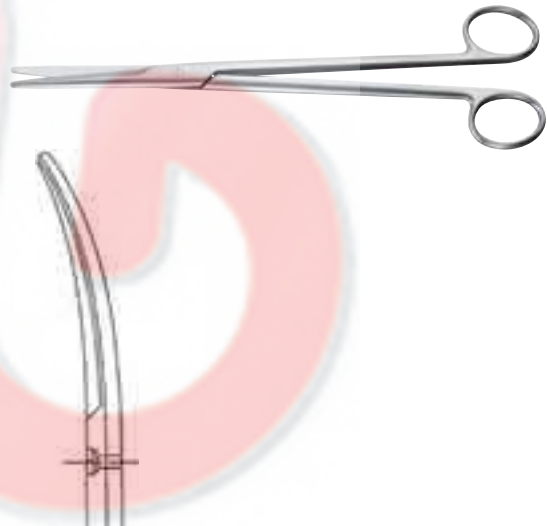

## MAYO-SIMS DISSECTING SCISSORS

Blunt/blunt. Overall length 7<sup>3</sup>/<sub>4</sub>" (19.7cm).

<u>Item Number</u>	<u>Description</u>
MDS0816019	Straight
MDS0816119	Curved-on-flat



## MAYO DISSECTING SCISSORS

Mirror finish.

Item Number	Description
MDS0816014	Straight, overall length 5 <sup>3</sup> / <sub>4</sub> " (14.6cm)
MDS0816017	Straight, overall length 6 <sup>3</sup> / <sub>4</sub> " (17.1cm)
MDS0816021	Straight, overall length 8 <sup>1</sup> / <sub>4</sub> " (21cm)
MDS0816121	Curved, overall length 8 <sup>1</sup> / <sub>4</sub> " (21cm)
MDS0816115	Curved-on-flat, overall length 5 <sup>3</sup> / <sub>4</sub> " (14.6cm)
MDS0816117	Curved-on-flat, overall length 6 <sup>3</sup> / <sub>4</sub> " (17.1cm)
MDS0817119	Curved, Mayo-Stillie, overall length 7 <sup>3</sup> / <sub>4</sub> " (19.7cm)
MDS0817121	Curved, Mayo-Stillie, overall length 8 <sup>1</sup> / <sub>4</sub> " (21cm)

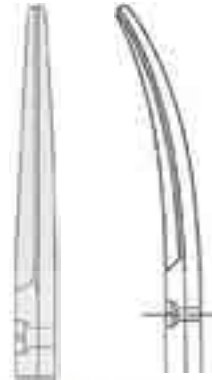

## SUPER CUT MAYO-HARRINGTON SCISSORS

Curved. One serrated blade.

Item Number	Description
MDS0816128S	Overall length 12" (30.5cm)

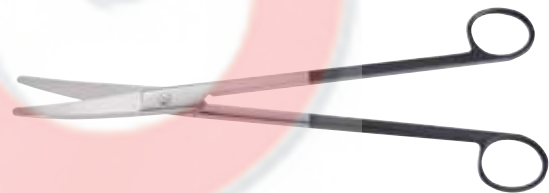

## MAYO DISSECTING SCISSORS

Round blade.

Item Number	Description
MDS0817015	Straight, overall length 5 <sup>3</sup> / <sub>4</sub> " (14.6cm)
MDS0817017	Straight, overall length 6 <sup>3</sup> / <sub>4</sub> " (17.1cm)
MDS0817019	Straight, overall length 7 <sup>3</sup> / <sub>4</sub> " (19.7cm)
MDS0817021	Straight, overall length 8 <sup>1</sup> / <sub>4</sub> " (21cm)
MDS0817115	Curved-on-flat, overall length 5 <sup>3</sup> / <sub>4</sub> " (14.6cm)
MDS0817117	Curved-on-flat, overall length 6 <sup>3</sup> / <sub>4</sub> " (17.1cm)



## METZENBAUM DISSECTING SCISSORS

Overall length 5<sup>3</sup>/<sub>4</sub>" (14.6cm).

Item Number	Description
-------------	-------------

MDS0828015	Straight
------------	----------

MDS0828115	Curved
------------	--------



## METZENBAUM DISSECTING SCISSORS

Dissecting blades. Blunt/blunt. Overall length 7" (17.8cm).

Item Number	Description
-------------	-------------

MDS0828018	Straight
------------	----------

MDS0828118	Slightly curved-on-flat
------------	-------------------------

MDS0828118LH	Slightly curved-on-flat, left-handed
--------------	--------------------------------------

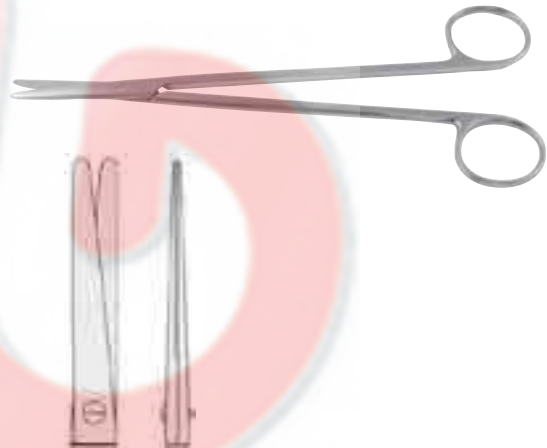

## FINE SCISSORS

Sharp/sharp. Blade 25mm.

Overall length 4<sup>1</sup>/<sub>2</sub>" (11.4cm).

Item Number	Description
-------------	-------------

MDS0859411	Straight
------------	----------

MDS0834312	Curved
------------	--------





## METZENBAUM-LIPSETT SCISSORS

Curved. Serrated edges. Metzenbaum blades thinned down  $\frac{7}{8}$ " (2.2cm) from tips.

Item Number	Description
MDS0225861	Overall length $5\frac{1}{2}$ " (14cm)



## METZENBAUM DISSECTING SCISSORS

Light model. Fine, narrow blades are curved for delicate dissections.

Item Number	Description
MDS0828319	Overall length $7\frac{3}{8}$ " (18.7cm)

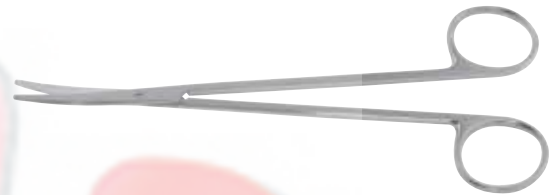

## METZENBAUM DISSECTING SCISSORS

Curved. Blunt/blunt.

Item Number	Description
MDS0828120	Overall length 8" (20cm)
MDS0828123	Overall length 9" (23cm)
MDS0828125	Overall length 10" (25cm)
MDS0828128	Overall length 11" (28cm)

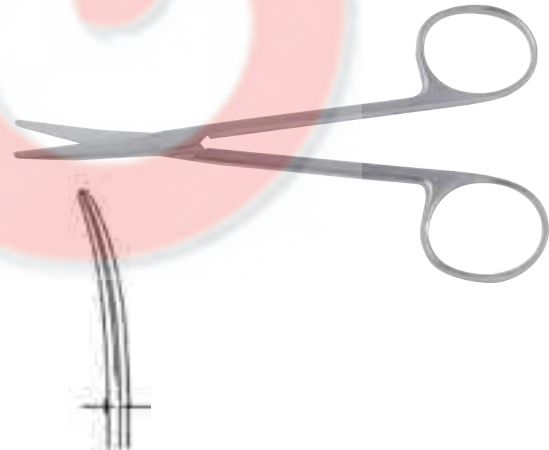

## JORGENSON SCISSORS

A modification of the Mayo dissecting scissors with an exaggerated curve. Mirror finish.

Item Number	Description
MDS0865022	Overall length $8\frac{1}{2}$ " (21.6cm)



## JONES DISSECTING SCISSORS

Curved blades, fine.

<u>Item Number</u>	<u>Description</u>
MDS0123556	Overall length 5½" (14cm)



## THOREK-FELDMAN GALL BLADDER SCISSORS

Curved-on-flat.

<u>Item Number</u>	<u>Description</u>
MDS0864319	Overall length 7¼" (18.4cm)
MDS0864321	Overall length 8½" (21.6cm)



## ROCHESTER-FERGUSON SCISSORS

Angled-on-flat. Mirror finish.

<u>Item Number</u>	<u>Description</u>
MDS0801914	Overall length 5½" (14cm)
MDS0801918	Overall length 7" (17.8cm)

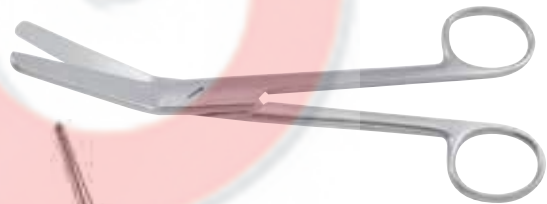

## METZENBAUM DISSECTING SCISSORS

Fine. Curved-on-flat. Mirror finish.

<u>Item Number</u>	<u>Description</u>
MDS0828318	Overall length 7" (17.8cm)

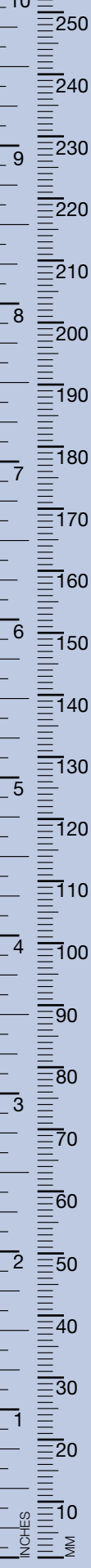



## SUPER CUT METZENBAUM DISSECTING SCISSORS

Curved. Black handles. Overall length 7" (17.8cm).

<b>Item Number</b>	<b>Description</b>
MDS0728118	Dissecting blades slightly curved-on-flat
MDS0728318	Fine



## SUPER CUT METZENBAUM DISSECTING SCISSORS

Curved. Mirror finish. Black handles.

<b>Item Number</b>	<b>Description</b>
MDS0728123	Overall length 9" (22.9cm)

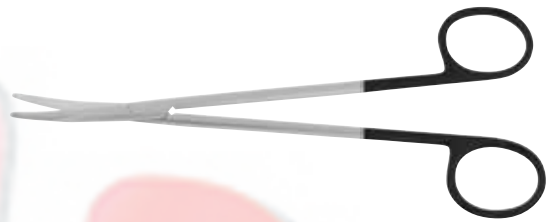

## LINCOLN DISSECTING SCISSORS

Blade length 30mm.

<b>Item Number</b>	<b>Description</b>
MDS0800217	Straight, overall length 7" (17.8cm)
MDS0800117	Curved, overall length 7" (17.8cm)
MDS0800128	Curved, overall length 11" (27.9cm)

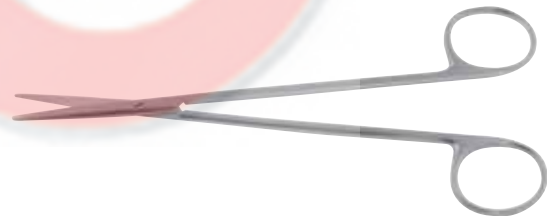

## SPENCER STITCH SCISSORS

<b>Item Number</b>	<b>Description</b>
MDS0880209	Overall length 3 $\frac{1}{2}$ " (8.9cm)
MDS0880211	Overall length 4 $\frac{1}{4}$ " (10.5cm)
MDS0880212	Overall length 4 $\frac{3}{4}$ " (12.5cm)



## SUTURE SCISSORS

Blades curved on the side. Outer blade notched for pick up and cutting of sutures.

<u>Item Number</u>	<u>Description</u>
MDS0880313	Northbent, overall length 5" (12.7cm)
MDS0880309	Shortbent, overall length 3½" (8.9cm)



## WIRE-CUTTING SCISSORS

Overall length 4¾" (12.1cm).

<u>Item Number</u>	<u>Description</u>
MDS0883112	Blades angled-to-side
MDS0885012	Straight blades
MDS0885112	Curved blades

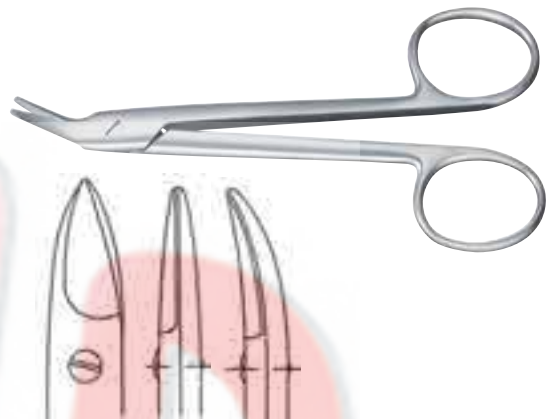

## NEW'S SUTURE SCISSORS

Angled blades. Blunt/blunt.

<u>Item Number</u>	<u>Description</u>
MDS0895088	Overall length 5½" (14cm)



## LITTAUER STITCH SCISSORS

Light model. Straight.

<u>Item Number</u>	<u>Description</u>
MDS0880414	Overall length 5½" (14cm)



## SUTURE SCISSORS

Straight. Sharp/blunt. Mirror finish.

<u>Item Number</u>	<u>Description</u>
MDS0801214	Overall length 5 <sup>3</sup> / <sub>4</sub> " (14.5cm)



## HERCULES PLASTER SHEARS

<u>Item Number</u>	<u>Description</u>
MDS0892119	Overall length 7 <sup>1</sup> / <sub>2</sub> " (19.1cm)

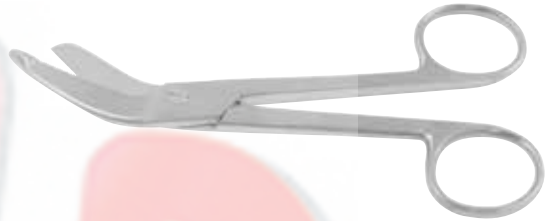

## LISTER BANDAGE SCISSORS

Angled, probe point.

<u>Item Number</u>	<u>Description</u>
MDS0890109	Overall length 3 <sup>1</sup> / <sub>2</sub> " (8.9cm)
MDS0890111	Overall length 4 <sup>1</sup> / <sub>2</sub> " (11.4cm)
MDS0890114	Overall length 5 <sup>1</sup> / <sub>2</sub> " (14cm)
MDS0890115	Overall length 6" (15.5cm)
MDS0890118	Overall length 7 <sup>1</sup> / <sub>4</sub> " (18.4cm)
MDS0890120	Overall length 8" (20.3cm)

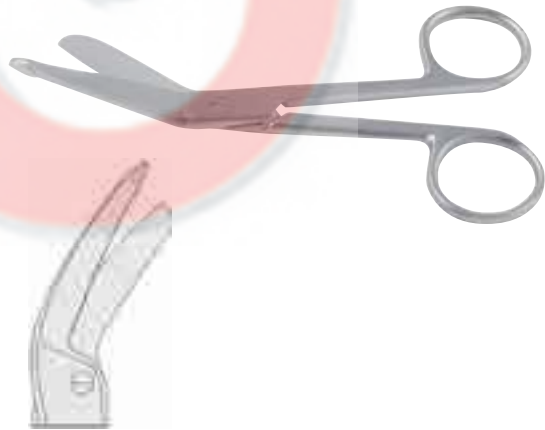

## KNOWLES BANDAGE SCISSORS

Straight, probe point. Mirror finish.

<u>Item Number</u>	<u>Description</u>
MDS0893014	Overall length 5 <sup>1</sup> / <sub>2</sub> " (14cm)





## UNIVERSAL BANDAGE SCISSORS

Heavy-duty. Autoclavable. Black plastic handles.

Item Number	Description
MDS0895014	Overall length 5½" (14cm)
MDS0895016	Overall length 6¼" (16cm)
MDS0895018	Overall length 7" (18cm)



## SUPER CUT LISTER BANDAGE SCISSORS

Black handles.

Item Number	Description
MDS0890114S	Overall length 5¾" (14.6cm)
MDS0890118S	Overall length 7¼" (18.4cm)
MDS0890120S	Large finger ring, overall length 8" (20.3cm)



## HEGAR NEEDLE HOLDERS

Narrow jaws.

Item Number	Description
MDS2419016	Overall length 6¼" (15.9cm)
MDS2419018	Overall length 7¼" (18.4cm)
MDS2419020	Overall length 8" (20.3cm)

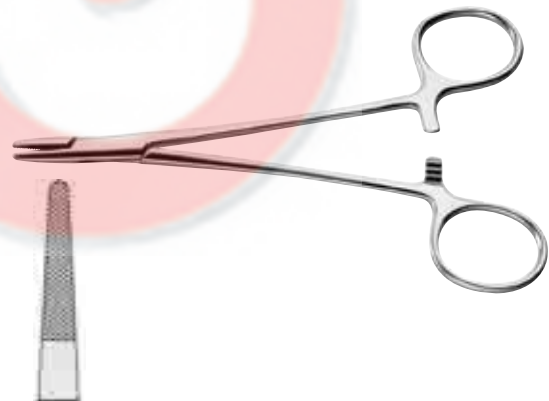

## HEGAR-BAUMGARTNER NEEDLE HOLDER

Serrated jaws.

Item Number	Description
MDS2415014	Overall length 5½" (14cm)



## COLLIER NEEDLE HOLDER

Serrated, fenestrated jaws.

<u>Item Number</u>	<u>Description</u>
MDS2412212	Overall length 5" (12.7cm)



## HEGAR NEEDLE HOLDERS

Stubby jaws.

<u>Item Number</u>	<u>Description</u>
MDS2418015	Overall length 6 <sup>1</sup> / <sub>4</sub> " (15.9cm)
MDS2418018	Overall length 7" (17.8cm)
MDS2418020	Overall length 8" (20.3cm)



## SAROT NEEDLE HOLDERS

Indented shanks. Straight jaws.

<u>Item Number</u>	<u>Description</u>
MDS2432018	Overall length 7 <sup>1</sup> / <sub>8</sub> " (18.1cm)
MDS2432026	Overall length 10 <sup>1</sup> / <sub>4</sub> " (26cm)

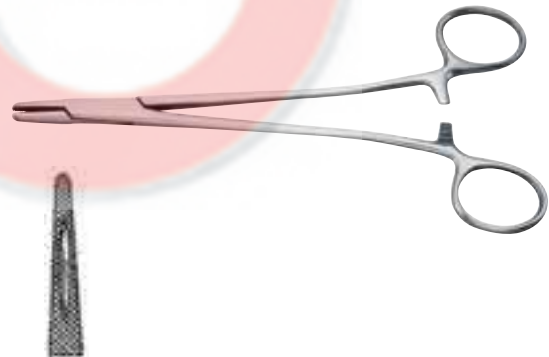

## MASSON NEEDLE HOLDER

<u>Item Number</u>	<u>Description</u>
MDS2425027	Overall length 10 <sup>1</sup> / <sub>2</sub> " (26.7cm)





## CRILE-MURRAY NEEDLE HOLDER

Straight, cross-serrated jaws.

<u>Item Number</u>	<u>Description</u>
MDS2417418	Overall length 7 <sup>1</sup> / <sub>4</sub> " (18.4cm)



## STRATTE NEEDLE HOLDER

Double bend. Curved jaws.

<u>Item Number</u>	<u>Description</u>
MDS2433023	Overall length 9" (22.9cm)



## HEANEY NEEDLE HOLDER

Curved.

<u>Item Number</u>	<u>Description</u>
MDS2424121	Overall length 8 <sup>1</sup> / <sub>4</sub> " (21cm)

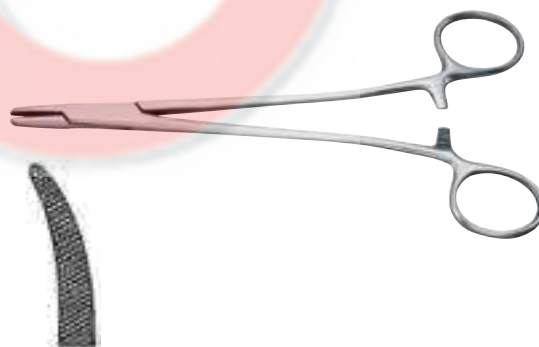

## WANGENSTEEN NEEDLE HOLDER

<u>Item Number</u>	<u>Description</u>
MDS2426027	Overall length 10 <sup>1</sup> / <sub>4</sub> " (26cm)



## MAYO-HEGAR NEEDLE HOLDER

Extra-long. Heavy.

<u>Item Number</u>	<u>Description</u>
MDS2418030	Overall length 14" (35.6cm)



## HALSEY NEEDLE HOLDERS

Overall length 5" (12.7cm). Tungsten carbide inserts.

<u>Item Number</u>	<u>Description</u>
MDS2413413	Smooth jaws
MDS2414413	3,600 serrations per square inch



## NEIVERT NEEDLE HOLDER

One offset ring. Tungsten carbide inserts.  
3,600 teeth per square inch.

<u>Item Number</u>	<u>Description</u>
MDS2414813	Overall length 5" (12.7cm)

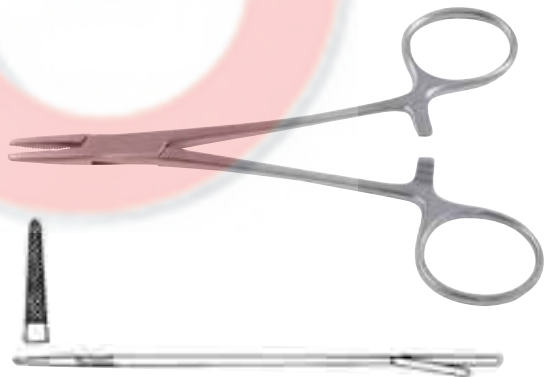

## OLSEN-HEGAR NEEDLE HOLDERS

Cutting edge. Tungsten carbide inserts.  
2,500 teeth per square inch.

<u>Item Number</u>	<u>Description</u>
MDS2441414	Overall length 5 <sup>3</sup> / <sub>4</sub> " (14.6cm)
MDS2441417	Overall length 6 <sup>3</sup> / <sub>4</sub> " (17cm)
MDS2441419	Overall length 7 <sup>1</sup> / <sub>4</sub> " (18.4cm)

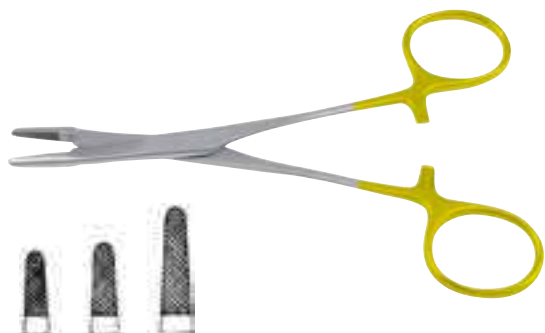

## WEBSTER NEEDLE HOLDERS

Tungsten carbide inserts. Overall length  $4\frac{3}{4}$ " (12.1cm).

Item Number	Description
MDS2410413	Smooth jaws
MDS2410513	3,600 teeth per square inch



## CRILE-WOOD NEEDLE HOLDERS

Tungsten carbide inserts.

Item Number	Description
MDS2416615	Straight, smooth jaws, overall length 6" (15.2cm)
MDS2416415	Straight, serrated inserts, 3,600 teeth per square inch, overall length 6" (15.2cm)
MDS2416418	Straight, serrated inserts, 3,600 teeth per square inch, overall length $7\frac{1}{8}$ " (18.1cm)
MDS2416318	Curved, serrated inserts, 3,600 teeth per square inch, overall length $7\frac{1}{8}$ " (18.1cm)
MDS2416420	Straight, serrated inserts, 3,600 teeth per square inch, overall length 8" (20.3cm)
MDS2416423	Straight, serrated inserts, 3,600 teeth per square inch, overall length 9" (22.9cm)
MDS2416323	Curved, serrated inserts, 3,600 teeth per square inch, overall length $9\frac{1}{4}$ " (23.5cm)
MDS2416326	Straight, serrated inserts, 3,600 teeth per square inch, overall length $10\frac{3}{8}$ " (26.3cm)
MDS2416430	Straight, serrated inserts, 3,600 teeth per square inch, overall length $11\frac{3}{4}$ " (29.8cm)
MDS2416435	Straight, 3,600 teeth per square inch, overall length 14" (35.6cm)

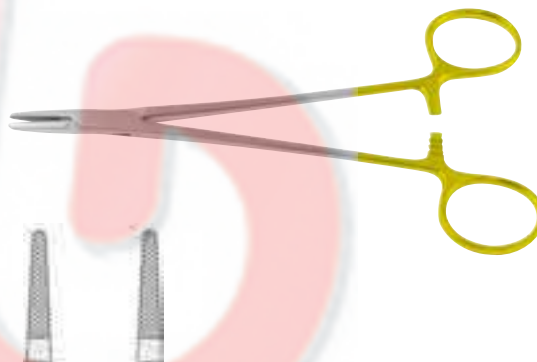

## BAUMGARTNER NEEDLE HOLDERS

Tungsten carbide inserts.  
2,500 teeth per square inch.

Item Number	Description
MDS2415412	Overall length $5\frac{1}{8}$ " (13cm)





### DERF EYE NEEDLE HOLDER

Tungsten carbide inserts.  
3,600 teeth per square inch.

Item Number	Description
MDS2411412	Overall length 4 <sup>3</sup> / <sub>4</sub> " (12.1cm)



### MAYO-HEGAR NEEDLE HOLDERS

Tungsten carbide inserts. 2,500 teeth per square inch.

Item Number	Description
MDS2418416	Overall length 6 <sup>1</sup> / <sub>4</sub> " (15.9cm)
MDS2418418	Overall length 7 <sup>1</sup> / <sub>4</sub> " (18.4cm)
MDS2418420	Overall length 8" (20.3cm)
MDS2418424	Overall length 9 <sup>1</sup> / <sub>4</sub> " (23.5cm)
MDS2418430	Overall length 11 <sup>3</sup> / <sub>4</sub> " (29.8cm)
MDS2418435	Overall length 14" (35.6cm)
MDS2418440	Overall length 16" (41cm)

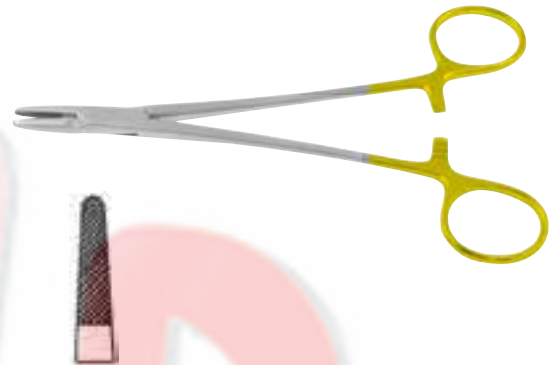

### NEW ORLEANS NEEDLE HOLDER

Tungsten carbide inserts.  
2,500 teeth per square inch.

Item Number	Description
MDS2419818	Overall length 7" (17.8cm)

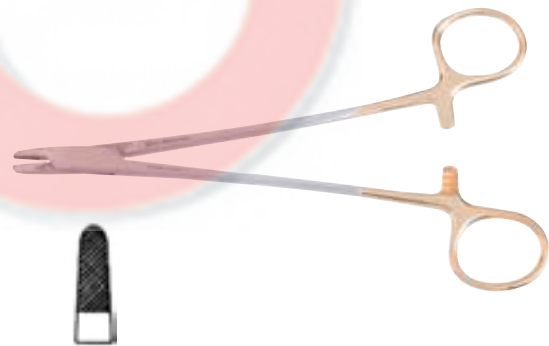

### FRENCH EYE NEEDLE HOLDERS

Tungsten carbide inserts.  
2,500 teeth per square inch.

Item Number	Description
MDS2422413	Overall length 5" (13cm)
MDS2422415	Overall length 6 <sup>1</sup> / <sub>4</sub> " (15.9cm)
MDS2422418	Overall length 7 <sup>1</sup> / <sub>4</sub> " (18.4cm)
MDS2422420	Overall length 8" (20.3cm)
MDS2422423	Overall length 9" (23cm)
MDS2422426	Overall length 10 <sup>1</sup> / <sub>4</sub> " (26cm)

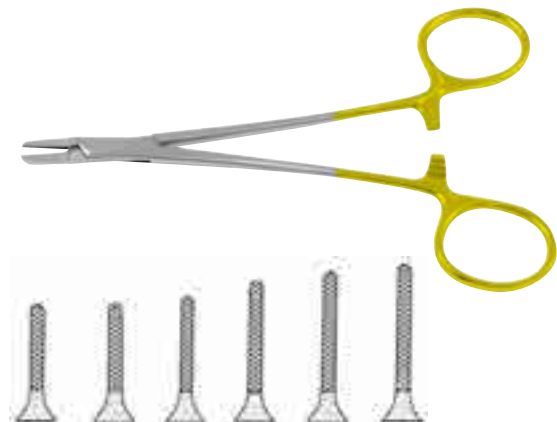

## ROCHESTER NEEDLE HOLDER

Light and fine. Straight jaws.  
Tungsten carbide inserts.  
3,600 teeth per square inch.

<u>Item Number</u>	<u>Description</u>
MDS2423418	Overall length 7 <sup>1</sup> / <sub>8</sub> " (18.1cm)



## JULIAN NEEDLE HOLDERS

Light and fine. Tungsten carbide inserts.  
3,600 teeth per square inch. Overall length 8" (20.3cm).

<u>Item Number</u>	<u>Description</u>
MDS0652820	Straight jaws
MDS0652920	Curved jaws

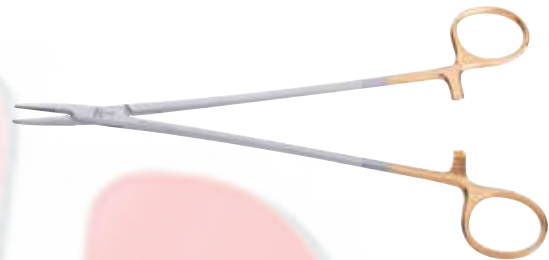

## SAROT NEEDLE HOLDERS

Tungsten carbide inserts.  
3,600 teeth per square inch.

<u>Item Number</u>	<u>Description</u>
MDS2432426	Overall length 10 <sup>3</sup> / <sub>8</sub> " (26.3cm)
MDS2432418	Overall length 7 <sup>1</sup> / <sub>8</sub> " (18.1cm)

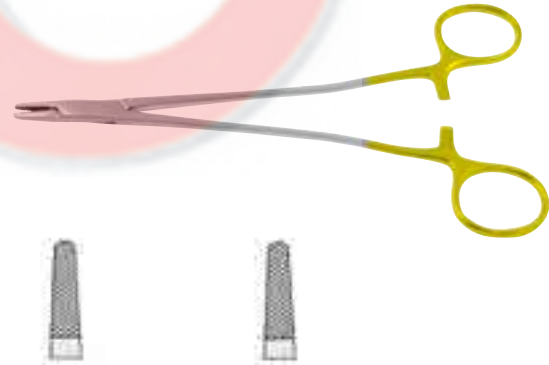

## MASSON NEEDLE HOLDER

Tungsten carbide inserts.  
2,500 teeth per square inch.

<u>Item Number</u>	<u>Description</u>
MDS2425427	Overall length 10 <sup>3</sup> / <sub>8</sub> " (26.3cm)



## HEANEY NEEDLE HOLDERS

Curved. Tungsten carbide inserts.  
2,500 teeth per square inch.

Item Number	Description
MDS2424521	Overall length 8" (20.3cm)
MDS2424526	Overall length 10½" (26.7cm)
MDS2424530	Overall length 12" (30.5cm)
MDS2424536	Overall length 14" (35.6cm)

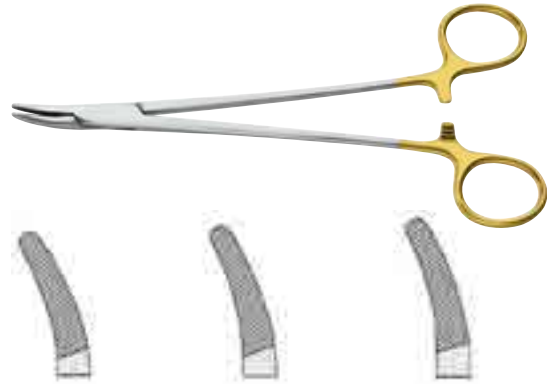

## FINOCHIETTO NEEDLE HOLDERS

Tungsten carbide inserts.  
3,600 teeth per square inch.

Item Number	Description
MDS2431520	Overall length 8" (20.3cm)
MDS2431527	Overall length 10½" (26.7cm)

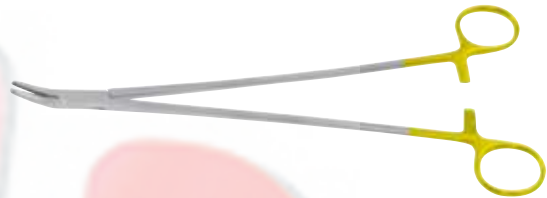

## WANGENSTEEN NEEDLE HOLDER

Straight jaws. Tungsten carbide inserts.  
3,600 teeth per square inch.

Item Number	Description
MDS2426427	Overall length 10¾" (27.3cm)

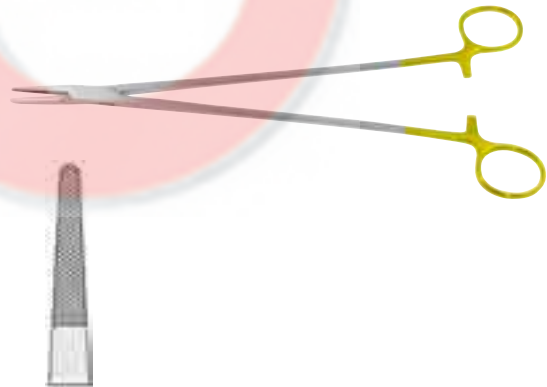

## CASTROVIEJO NEEDLE HOLDERS

Jaw length 9mm. With lock. Tungsten carbide inserts.  
3,600 teeth per square inch. Overall length 5½" (14cm).

Item Number	Description
MDS2467614	Straight
MDS2467714	Curved





## MILLS VASCULAR NEEDLE HOLDERS

Round Barraquer handles. Spring handle.  
Flat lock. Smooth Tungsten carbide inserts.  
Overall length 8" (20.3cm).

Item Number	Description
-------------	-------------

MDS0657620	Straight
------------	----------

MDS0657720	Curved
------------	--------



## MICROSURGERY NEEDLE HOLDERS

Spring handle. Straight jaws.  
Smooth tungsten carbide inserts.

Item Number	Description
-------------	-------------

MDS2467414	Straight jaws, flat lock, overall length 5 <sup>3</sup> / <sub>4</sub> " (14.6cm)
------------	--

MDS2467814	Straight jaws, without lock, overall length 5 <sup>3</sup> / <sub>4</sub> " (14.6cm)
------------	---

MDS2467418	Straight jaws, flat lock, overall length 7 <sup>1</sup> / <sub>4</sub> " (18.4cm)
------------	--

MDS2467514	Curved jaws, flat lock, overall length 5 <sup>5</sup> / <sub>8</sub> " (14.3cm)
------------	--



## COOLEY MICROVASCULAR NEEDLE HOLDERS

Very fine, straight jaws. Indented shanks.  
Tungsten carbide inserts.

Item Number	Description
-------------	-------------

MDS0651815	Smooth inserts, overall length 6" (15.2cm)
------------	---

MDS0651915	Serrated inserts, 3,600 teeth per square inch, overall length 6" (15.2cm)
------------	---

MDS0651817	Smooth inserts, overall length 6 <sup>3</sup> / <sub>4</sub> " (17.1cm)
------------	--

MDS0651917	Serrated inserts, 3,600 teeth per square inch, overall length 6 <sup>3</sup> / <sub>4</sub> " (17.1cm)
------------	--

MDS0651820	Smooth inserts, overall length 8" (20.3cm)
------------	---

MDS0651920	Serrated inserts, 3,600 teeth per square inch, overall length 8" (20.3cm)
------------	---

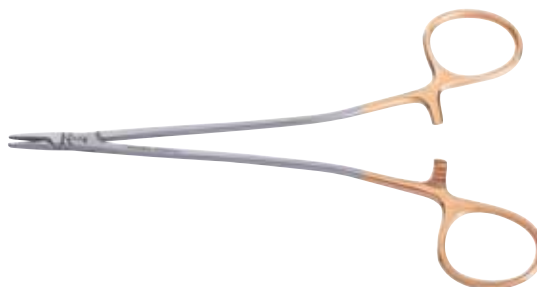

## RYDER NEEDLE HOLDERS

Narrow jaws. Tungsten carbide inserts.  
Gold plate and satin finish.

Item Number	Description
MDS2422513	Smooth inserts, overall length 5" (12.7cm)
MDS2422515	Smooth inserts, overall length 6" (15.2cm)
MDS2422518	Smooth inserts, overall length 7" (17.8cm)
MDS2422520	Smooth inserts, overall length 8" (20.3cm)
MDS2422523	Smooth inserts, overall length 9" (22.9cm)
MDS2422213	Serrated inserts, 3,600 teeth per square inch, overall length 5" (12.7cm)
MDS2422215	Serrated inserts, 3,600 teeth per square inch, overall length 6" (15.2cm)
MDS2422218	Serrated inserts, 3,600 teeth per square inch, overall length 7" (17.8cm)
MDS2422220	Serrated inserts, 3,600 teeth per square inch, overall length 8" (20.3cm)
MDS2422223	Serrated inserts, 3,600 teeth per square inch, overall length 9" (22.9cm)

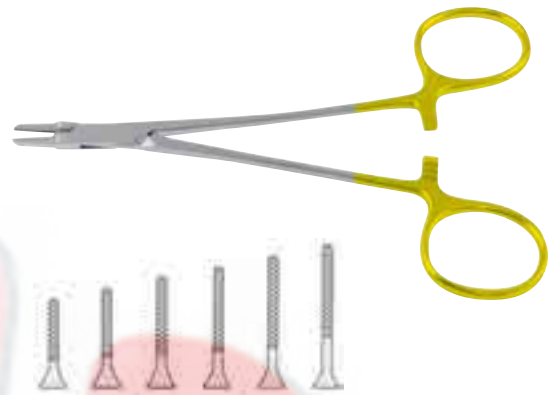

## CASTROVIEJO NEEDLE HOLDERS

Spring handle. Flat lock. Straight jaws.  
Tungsten carbide inserts. 3,600 teeth per square inch.

Item Number	Description
MDS2467618	Overall length 7 <sup>1</sup> / <sub>4</sub> " (18.4cm)
MDS2469521	Overall length 8 <sup>3</sup> / <sub>4</sub> " (22.2cm)



## SPENCER CORONARY NEEDLE HOLDER

Spring handle. Flat lock.  
Smooth tungsten carbide inserts.

Item Number	Description
MDS0636579	Overall length 7" (17.8cm)



## DEBAKEY CARDIOVASCULAR NEEDLE HOLDERS

Fine patterns. Straight. Tungsten carbide inserts.  
3,600 teeth per square inch.

<u>Item Number</u>	<u>Description</u>
MDS2421418	Overall length 7 <sup>1</sup> / <sub>8</sub> " (18.1cm)
MDS2421423	Overall length 9" (22.9cm)
MDS2421426	Overall length 10 <sup>3</sup> / <sub>8</sub> " (26.3cm)
MDS2421431	Overall length 11 <sup>3</sup> / <sub>4</sub> " (29.8cm)

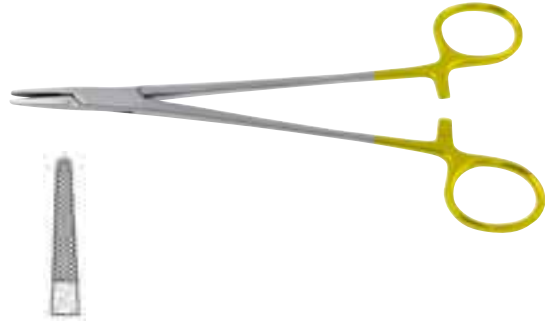

## MICROVASCULAR NEEDLE HOLDERS

Straight jaws, serrated. Tungsten carbide inserts.  
3,600 teeth per square inch.

<u>Item Number</u>	<u>Description</u>
MDS2442418	Overall length 7 <sup>1</sup> / <sub>8</sub> " (18.1cm)
MDS2442420	Overall length 8" (20.3cm)
MDS2442423	Overall length 9" (22.9cm)
MDS2442426	Overall length 10 <sup>1</sup> / <sub>4</sub> " (26cm)

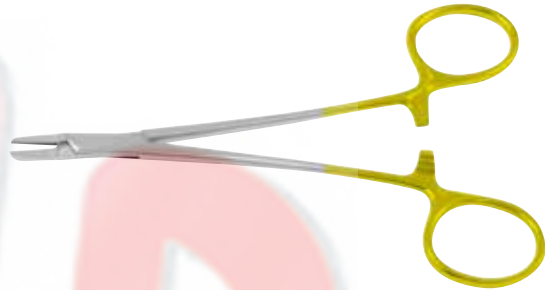

## COOLEY-BAUMGARTEN WIRE TWISTER

Heavy, blunt jaws. Tungsten carbide inserts.  
3,600 teeth per square inch.

<u>Item Number</u>	<u>Description</u>
MDS2400020	Overall length 8" (20.3cm)

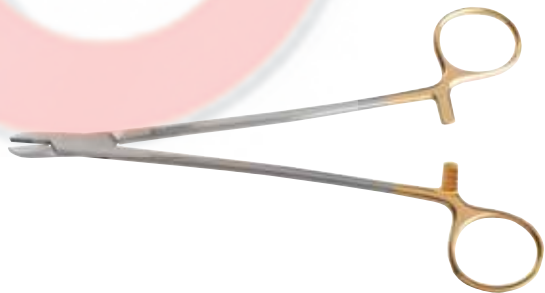

## WIRE TWISTERS

Rounded jaws. Tungsten carbide inserts.  
3,600 teeth per square inch. Overall length 6" (15.2cm).

<u>Item Number</u>	<u>Description</u>
MDS2480113	Fine
MDS2480013	Heavy





## RUBIO WIRE TWISTER

Tungsten carbide inserts.  
3,600 teeth per square inch.

Item Number	Description
MDS2412535	Overall length 5¼" (13.3cm)



## DRESSING FORCEPS

Serrated.

Item Number	Description
MDS1010211	Overall length 4¾" (12.1cm)
MDS1010213	Overall length 5" (12.7cm)
MDS1010214	Overall length 5½" (14cm)
MDS1010216	Overall length 6" (15.2cm)
MDS1010218	Overall length 7" (18cm)
MDS1010220	Overall length 8" (20.3cm)
MDS1010223	Overall length 9" (22.9cm)
MDS1010225	Overall length 10" (25.4cm)
MDS1010230	Overall length 12" (30.5cm)



## DRESSING FORCEPS

Curved, serrated.

Item Number	Description
MDS1011114	Overall length 5½" (14cm)



## TISSUE FORCEPS

1 x 2 teeth.

<u>Item Number</u>	<u>Description</u>
MDS1012011	Overall length 4 <sup>5</sup> / <sub>8</sub> " (11.7cm)
MDS1012013	Overall length 5" (12.7cm)
MDS1012014	Overall length 5 <sup>3</sup> / <sub>4</sub> " (14.6cm)
MDS1012016	Overall length 6" (15.2cm)
MDS1012018	Overall length 7" (18cm)
MDS1012020	Overall length 8" (20.3cm)
MDS1012025	Overall length 10" (25.4cm)
MDS1012030	Overall length 12" (30.5cm)
MDS1012040	Overall length 16" (40.6cm)

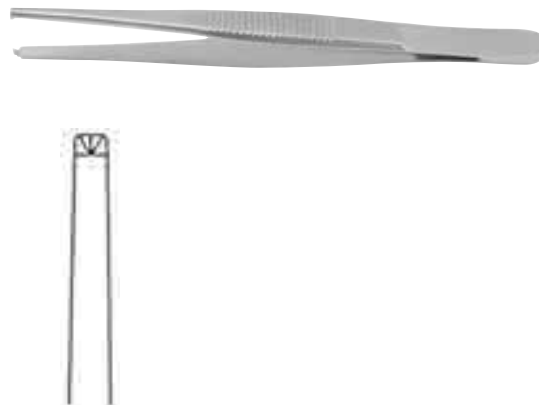

## TISSUE FORCEPS

2 x 3 teeth.

<u>Item Number</u>	<u>Description</u>
MDS1014011	Overall length 4 <sup>1</sup> / <sub>2</sub> " (11.4cm)
MDS1014013	Overall length 5" (12.7cm)
MDS1014014	Overall length 5 <sup>1</sup> / <sub>2</sub> " (14cm)
MDS1014016	Overall length 6" (15.2cm)



## TISSUE FORCEPS

3 x 4 teeth.

<u>Item Number</u>	<u>Description</u>
MDS1015013	Overall length 5" (12.7cm)
MDS1015014	Overall length 5 <sup>1</sup> / <sub>2</sub> " (14cm)
MDS1015016	Overall length 6" (15.2cm)



## TISSUE FORCEPS

1 x 2 teeth with serrations.

<u>Item Number</u>	<u>Description</u>
MDS1027215	Overall length 6" (15.2cm)



## SEMKEN TISSUE FORCEPS

Fine. Overall length  $4\frac{7}{8}$ " (12.4cm).

<u>Item Number</u>	<u>Description</u>
MDS1027012	1 x 2 teeth
MDS1027115	2 x 3 teeth



## CARMODY TISSUE FORCEPS

Fine serrations on jaws. 1 x 2 teeth.

<u>Item Number</u>	<u>Description</u>
MDS1020216	Overall length $6\frac{1}{4}$ " (15.9cm)



## SEMKEN DRESSING FORCEPS

Fine, serrated.

<u>Item Number</u>	<u>Description</u>
MDS1026012	Overall length $4\frac{7}{8}$ " (12.4cm)



## CASSIDY-BROPHY DRESSING FORCEPS

Fine.

<u>Item Number</u>	<u>Description</u>
MDS1019620	Overall length 8" (20.3cm)





## BROWN-BAHNSON FORCEPS

Bayonet. Mirror finish.

<u>Item Number</u>	<u>Description</u>
MDS1023515	Overall length 6" (15.2cm)
MDS1023520	Overall length 8" (20.3cm)



## POTTS-SMITH DRESSING FORCEPS

Fine, serrated tips.

<u>Item Number</u>	<u>Description</u>
MDS1011218	Overall length 7" (17.8cm)
MDS1011221	Overall length 8 <sup>1</sup> / <sub>4</sub> " (21cm)
MDS1011224	Overall length 9 <sup>1</sup> / <sub>2</sub> " (24.1cm)
MDS1011225	Overall length 10 <sup>1</sup> / <sub>4</sub> " (26cm)
MDS1011230	Overall length 12" (30.5cm)
MDS1011235	Overall length 14" (35.6cm)



## POTTS-SMITH TISSUE FORCEPS

Fine, serrated tips. 1 x 2 teeth.

<u>Item Number</u>	<u>Description</u>
MDS1012618	Overall length 7" (17.8cm)
MDS1012621	Overall length 8 <sup>1</sup> / <sub>4</sub> " (21cm)
MDS1012624	Overall length 9 <sup>1</sup> / <sub>2</sub> " (24.1cm)
MDS1012625	Overall length 10 <sup>1</sup> / <sub>4</sub> " (26cm)
MDS1012630	Overall length 12" (30.5cm)
MDS1012635	Overall length 14" (35.6cm)

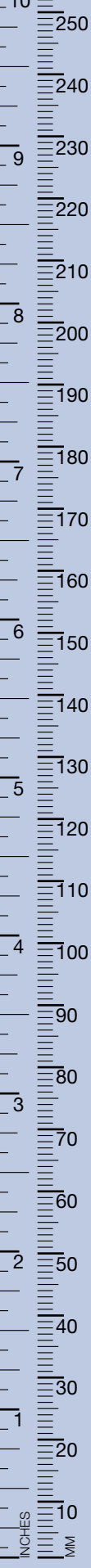

## ADSON FORCEPS

Fine. Overall length 4<sup>3</sup>/<sub>4</sub>" (12.1cm).

<u>Item Number</u>	<u>Description</u>
MDS1018012	No serrations
MDS1014412	Extra serrations

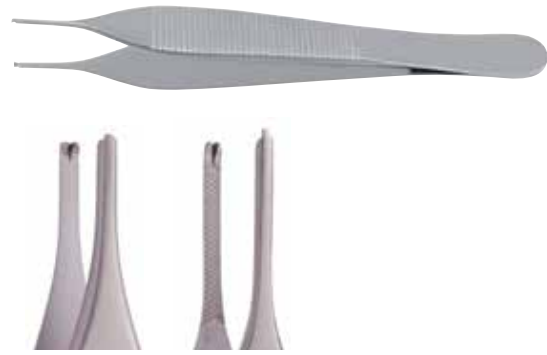

## ADSON MICRO FORCEPS

Overall length 4<sup>3</sup>/<sub>4</sub>" (12.1cm).

<u>Item Number</u>	<u>Description</u>
MDS1017612	Serrated jaws
MDS1018612	1 x 2 teeth



## CUSHING DRESSING FORCEPS

Serrated. Semi-sharp dissecting end.

<u>Item Number</u>	<u>Description</u>
MDS1022017	Overall length 7" (17.8cm)
MDS1022020	Overall length 8" (20.3cm)

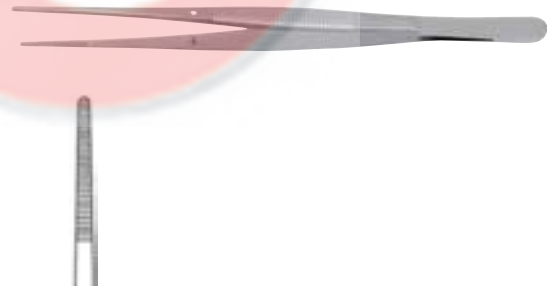

## BROWN-ADSON TISSUE FORCEPS

<u>Item Number</u>	<u>Description</u>
MDS1018812	Overall length 4 <sup>7</sup> / <sub>8</sub> " (12.4cm)



## ADSON DRESSING FORCEPS

Serrated.

<u>Item Number</u>	<u>Description</u>
MDS1017012	Overall length 4 $\frac{3}{4}$ " (12.1cm)



## HUDSON DRESSING FORCEPS

Overall length 4 $\frac{7}{8}$ " (12.4cm).

<u>Item Number</u>	<u>Description</u>
MDS1012390	Serrated
MDS1012391	1 x 2 teeth



## CUSHING TISSUE FORCEPS

1 x 2 teeth. Semi-sharp dissecting end.

<u>Item Number</u>	<u>Description</u>
MDS1023017	Overall length 7 $\frac{1}{4}$ " (18.4cm)
MDS1023020	Overall length 8" (20.3cm)

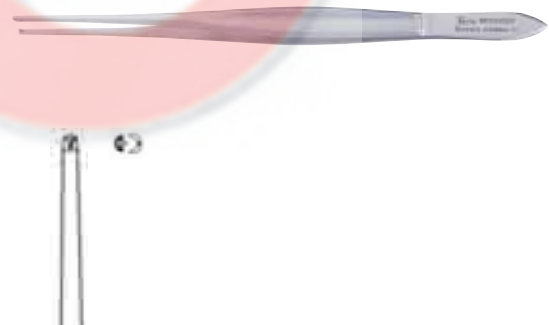

## RUSSIAN TISSUE FORCEPS

<u>Item Number</u>	<u>Description</u>
MDS1025615	Overall length 6" (15.2cm)
MDS1025620	Overall length 8" (20.3cm)
MDS1025625	Overall length 10" (25.4cm)
MDS1025630	Overall length 12" (30.5cm)
MDS1025635	Overall length 14" (35.6cm)

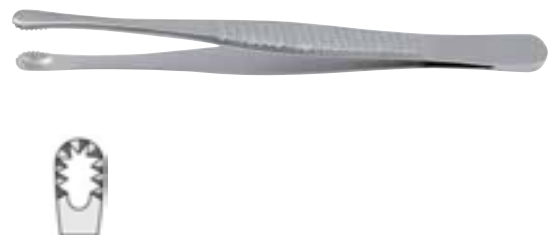

### C.W. MAYO TISSUE FORCEPS

Fenestrated. Russian-style tip.

Item Number	Description
MDS1045623	Overall length 9" (22.9cm)



### MARTIN TISSUE FORCEPS

7 x 8 teeth.

Item Number	Description
MDS1032215	Overall length 6" (15.2cm)
MDS1032218	Overall length 7" (17.8cm)



### FERRIS SMITH TISSUE FORCEPS

Overall length 6<sup>3</sup>/<sub>4</sub>" (17.1cm).

Item Number	Description
MDS1024818	2 x 3 teeth, heavy
MDS1024618	1 x 2 teeth

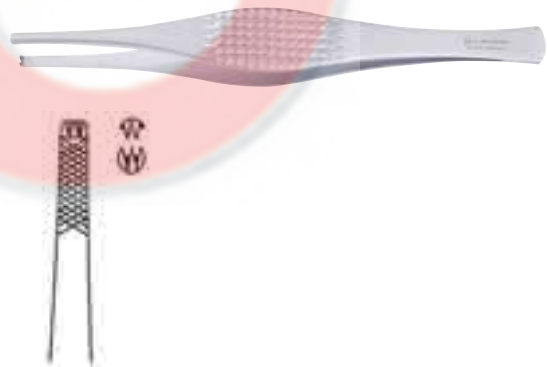

### BROWN TISSUE FORCEPS

7 x 8 teeth.

Item Number	Description
MDS1018915	Overall length 6 <sup>1</sup> / <sub>8</sub> " (15.6cm)
MDS1018920	Overall length 8" (20.3cm)





## HEANEY TISSUE FORCEPS

Item Number	Description
MDS1024114	2 x 3 teeth, overall length 5½" (14cm)
MDS1024219	3 x 4 teeth, overall length 7½" (19.1cm)
MDS1024119	1 x 2 teeth, overall length 7½" (19.1cm)



## SINGLEY TISSUE FORCEPS

Fenestrated, serrated jaws.

Item Number	Description
MDS1032015	Overall length 6" (15.2cm)
MDS1032018	Overall length 7" (17.8cm)
MDS1032023	Overall length 9¾" (24.8cm)
MDS1032035	Overall length 14" (35.6cm)
MDS1032040	Overall length 16" (40.6cm)



## DEBAKEY-DIETHRICH VASCULAR TISSUE FORCEPS

Extra-fine tips, 1mm wide.

Item Number	Description
MDS1131615	Overall length 6" (15.2cm)
MDS1131620	Overall length 7¾" (19.7cm)
MDS1131624	Overall length 9½" (24.1cm)



## DEBAKEY VASCULAR TISSUE FORCEPS

Fine jaws. Tips 1.5mm wide.

Item Number	Description
MDS1130616	Overall length 6" (15.2cm)
MDS1130620	Overall length 7¾" (19.7cm)
MDS1130624	Overall length 9½" (24.1cm)
MDS1130630	Overall length 12" (30.5cm)



## DEBAKEY TISSUE FORCEPS

Jaws 2mm wide.

Item Number	Description
MDS1130816	Overall length 6 <sup>1</sup> / <sub>4</sub> " (15.9cm)
MDS1130820	Overall length 7 <sup>3</sup> / <sub>4</sub> " (19.7cm)
MDS1130824	Overall length 9 <sup>1</sup> / <sub>2</sub> " (24.1cm)
MDS1130830	Overall length 12" (30.5cm)



## DEBAKEY VASCULAR TISSUE FORCEPS

Heavy jaws taper from 2.5mm wide.

Item Number	Description
MDS1130416	Overall length 6 <sup>1</sup> / <sub>4</sub> " (15.9cm)
MDS1130420	Overall length 7 <sup>3</sup> / <sub>4</sub> " (19.7cm)
MDS1130424	Overall length 9 <sup>1</sup> / <sub>2</sub> " (24.1cm)



## CURTIS TISSUE FORCEPS

1 x 2 teeth, with serrations. Heavy.

Item Number	Description
MDS1041022	Overall length 8 <sup>3</sup> / <sub>4</sub> " (22.2cm)



## BONNEY TISSUE FORCEPS

1 x 2 teeth.

Item Number	Description
MDS1045118	Overall length 6 <sup>3</sup> / <sub>4</sub> " (17.1cm)

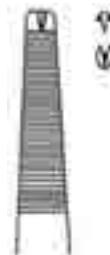

## ADSON DRESSING FORCEPS

Tungsten carbide inserts. 3600 teeth per square inch.

Item Number	Description
MDS1017412	Overall length 4 <sup>3</sup> / <sub>4</sub> " (12.1cm)
MDS1017415	Overall length 6" (15.2cm)
MDS1000112	Extra serrated, overall length 4 <sup>3</sup> / <sub>4</sub> " (12.1cm)



## ADSON TISSUE FORCEPS

Tungsten carbide inserts. 3600 teeth per square inch.  
1 x 2 teeth.

Item Number	Description
MDS1000212	Overall length 4 <sup>3</sup> / <sub>4</sub> " (12.1cm)
MDS1000215	Overall length 6" (15.2cm)



## TISSUE FORCEPS

Cross-serrated jaws. Tungsten carbide inserts.  
2,500 teeth per square inch.

Item Number	Description
MDS1026215	Overall length 6" (15.2cm)

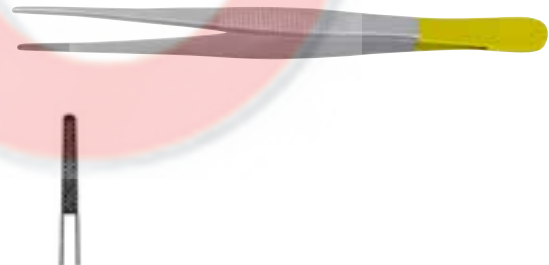

## POTTS-SMITH FORCEPS

Fine. Tungsten carbide inserts.  
3,600 teeth per square inch.

Item Number	Description
MDS1011618	Overall length 7" (17.8cm)
MDS1011620	Overall length 8" (20.3cm)
MDS1011623	Overall length 9" (22.9cm)
MDS1011624	Overall length 9 <sup>1</sup> / <sub>2</sub> " (24.1cm)
MDS1011626	Overall length 10 <sup>1</sup> / <sub>4</sub> " (26cm)



## WANGENSTEEN TISSUE FORCEPS

Tungsten carbide inserts. 2,500 teeth per square inch.

Item Number	Description
MDS1132615	Overall length 6" (15.2cm)
MDS1132623	Overall length 9" (22.9cm)
MDS1132625	Overall length 10" (25.4cm)



## CUSHING TISSUE FORCEPS

Bayonet. Tungsten carbide tips and dissecting end.

Item Number	Description
MDS1022503	Overall length 7 <sup>1</sup> / <sub>4</sub> " (18.5cm)



## CUSHING TISSUE FORCEPS

Fine jaws. Tungsten carbide inserts.  
3,600 teeth per square inch.

Item Number	Description
MDS1022502	Straight, overall length 7" (17.8cm)
MDS1022501	Angled tips, overall length 6 <sup>3</sup> / <sub>4</sub> " (17cm)

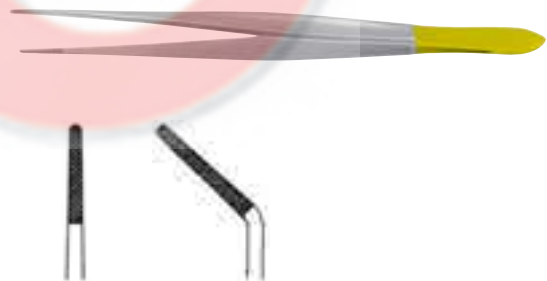

## WAUGH FORCEPS

Item Number	Description
MDS1000130	Overall length 8" (20.3cm)
MDS1000030	1 x 2 teeth, overall length 8" (20.3cm)





## SPLINTER FORCEPS

Sharp, serrated tips, fine.

<u>Item Number</u>	<u>Description</u>
MDS1080208	Overall length 3" (7.6cm)
MDS1080209	Overall length 3½" (8.9cm)
MDS1080210	Overall length 4¼" (10.8cm)
MDS1080211	Overall length 4½" (11.4cm)



## FEILCHENFELD SPLINTER FORCEPS

Serrated, cupped tips, fine.

<u>Item Number</u>	<u>Description</u>
MDS1081007	Overall length 3" (7.6cm)
MDS1081011	Overall length 4½" (11.4cm)

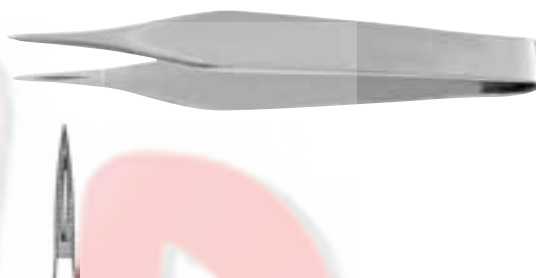

## WALTER SPLINTER FORCEPS

Triangular tips, fine. Overall length 4" (10.2cm).

<u>Item Number</u>	<u>Description</u>
MDS1081610	Straight
MDS1081710	Angled

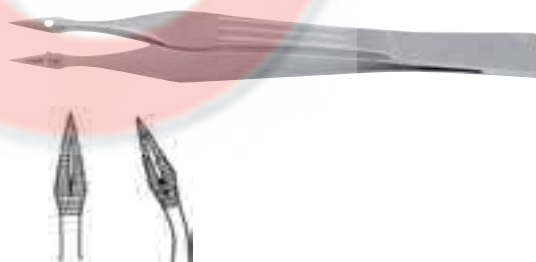

## VIRTUS SPLINTER FORCEPS

<u>Item Number</u>	<u>Description</u>
MDS1082815	Overall length 6" (15.2cm)

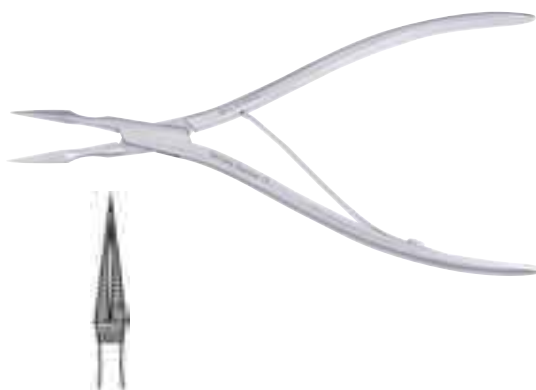

## MICRO GERALD FORCEPS

Fine tips tapered to 1mm wide.

Item Number	Description
MDS1014518	Overall length 7" (17.8cm)



## GERALD FORCEPS

Fine, extra-fine tips tapered to 1mm wide.

Item Number	Description
MDS1014318	Overall length 7" (17.8cm)
MDS1014323	Overall length 9" (22.9cm)



## DEBAKEY NEEDLE PULLING TISSUE FORCEPS

Flat handle. DeBakey jaws with Tungsten carbide inserts.

Item Number	Description
MDS1045915	Tips 2mm wide, overall length 6" (15.2cm)
MDS1045920	Tips 2mm wide, overall length 7 <sup>3</sup> / <sub>4</sub> " (19.7cm)
MDS1045924	Tips 2mm wide, overall length 9 <sup>1</sup> / <sub>2</sub> " (24.1cm)
MDS1045815	Tips 1.5mm wide, overall length 6" (15.2cm)
MDS1045820	Tips 1.5mm wide, overall length 7 <sup>3</sup> / <sub>4</sub> " (19.7cm)
MDS1045824	Tips 1.5mm wide, overall length 9 <sup>1</sup> / <sub>2</sub> " (24.1cm)



## DEBAKEY VASCULAR TISSUE FORCEPS

Angled. Jaws taper from 2mm.

Item Number	Description
MDS1130916	Overall length 6" (15.2cm)
MDS1130920	Overall length 7 <sup>3</sup> / <sub>4</sub> " (19.7cm)
MDS1130924	Overall length 9 <sup>1</sup> / <sub>2</sub> " (24.1cm)
MDS1130925	Overall length 10" (25.4cm)



## JEWELERS FORCEPS

Straight. With tying platform. Tip diameter 0.3mm.

<u>Item Number</u>	<u>Description</u>
MDS3840111	Flat handle, 9mm wide, overall length 7" (18cm)
MDS3849011	Flat handle, 9mm wide, overall length 5½" (14cm)
MDS3849071	Flat handle, 9mm wide, overall length 5¼" (13.5cm)
MDS3849061	Flat handle, 7mm wide, overall length 5¼" (13.5cm)



## JEWELERS FORCEPS

Straight.

<u>Item Number</u>	<u>Description</u>
MDS3848901	Tip diameter 0.8mm, flat handle, 9mm wide, overall length 4¾" (12cm)
MDS3849806	Tip diameter 0.6mm, flat handle, 9mm wide, overall length 4¾" (12cm)
MDS3849031	Tip diameter 0.3mm, flat handle, 9mm wide, overall length 4¾" (12cm)
MDS3840116	Tip diameter 0.3mm, flat handle, 9mm wide, overall length 7" (18cm)
MDS3849911	Tip diameter 0.4mm, flat handle, 9mm wide, overall length 4¼" (10.8cm)
MDS3849936	Tip diameter 0.3mm, flat handle, 9mm wide, overall length 4⅜" (11cm)
MDS3849016	Tip diameter 0.3mm, flat handle, 9mm wide, overall length 5½" (14cm)
MDS3849076	Tip diameter 0.3mm, flat handle, 9mm wide, overall length 5¼" (13.5cm)
MDS3849056	Tip diameter 0.3mm, flat handle, 7mm wide, overall length 5¼" (13.5cm)



## PIERSE-TYPE JEWELERS TISSUE FORCEPS

Straight. Flat handle, 9mm wide.

<b>Item Number</b>	<b>Description</b>
MDS3840436	Tip with 0.3mm-diameter hole, overall length 5 <sup>1</sup> / <sub>4</sub> " (13.5cm)
MDS3810426	Tip with 0.3mm-diameter hole, overall length 4 <sup>3</sup> / <sub>8</sub> " (11cm)
MDS3840431	Tip with 0.6mm-diameter hole, overall length 4 <sup>3</sup> / <sub>8</sub> " (11cm)
MDS3840461	Tip with 0.6mm-diameter hole, overall length 7" (18cm)
MDS3840456	Tip with 0.3mm-diameter hole, overall length 7" (18cm)
MDS3840451	Tip with 0.1mm-diameter hole, overall length 7" (18cm)



## HOOK FORCEPS

Flat handle. Overall length 4<sup>3</sup>/<sub>4</sub>" (12cm).

<b>Item Number</b>	<b>Description</b>
MDS3840201	Fine hooks
MDS3840321	Standard hooks



## MICROSURGICAL FORCEPS

Round handle.

<b>Item Number</b>	<b>Description</b>
MDS3827214	Straight, with tying platform, overall length 5 <sup>7</sup> / <sub>8</sub> " (15cm)
MDS4249461	Straight, without tying platform, overall length 5 <sup>7</sup> / <sub>8</sub> " (15cm)
MDS3849516	Curved, with tying platform, overall length 5 <sup>7</sup> / <sub>8</sub> " (15cm)
MDS3849466	Straight, with tying platform, overall length 7" (18cm)
MDS3849491	Straight, without tying platform, overall length 7" (18cm)
MDS4288912	Curved, with tying platform, overall length 7" (18cm)





## MICROSURGICAL FORCEPS

Straight. 1 x 2 teeth. Round handle.

<u>Item Number</u>	<u>Description</u>
MDS3849576	Overall length 7" (18cm)



## DILATOR FORCEPS

<u>Item Number</u>	<u>Description</u>
MDS3840376	Straight, tip diameter 0.2mm, flat handle, 9mm wide, overall length 7" (18cm)
MDS3840361	Straight, tip diameter 0.2mm, flat handle, 7mm wide, overall length 5 1/4" (13.5cm)
MDS3841376	Tip angled 10°, diameter 0.3mm, flat handle, 9mm wide, overall length 4 3/8" (11cm)
MDS3840301	Tip angled 10°, diameter 0.2mm, flat handle, 9mm wide, overall length 4 3/8" (11cm)



## VICKERS MICRO RING FORCEPS

Straight. Tip diameter 1mm. Round handle. Tungsten carbide inserts.

<u>Item Number</u>	<u>Description</u>
MDS3849716	Overall length 7" (18cm)
MDS3849726	Overall length 8 1/4" (21cm)



## HALSTED MICRO ARTERY FORCEPS

Fine. Overall length 5" (12.7cm).

<u>Item Number</u>	<u>Description</u>
MDS1231813	Straight jaws
MDS1231913	Curved jaws



## CRILE MICRO ARTERY FORCEPS

Fine. Overall length 5½" (14cm).

Item Number	Description
MDS1229114	Straight
MDS1229014	Curved



## PEAN MICRO ARTERY FORCEPS

Fine. Overall length 5½" (14cm).

Item Number	Description
MDS1231214	Straight
MDS1231314	Curved



## MIXTER MICRO PEDIATRIC FORCEPS

Fine and fine.

Item Number	Description
MDS1247514	Fully curved jaws, overall length 5¼" (13.3cm)
MDS1247614	Right-angled jaws, overall length 5" (12.8cm)
MDS1247714	Right-angled jaws, extra fine, overall length 5" (12.8cm)
MDS1247814	Curved, overall length 6" (15.2cm)
MDS1247414	Curved, overall length 5½" (14cm)

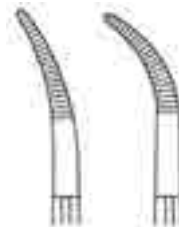

## ALLIS MICRO TISSUE FORCEPS

Light, fine.

Item Number	Description
MDS1244813	3 x 4 teeth, overall length 5" (12.7cm)
MDS1244815	4 x 5 teeth, overall length 5 <sup>3</sup> / <sub>4</sub> " (14.6cm)



## ALLEN MICRO INTESTINAL ANASTOMOSIS FORCEPS

Straight, fine. Jaws longitudinally serrated, 1 x 2 teeth.

Item Number	Description
MDS6422515	Overall length 6" (15.2cm)

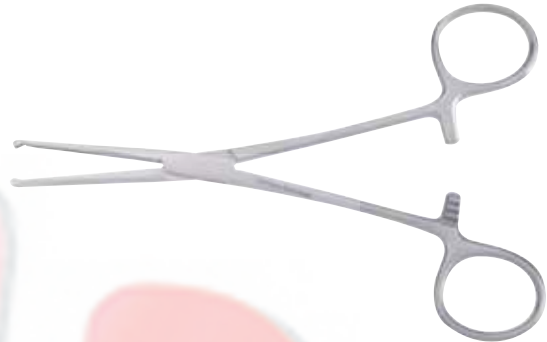

## KOCHER MICRO INTESTINAL FORCEPS

Longitudinal serrations. Overall length 5<sup>1</sup>/<sub>2</sub>" (14cm).

Item Number	Description
MDS6422013	Straight jaws
MDS6422113	Curved jaws

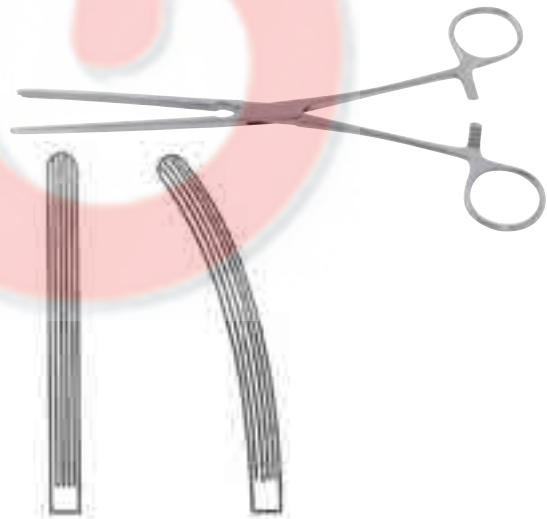

## HARTMAN MOSQUITO FORCEPS

Fine jaws. Overall length 4" (10.2cm).

Item Number	Description
MDS1221010	Straight jaws
MDS1221110	Curved jaws



## JACOBSON MOSQUITO FORCEPS

Very fine. Overall length 5" (12.7cm).

Item Number	Description
MDS1229318	Straight jaws
MDS1229418	Curved jaws



## HALSTED MOSQUITO FORCEPS

Overall length 5" (12.7cm).

Item Number	Description
MDS1222012	Straight jaws
MDS1222112	Curved jaws



## HALSTED MOSQUITO FORCEPS

1 x 2 teeth. Overall length 4<sup>3</sup>/<sub>4</sub>" (12.2cm).

Item Number	Description
MDS1223012	Straight
MDS1223112	Curved

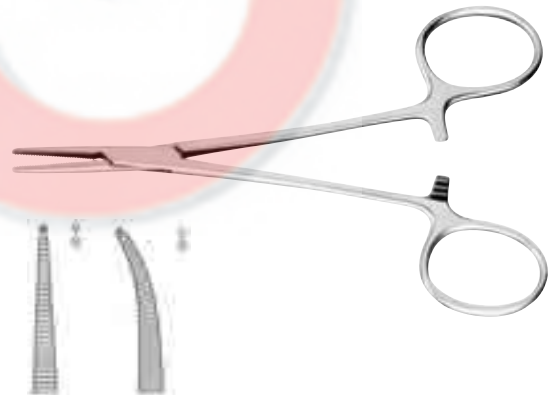

## PROVIDENCE HOSPITAL ARTERY FORCEPS

Overall length 5<sup>1</sup>/<sub>2</sub>" (14cm).

Item Number	Description
MDS1227014	Straight
MDS1227114	Curved





## KELLY ARTERY FORCEPS

Overall length 5½" (14cm).

Item Number	Description
-------------	-------------

MDS1224014	Straight
MDS1224114	Curved



## COLLER ARTERY FORCEPS

Crile-type forceps. Fine.

Item Number	Description
-------------	-------------

MDS1228014	Straight, overall length 5½" (14cm)
MDS1228114	Curved, overall length 5½" (14cm)
MDS1228016	Straight, overall length 6¼" (15.9cm)
MDS1228116	Curved, overall length 6¼" (15.9cm)
MDS1228018	Straight, overall length 7¼" (18.4cm)
MDS1228118	Curved, overall length 7¼" (18.4cm)



## COLLIER-ANDERSON CLAMPS

Curved.

Item Number	Description
-------------	-------------

MDS1228228	Overall length 10" (25.4cm)
MDS1228128	Overall length 11" (27.9cm)



## COLLER ARTERY FORCEPS

Jaw length 44mm, tip 2mm. Overall length 9½" (24.1cm).

Item Number	Description
-------------	-------------

MDS1228124	Curved
MDS1228324	Strongly curved
MDS1228524	Jaws angled 90°



## CRILE FORCEPS

Regular pattern.

<b>Item Number</b>	<b>Description</b>
MDS1225014	Straight, overall length 5½" (14cm)
MDS1226216	Straight, overall length 6¼" (15.9cm)
MDS1225114	Curved, overall length 5½" (14cm)
MDS1226316	Curved, overall length 6¼" (15.9cm)

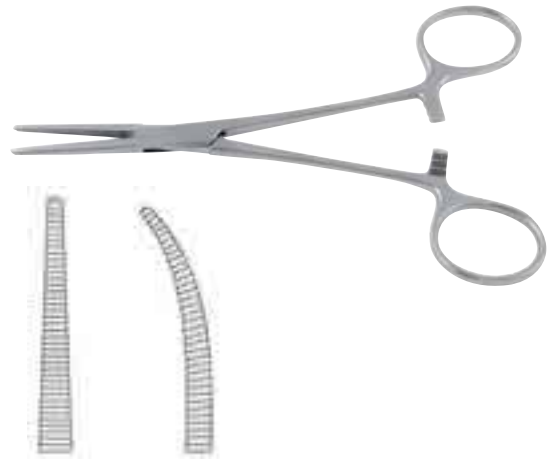

## ROCHESTER-RANKIN ARTERY FORCEPS

Straight. Light, with finely pointed jaws.

<b>Item Number</b>	<b>Description</b>
MDS1224216	Overall length 6¼" (15.9cm)

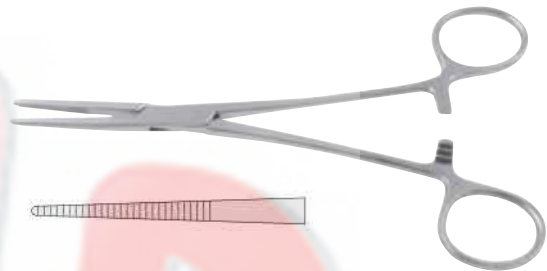

## RANKIN ARTERY FORCEPS

Curved.

<b>Item Number</b>	<b>Description</b>
MDS1224316	Overall length 6¼" (15.9cm)

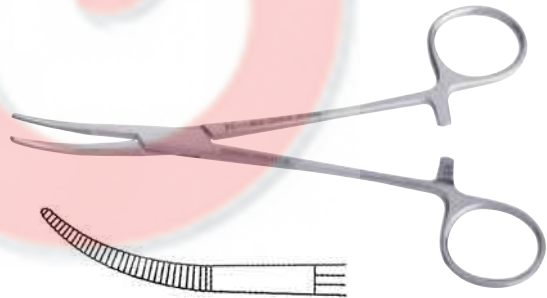

## CARMALT ARTERY FORCEPS

<b>Item Number</b>	<b>Description</b>
MDS1234016	Straight, overall length 6½" (16.5cm)
MDS1234020	Straight, overall length 8" (20.3cm)
MDS1234116	Curved, overall length 6½" (16.5cm)
MDS1234120	Curved, overall length 8" (20.3cm)
MDS1234130	Curved, overall length 12" (30.5cm)



## ROCHESTER-PEAN HYSTERECTOMY FORCEPS

Serrated.

Item Number	Description
MDS1231022	Straight, overall length 8 <sup>7</sup> / <sub>8</sub> " (22.5cm)
MDS1231026	Straight, overall length 10" (25.4cm)
MDS1231122	Curved, overall length 8 <sup>7</sup> / <sub>8</sub> " (22.5cm)
MDS1231126	Curved, overall length 10" (25.4cm)



## PEAN ARTERY FORCEPS

Item Number	Description
MDS1231016	Straight, overall length 6 <sup>1</sup> / <sub>2</sub> " (16.5cm)
MDS1231018	Straight, overall length 7 <sup>1</sup> / <sub>4</sub> " (18.4cm)
MDS1231020	Straight, overall length 8" (20.3cm)
MDS1231030	Straight, overall length 12" (30.5cm)
MDS1231116	Curved, overall length 6 <sup>1</sup> / <sub>2</sub> " (16.5cm)
MDS1231118	Curved, overall length 7 <sup>1</sup> / <sub>4</sub> " (18.4cm)
MDS1231120	Curved, overall length 8" (20.3cm)
MDS1231130	Curved, overall length 12" (30.5cm)
MDS1231135	Curved, overall length 14" (35.6cm)

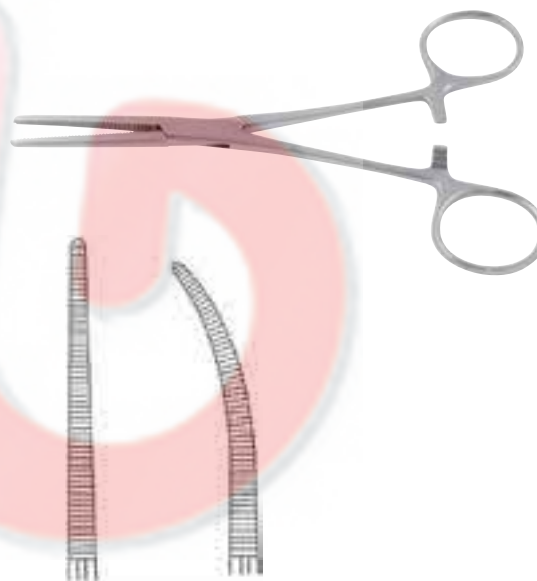

## KOCHER ARTERY FORCEPS

1 x 2 teeth. Overall length 5<sup>1</sup>/<sub>2</sub>" (14cm).

Item Number	Description
MDS1232214	Straight
MDS1232314	Curved, overall length 5 <sup>1</sup> / <sub>2</sub> " (14cm)

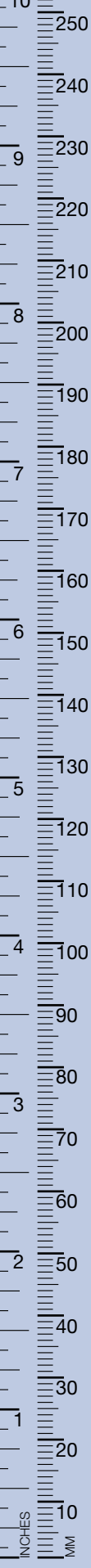
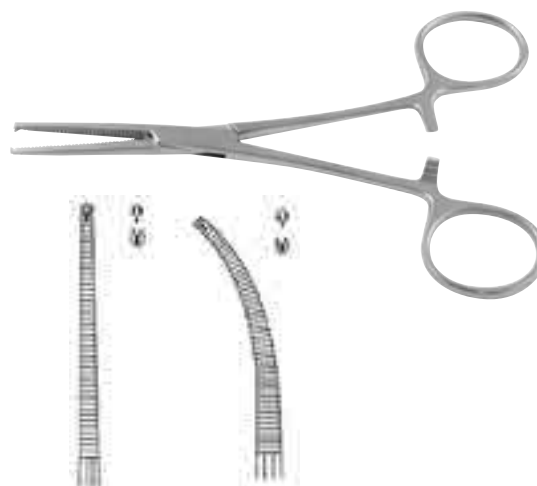

## OCHSNER ARTERY FORCEPS

1 x 2 teeth.

<b>Item Number</b>	<b>Description</b>
MDS1232016	Straight, overall length 6 $\frac{1}{4}$ " (15.9cm)
MDS1232018	Straight, overall length 7 $\frac{1}{4}$ " (18.4cm)
MDS1232020	Straight, overall length 8" (20.3cm)
MDS1232026	Straight, extra-long, overall length 10" (25.4cm)
MDS1232035	Straight, extra-long, overall length 14" (35.6cm)
MDS1232116	Curved, overall length 6 $\frac{1}{4}$ " (15.9cm)
MDS1232118	Curved, overall length 7 $\frac{1}{4}$ " (18.4cm)
MDS1232120	Curved, overall length 8" (20.3cm)
MDS1232126	Curved, extra-long, overall length 10" (25.4cm)



## BACKHAUS TOWEL FORCEPS

<b>Item Number</b>	<b>Description</b>
MDS1411109	Overall length 3 $\frac{1}{2}$ " (8.9cm)
MDS1411113	Overall length 5 $\frac{1}{4}$ " (13.3cm)

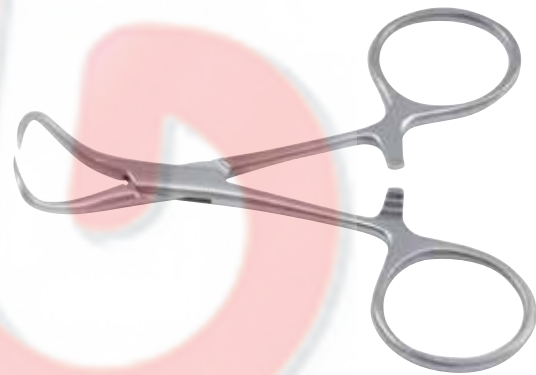

## ROEDER TOWEL FORCEPS

Ball stops.

<b>Item Number</b>	<b>Description</b>
MDS1411713	Overall length 5 $\frac{1}{2}$ " (14cm)



## JONES TOWEL FORCEPS

Cross-action.

<b>Item Number</b>	<b>Description</b>
MDS1410309	Overall length 3 $\frac{3}{8}$ " (8.5cm)



## NON-PERFORATING TOWEL FORCEPS

Item Number	Description
MDS1412511	Overall length 4" (10.2cm)
MDS1412513	Overall length 5 <sup>1</sup> / <sub>4</sub> " (13.3cm)

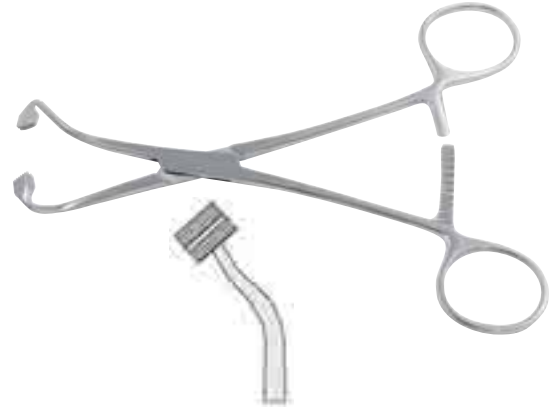

## LORNA NON-PERFORATING TOWEL FORCEPS

Edna-style.

Item Number	Description
MDS1412110	Overall length 3 <sup>7</sup> / <sub>8</sub> " (9.8cm)
MDS1412113	Overall length 5 <sup>1</sup> / <sub>4</sub> " (13.3cm)



## TUBING CLAMP FORCEPS

Heavier, with deep serrations designed to clamp off tubing safely and efficiently. Straight.

Item Number	Description
MDS1270214	Overall length 6 <sup>1</sup> / <sub>4</sub> " (15.9cm)

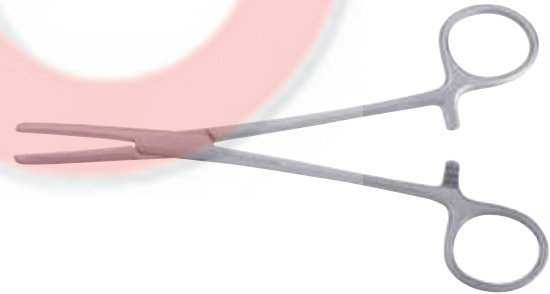

## TUBING CLAMP FORCEPS

Item Number	Description
MDS1271015	Tubing max O.D. <sup>3</sup> / <sub>8</sub> " (9.5mm) with wall <sup>1</sup> / <sub>32</sub> " (0.79mm) to <sup>1</sup> / <sub>16</sub> " (1.59mm), overall length 6" (15.2cm)
MDS1271018	Tubing max O.D. <sup>5</sup> / <sub>8</sub> " (16mm) with wall <sup>1</sup> / <sub>16</sub> " (1.59mm) to <sup>3</sup> / <sub>32</sub> " (2.4mm), overall length 7 <sup>1</sup> / <sub>2</sub> " (19.1cm)
MDS1271020	Tubing max O.D. <sup>7</sup> / <sub>8</sub> " (22mm) with wall <sup>3</sup> / <sub>32</sub> " (2.4mm) to <sup>1</sup> / <sub>8</sub> " (3mm), overall length 8" (20.3cm)





## TUBING CLAMP FORCEPS

With guard.

<b>Item Number</b>	<b>Description</b>
MDS1271215	For $\frac{3}{8}$ " (1cm) tubing, overall length 6" (15.2cm)
MDS1271218	For $\frac{5}{8}$ " (1.6cm) tubing, overall length $7\frac{1}{4}$ " (18.4cm)
MDS1271220	For $\frac{7}{8}$ " (2.2cm) tubing, overall length 8" (20.3cm)

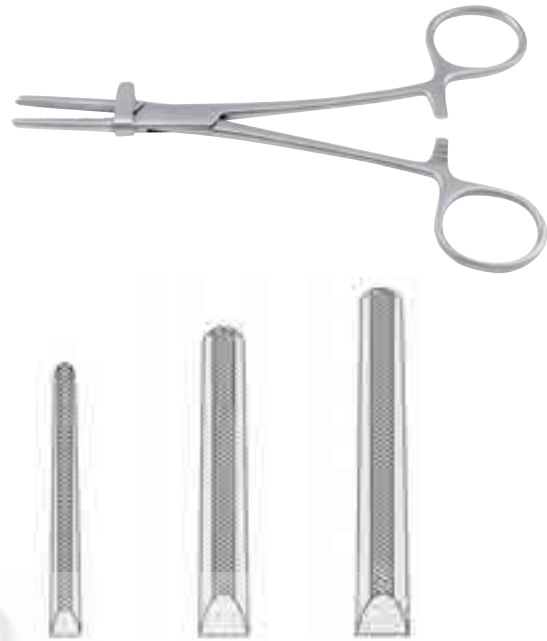

## ALLIS-OCHSNER TISSUE FORCEPS

3 x 4 fine teeth. Jaw 4mm wide.

<b>Item Number</b>	<b>Description</b>
MDS6414015	Overall length $5\frac{1}{2}$ " (14cm)

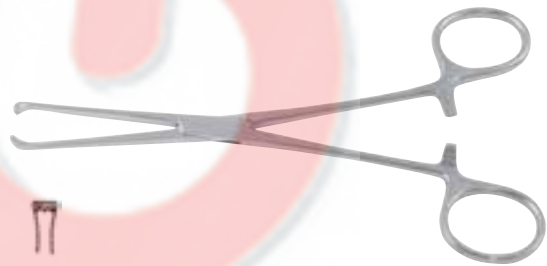

## BOYS-ALLIS TISSUE HOLDING FORCEPS

Heavy pattern, 5 x 6 teeth.

<b>Item Number</b>	<b>Description</b>
MDS6414815	Overall length 6" (15.2cm)



## ALLIS TISSUE FORCEPS

Item Number	Description
MDS6411015	4 x 5 teeth, overall length 6" (15.2cm)
MDS6412015	5 x 6 teeth, overall length 6" (15.2cm)
MDS6412019	Light pattern, 5 x 6 teeth, overall length 7½" (19.1cm)
MDS6412119	5 x 6 teeth, overall length 7½" (19.1cm)
MDS6412024	5 x 6 teeth, overall length 10" (25.4cm)
MDS6412030	5 x 6 teeth, overall length 12" (30.5cm)
MDS6412035	5 x 6 teeth, overall length 14" (35.6cm)
MDS6412040	5 x 6 teeth, overall length 16" (40.6cm)



## THOMS TISSUE FORCEPS

6 x 7 teeth.

Item Number	Description
MDS6415020	Overall length 8" (20.3cm)

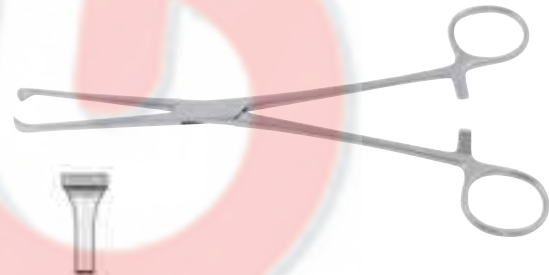

## BABCOCK TISSUE HOLDING FORCEPS

Item Number	Description
MDS6416016	Overall length 6¼" (15.9cm)
MDS6416019	Fine jaws, overall length 7½" (19.1cm)
MDS6416020	Jaws 10.4mm wide, overall length 8" (20.3cm)
MDS6416030	Overall length 12" (30.5cm)
MDS6416035	Overall length 14" (35.6cm)



## BABCOCK FORCEPS

Tungsten carbide inserts. 2,500 teeth per square inch.

Item Number	Description
MDS6416416	Overall length 6½" (16.5cm)
MDS6416420	Overall length 8¼" (20.9cm)



## TURNER-BABCOCK TISSUE FORCEPS

With solid jaws and atraumatic transverse grooves.

Item Number	Description
MDS6416224	Overall length 9½" (24.1cm)



## PETIT BABCOCK TISSUE FORCEPS

Item Number	Description
MDS6416013P	7.5mm jaw, extra delicate, overall length 5½" (14cm)
MDS6416016P	6mm jaw, overall length 5¼" (13.3cm)
MDS6416020P	7.5mm jaw, overall length 8" (20.3cm)
MDS6416024P	7.5mm jaw, overall length 9½" (24.1cm)

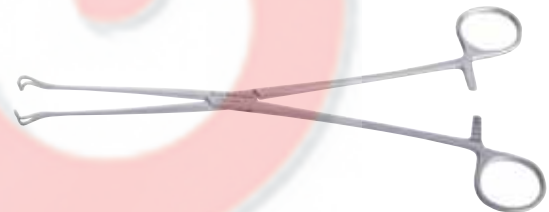

## COLLINS (DUVAL-CRILE) FORCEPS

Item Number	Description
MDS6417020	Jaws ½" (13mm), overall length 8" (20.3cm)
MDS6417220	Jaws 1" (25mm), overall length 8" (20.3cm)



## JUDD-ALLIS INTESTINAL TISSUE FORCEPS

<u>Item Number</u>	<u>Description</u>
MDS6414019	Overall length 7½" (19.1cm)



## LOCKWOOD INTESTINAL FORCEPS

Short.

<u>Item Number</u>	<u>Description</u>
MDS6415216	Overall length 6½" (16.5cm)



## DUVAL INTESTINAL FORCEPS

Serrated. Tungsten carbide inserts.

<u>Item Number</u>	<u>Description</u>
MDS6417420	Overall length 8" (20.4cm).

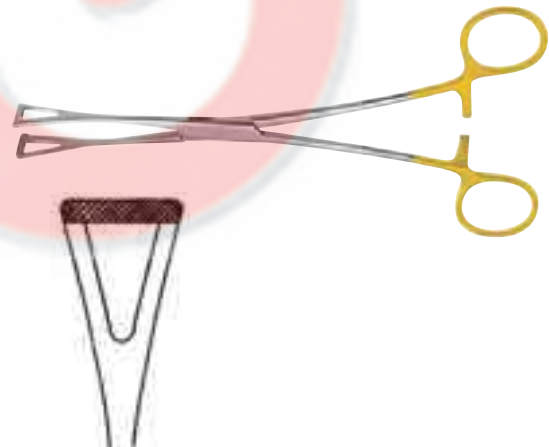

## WILLIAMS INTESTINAL FORCEPS

<u>Item Number</u>	<u>Description</u>
MDS6418016	Overall length 6½" (16.5cm)

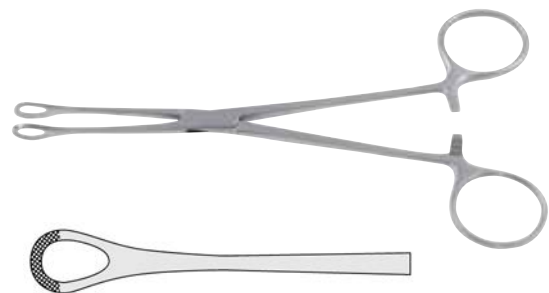

## BAINBRIDGE INTESTINAL FORCEPS

Longitudinal serrations.

<u>Item Number</u>	<u>Description</u>
MDS1248115	Straight, overall length 6" (15.2cm)
MDS1248118	Straight, overall length 7 <sup>1</sup> / <sub>4</sub> " (18.4cm)
MDS1248015	Curved, overall length 6" (15.2cm)
MDS1248018	Curved, overall length 7 <sup>1</sup> / <sub>4</sub> " (18.4cm)



## DENNIS ANASTOMOSIS CLAMP

Longitudinal serrations. Short jaw, length 2<sup>1</sup>/<sub>4</sub>" (5.7cm).

<u>Item Number</u>	<u>Description</u>
MDS6421424	Overall length 9 <sup>1</sup> / <sub>4</sub> " (23.5cm)



## ALLEN INTESTINAL CLAMP

Longitudinal serrations. 1 x 2 teeth.

<u>Item Number</u>	<u>Description</u>
MDS6422420	Overall length 8" (20.3cm)



## KOCHER INTESTINAL FORCEPS

Longitudinal serrations. Light.

<u>Item Number</u>	<u>Description</u>
MDS6422025	Straight, overall length 9 <sup>7</sup> / <sub>8</sub> " (25.1cm)
MDS6422028	Straight, overall length 10 <sup>1</sup> / <sub>2</sub> " (26.7cm)
MDS6422125	Curved, overall length 9 <sup>3</sup> / <sub>4</sub> " (24.8cm)

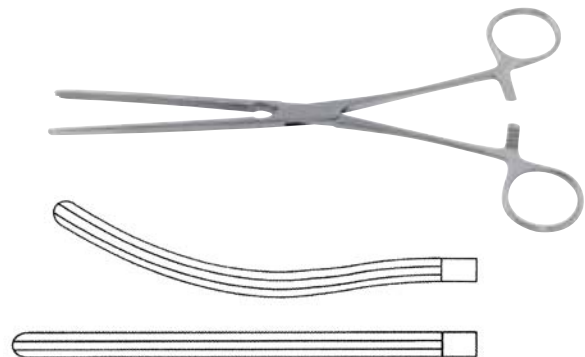



## MAYO-ROBSON INTESTINAL FORCEPS

Longitudinal serrations. Overall length 10" (25.4cm).

<u>Item Number</u>	<u>Description</u>
--------------------	--------------------

MDS6423025	Straight
------------	----------

MDS6423125	Curved
------------	--------



## DOYEN INTESTINAL FORCEPS

Diagonal serrations. Overall length 8<sup>3</sup>/<sub>4</sub>" (22.2cm).

<u>Item Number</u>	<u>Description</u>
--------------------	--------------------

MDS6421023	Straight
------------	----------

MDS6421123	Curved, flexible jaws
------------	-----------------------

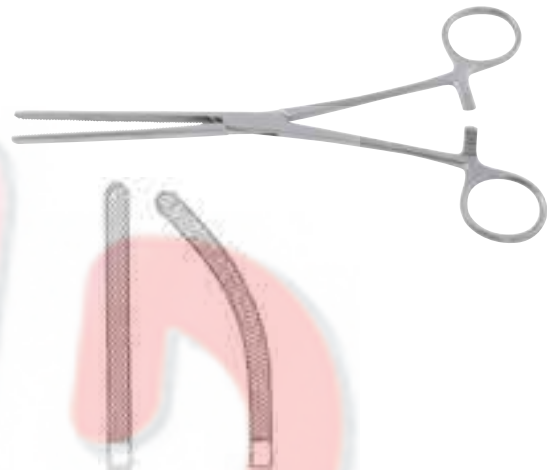

## GLASSMAN NON-CRUSHING GASTROINTESTINAL CLAMPS

<u>Item Number</u>	<u>Description</u>
--------------------	--------------------

MDS6420423	Straight, overall length 9 <sup>1</sup> / <sub>4</sub> " (23.5cm)
------------	--

MDS6420523	Angled, overall length 9" (22.9cm)
------------	---------------------------------------

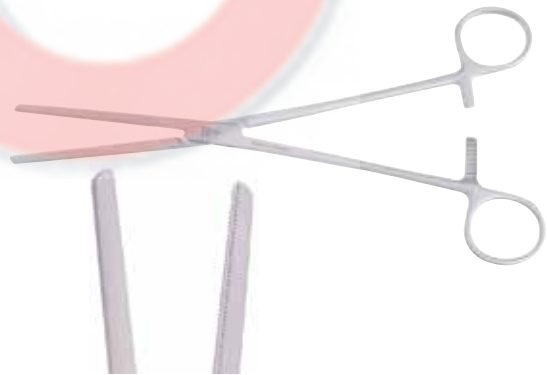

## GLASSMAN NON-CRUSHING INTESTINAL AND LIVER-HOLDING CLAMPS

Overall length 9<sup>3</sup>/<sub>4</sub>" (24.8cm).

<u>Item Number</u>	<u>Description</u>
--------------------	--------------------

MDS6420625	Straight
------------	----------

MDS6421625	Curved
------------	--------

MDS6424625	Fully curved
------------	--------------



## GLASSMAN ANTERIOR RESECTION CLAMPS

Jaws right-angled. Fully serrated.

Item Number	Description
MDS6421425	Jaw length 1" (2.5cm), overall length 9 <sup>3</sup> / <sub>4</sub> " (24.8cm)
MDS6422425	Jaw length 2" (5.1cm), overall length 9 <sup>3</sup> / <sub>4</sub> " (24.8cm)
MDS6423425	Jaw length 3" (7.6cm), overall length 10" (25cm)

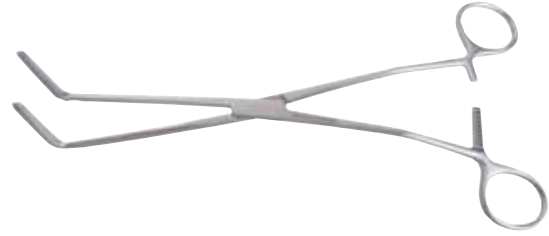

## GLASSMAN-ALLIS NON-CRUSHING INTESTINAL FORCEPS

Item Number	Description
MDS6412416	Overall length 6" (15.2cm)
MDS6412420	Overall length 6" (15.2cm)
MDS6412425	Fine, overall length 6" (15.2cm)
MDS6412430	Overall length 7 <sup>1</sup> / <sub>2</sub> " (19.1cm)

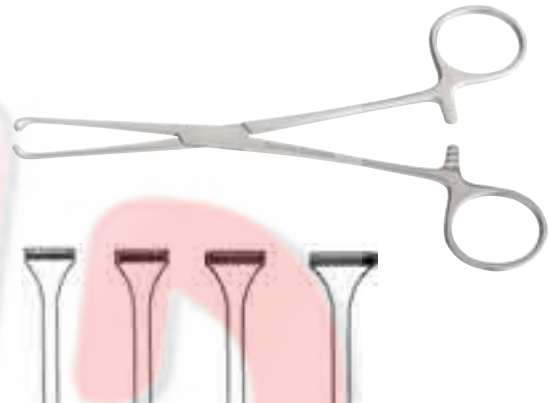

## GLASSMAN NON-CRUSHING GASTROENTEROSTOMY CLAMP

Item Number	Description
MDS6416726	Overall length 10 <sup>1</sup> / <sub>8</sub> " (25.7cm), angled, jaw length 4 <sup>1</sup> / <sub>2</sub> " (11.4cm).



## BEST RIGHT-ANGLE COLON CLAMPS

Overall length 11" (27.9cm).

Item Number	Description
MDS6413824	Jaw length 1 <sup>3</sup> / <sub>8</sub> " (3.5cm)
MDS6413826	Jaw length 2 <sup>3</sup> / <sub>8</sub> " (6cm)
MDS6413828	Jaw length 3" (7.6cm)



## RAVITCH PYLORIC STENOSIS SPREADER

Each blade has a small lip to reduce slippage.

<u>Item Number</u>	<u>Description</u>
MDS6424014	Overall length 5 <sup>3</sup> / <sub>4</sub> " (14.6cm)

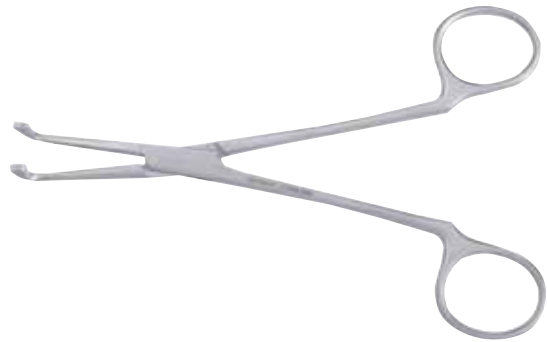

## LAHEY GOITER VULSELLUM FORCEPS

Straight. 3 x 3 teeth.

<u>Item Number</u>	<u>Description</u>
MDS5452015	Overall length 6" (15.2cm)

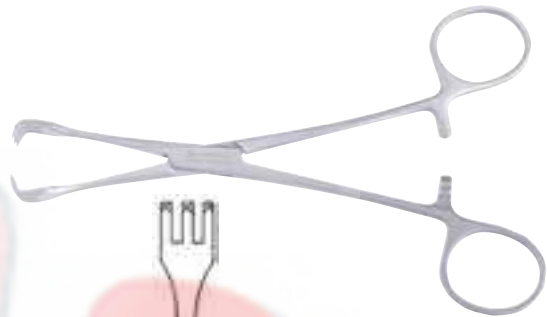

## MIXTER GALL DUCT FORCEPS

Fully curved.

<u>Item Number</u>	<u>Description</u>
MDS1247116	Overall length 6 <sup>1</sup> / <sub>4</sub> " (15.9cm)
MDS1247119	Overall length 7 <sup>3</sup> / <sub>4</sub> " (19.7cm)

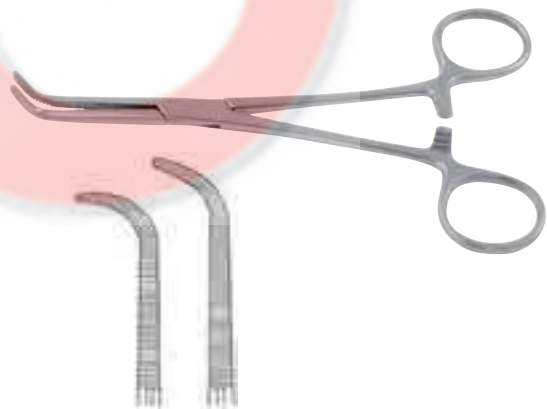

## THOREK-MIXTER GALL DUCT FORCEPS

Fully curved.

<u>Item Number</u>	<u>Description</u>
MDS1257514	Overall length 5 <sup>1</sup> / <sub>2</sub> " (14cm)



## GEMINI ARTERY FORCEPS

Fine "J" curve.

Item Number	Description
MDS1243113	Overall length 5½" (14cm)
MDS1243118	Overall length 7" (17.8cm)
MDS1243120	Overall length 8" (20.3cm)
MDS1243123	Overall length 9" (22.9cm)
MDS1243128	Overall length 11⅛" (28.3cm)



## MEEKER ARTERY FORCEPS

Right-angled jaws.

Item Number	Description
MDS1245918	Overall length 7" (17.8cm)
MDS1245928	Overall length 11" (27.9cm)

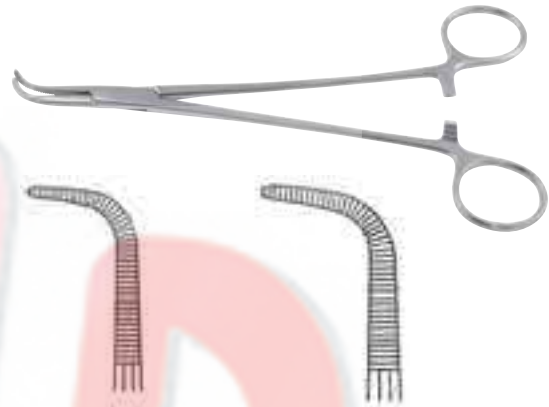

## LAHEY GALL DUCT FORCEPS

Item Number	Description
MDS1249119	Angled serrations, overall length 7½" (19.1cm)
MDS1249323	Angled serrations, overall length 9" (23cm)

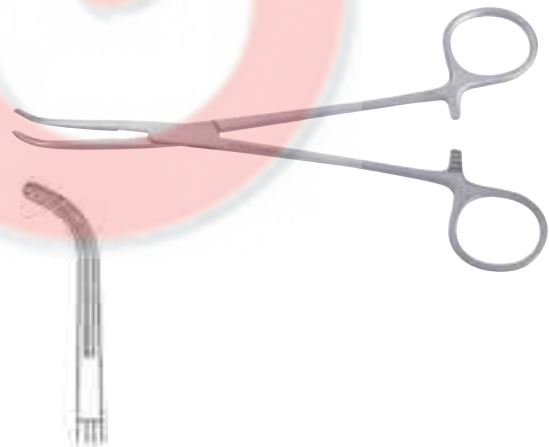

## LAHEY GALL DUCT FORCEPS

Item Number	Description
MDS1249120	Longitudinal serrations, overall length 7¾" (19.7cm)
MDS1245119	Right angle, longitudinal serrations with cross-serrated tips, overall length 7½" (19.1cm)

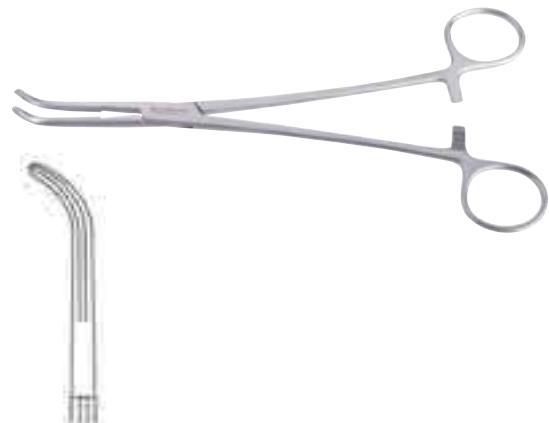

## SHALLCROSS CYSTIC DUCT FORCEPS

Fully curved.

<u>Item Number</u>	<u>Description</u>
MDS1259618	Overall length 8" (20.3cm)



## LOVELACE LUNG FORCEPS

Angled shanks. Jaws 1" (25mm) wide.

<u>Item Number</u>	<u>Description</u>
MDS5629120	Overall length 7 <sup>3</sup> / <sub>8</sub> " (18.7cm)



## GRAY CYSTIC DUCT FORCEPS

Set of two. Without teeth. Curved.

<u>Item Number</u>	<u>Description</u>
MDS1250723	Overall length 9" (22.9cm)

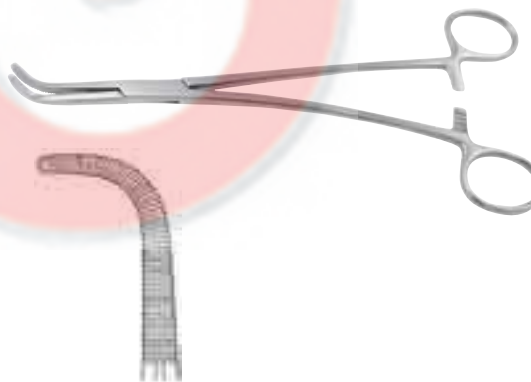

## RANDALL KIDNEY STONE FORCEPS

<u>Item Number</u>	<u>Description</u>
MDS6223101	Quarter curved, No. 1, overall length 9" (23cm)
MDS6223102	Half curved, No. 2, overall length 8 <sup>1</sup> / <sub>4</sub> " (21cm)
MDS6223103	Three-quarter curved, No. 3, overall length 8" (20.3cm)
MDS6223104	Fully curved, overall length 8" (20.3cm)

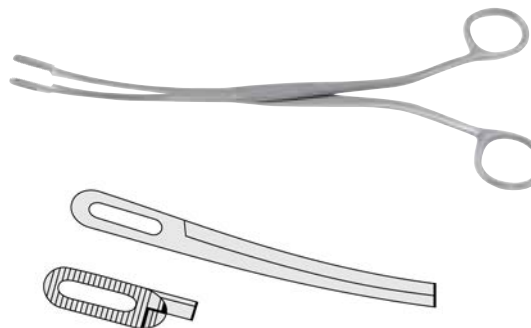



## ROCHESTER GALL STONE FORCEPS

Slight curve, fenestrated jaw, cupped. Screw lock.

<b>Item Number</b>	<b>Description</b>
MDS1250725	Overall length 9" (23cm)



## PROBES WITH EYE

Silver plated.

<b>Item Number</b>	<b>Description</b>
MDS2010214	Overall length 4½" (11.4cm)
MDS2010216	Overall length 5" (12.7cm)
MDS2010220	Overall length 5½" (14cm)
MDS2010225	Overall length 6" (15.2cm)
MDS2010230	Overall length 8" (20.3cm)
MDS2010211	Overall length 10" (25.4cm)
MDS2010213	Overall Length 12" (30.5cm)



## GROOVED DIRECTORS WITH TONGUE TIE

<b>Item Number</b>	<b>Description</b>
MDS2011011	Overall length 4½" (11.4cm)
MDS2011013	Overall length 5" (12.7cm)
MDS2011014	Overall length 5½" (14cm)
MDS2011016	Overall length 6" (15.2cm)



## GROOVED DIRECTORS WITH PROBE END AND TONGUE TIE

<b>Item Number</b>	<b>Description</b>
MDS2011211	Overall length 4½" (11.4cm)
MDS2011213	Overall length 5" (12.7cm)
MDS2011214	Overall length 5½" (14cm)
MDS2011216	Overall length 6" (15.2cm)



## BAKES COMMON BILE DUCT DILATORS

Overall length 9" (22.9cm).

Item Number	Description
MDS6215000	Set includes 9 dilators
MDS6215003	3mm
MDS6215004	4mm
MDS6215005	5mm
MDS6215006	6mm
MDS6215007	7mm
MDS6215008	8mm
MDS6215009	9mm
MDS6215010	10mm
MDS6215011	11mm

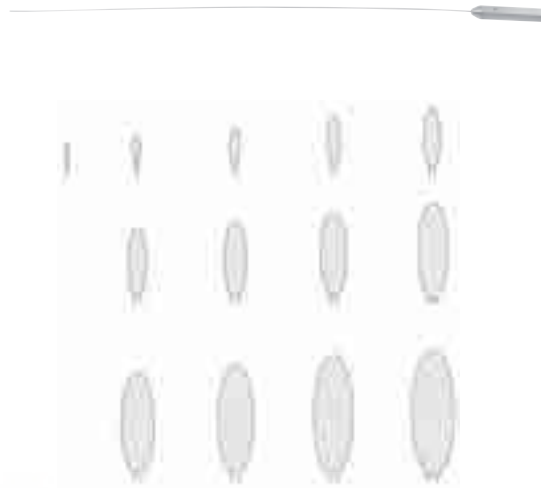

## MAYO COMMON DUCT SCOOPS

Malleable. Silver plated. Overall length 11" (27.9cm).

Item Number	Description
MDS6217801	No. 1, small
MDS6217802	No. 2, medium
MDS6217803	No. 3, large



## MEYERDING FINGER RETRACTORS

Overall length 7" (17.8cm).

Item Number	Description
MDS1830201	Style A, long blunt blade, $\frac{1}{4}$ " x $\frac{11}{16}$ " (6mm x 17mm)
MDS1830202	Style B, long toothed blade, $\frac{3}{16}$ " x $\frac{5}{8}$ " (5mm x 16mm)
MDS1830203	Style C, short toothed blade, $\frac{1}{8}$ " x $\frac{1}{4}$ " (3mm x 6mm)
MDS1830205	Style D, short blunt blade, $\frac{1}{8}$ " x $\frac{3}{8}$ " (3mm x 10mm)
MDS1830204	Style E, curved blunt blade, $\frac{1}{8}$ " x $\frac{3}{8}$ " (3mm x 10mm)
MDS1830206	Style F, curved, three-pronged sharp blade, $\frac{3}{8}$ " x $\frac{5}{32}$ " (10mm x 4mm)

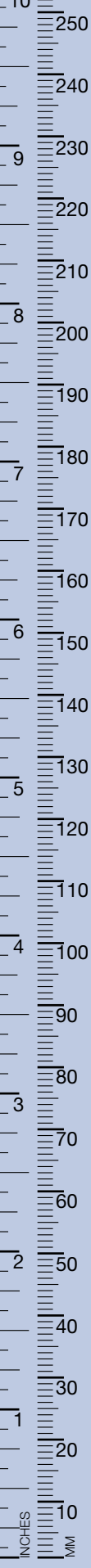
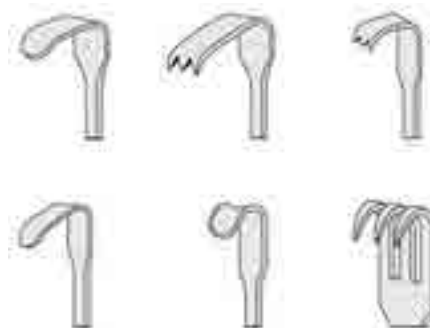

## SENN RETRACTORS

Fine, double-ended. Overall length 6<sup>1</sup>/<sub>4</sub>" (15.9cm).

<u>Item Number</u>	<u>Description</u>
MDS1816215	Sharp
MDS1816315	Blunt



## GREEN GOITER RETRACTOR

Fully curved wire loop blade.

<u>Item Number</u>	<u>Description</u>
MDS1834822	Overall length 8 <sup>3</sup> / <sub>4</sub> " (22.2cm)



## LAHEY GOITER RETRACTOR

Right angle blade, length 1" (2.5cm). With lip.

<u>Item Number</u>	<u>Description</u>
MDS1830419	Overall length 8" (20.3cm)

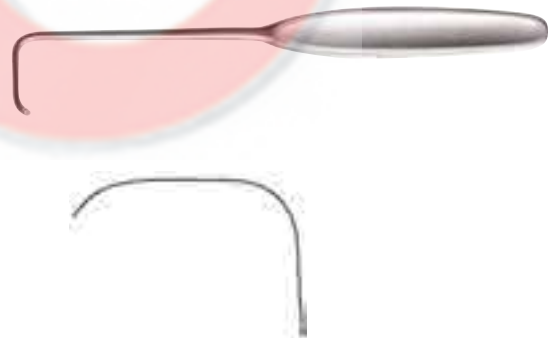

## MCBURNEY THYROID RETRACTOR

Blade <sup>3</sup>/<sub>4</sub>" x <sup>3</sup>/<sub>8</sub>" (1.9cm x 1cm).

<u>Item Number</u>	<u>Description</u>
MDS1831719	Overall length 7 <sup>3</sup> / <sub>8</sub> " (18.7cm)



## LANGENBECK RETRACTOR

<u>Item Number</u>	<u>Description</u>
MDS1831004	Blade $1\frac{5}{8}$ " x $\frac{1}{2}$ " (4.1cm x 1.27cm), overall length $8\frac{1}{2}$ " (21.6cm)



## PARKER RETRACTORS

Double-ended. Set of two.

<u>Item Number</u>	<u>Description</u>
MDS1811013	Overall length 5" (13cm)
MDS1811018	Overall length 7" (18cm)



## MAYO-COLLINS RETRACTORS

Double-ended. Set of two.

<u>Item Number</u>	<u>Description</u>
MDS1811215	Overall length $5\frac{7}{8}$ " (14.9cm)



## ROUX RETRACTORS

Double-ended. Overall length  $7\frac{1}{2}$ " (19.1cm).

<u>Item Number</u>	<u>Description</u>
MDS1812014	Blades $\frac{7}{8}$ " (2.2cm) and $1\frac{1}{2}$ " (3.8cm) wide
MDS1812017	Blades $1\frac{3}{8}$ " (3.5cm) and $1\frac{7}{8}$ " (4.8cm) wide

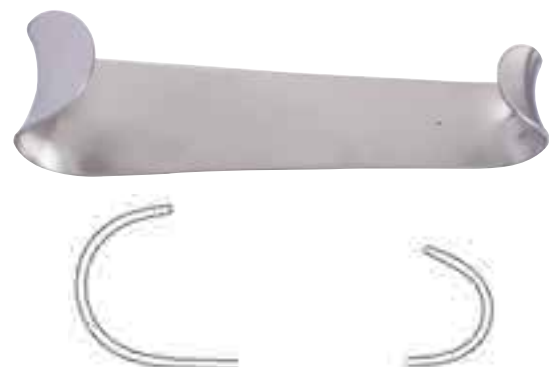

## GOELET RETRACTOR

Double-ended. Overall length 7¼" (18.4cm).

<u>Item Number</u>	<u>Description</u>
MDS1813519	Blades 1¾" (4.4cm) and 1½" (3.8cm) wide

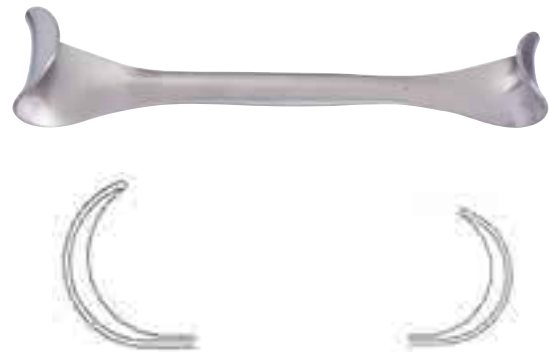

## SEEBURGER RETRACTOR

<u>Item Number</u>	<u>Description</u>
MDS1877514	Pair, overall length 5½" (14cm)



## U.S.A. RETRACTORS

Double-ended. Set of two.

<u>Item Number</u>	<u>Description</u>
MDS1813121	Overall length 8¼" (21cm)

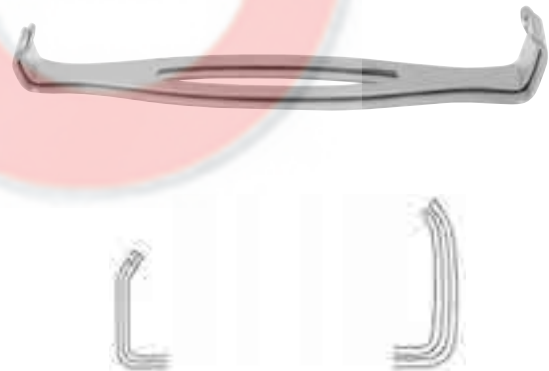

## CUSHING RETRACTOR

Straight. Plain edge.

<u>Item Number</u>	<u>Description</u>
MDS1823421	Overall length 8¾" (22.2cm)





## VEIN RETRACTORS

<u>Item Number</u>	<u>Description</u>
MDS1823510	Blade 11mm wide, overall length 9 <sup>1</sup> / <sub>4</sub> " (23.5cm)
MDS1823514	Blade 15mm wide, overall length 9 <sup>1</sup> / <sub>2</sub> " (24.1cm)



## CUSHING VEIN RETRACTORS

<u>Item Number</u>	<u>Description</u>
MDS1823430	Overall length 12 <sup>1</sup> / <sub>2</sub> " (31.8cm)
MDS1823435	Overall length 14" (35.6cm)
MDS1823440	Overall length 16" (40.6cm)



## CRILE RETRACTORS

Double-ended.

<u>Item Number</u>	<u>Description</u>
MDS1812711	No.1, blades <sup>1</sup> / <sub>8</sub> " x <sup>7</sup> / <sub>16</sub> " (3mm x 11mm) and <sup>1</sup> / <sub>4</sub> " x <sup>13</sup> / <sub>16</sub> " (6mm x 21mm), overall length 4 <sup>1</sup> / <sub>4</sub> " (10.8cm)



## LITTLE RETRACTOR

Blade <sup>5</sup>/<sub>8</sub>" x <sup>7</sup>/<sub>16</sub>" (16mm x 11mm).

<u>Item Number</u>	<u>Description</u>
MDS1830620	Overall length 7 <sup>3</sup> / <sub>8</sub> " (18.7cm)



## VOLKMANN RETRACTORS

Long pattern. Overall length 8<sup>3</sup>/<sub>4</sub>" (22.2cm).

<b>Item Number</b>	<b>Description</b>
MDS1828101	Blunt, one prong
MDS1828102	Blunt, two prongs
MDS1828103	Blunt, three prongs
MDS1828104	Blunt, four prongs
MDS1828105	Blunt, five prongs
MDS1828106	Blunt, six prongs
MDS1828001	Sharp, one prong
MDS1828002	Sharp, two prongs
MDS1828003	Sharp, three prongs
MDS1828004	Sharp, four prongs
MDS1828005	Sharp, five prongs
MDS1828006	Sharp, six prongs



## MURPHY RETRACTORS

Rakes are same size as Volkmann retractors. Overall length 7<sup>1</sup>/<sub>2</sub>" (19.1cm).

<b>Item Number</b>	<b>Description</b>
MDS1826003	Sharp, three prongs
MDS1826103	Blunt, three prongs
MDS1826004	Sharp, four prongs
MDS1826104	Blunt, four prongs
MDS1826106	Blunt, six prongs



## FINGER VOLKMANN RETRACTORS

Overall length 4<sup>1</sup>/<sub>2</sub>" (11cm).

<b>Item Number</b>	<b>Description</b>
MDS1838002	Blunt, two prong
MDS1838003	Blunt, three prong
MDS1838004	Blunt, four prong
MDS1838006	Blunt, six prong
MDS1838102	Sharp, two prong
MDS1838103	Sharp, three prong
MDS1838104	Sharp, four prong
MDS1838106	Sharp, six prong



## ISRAEL RETRACTORS

Blunt. Overall length 9 1/2" (24.1cm).

Item Number	Description
MDS1836440	Four prongs, 40 x 40mm
MDS1836450	Five prongs, 45 x 50mm
MDS1836460	Six prongs, 50 x 60mm
MDS1836470	Six prongs, 70 x 70mm



## RICHARDSON RETRACTORS

Item Number	Description
MDS1815001	Blade 1" x 3/4" (2.5cm x 1.9cm) wide, overall length 9 1/4" (23.5cm)
MDS1815002	Blade 1 1/4" x 1 1/8" (3.2cm x 2.9cm) wide, overall length 9 1/4" (23.5cm)
MDS1815005	Blade 1 1/2" x 1 1/2" (3.8cm x 3.8cm) wide, overall length 9 1/2" (25.4cm)
MDS1815003	Blade 1 1/2" x 1 1/2" (3.8cm x 3.8cm) wide, overall length 10" (25.4cm)
MDS1815626	Blade 2 1/2" x 1 5/8" (6.4cm x 4.1cm) wide, overall length 10" (25.4cm)
MDS1815004	Blade 2" x 3/4" (5.1cm x 1.9cm) wide, overall length 9 1/4" (23.5cm)
MDS1815251	Grip Handle, blade 2" x 3/4" (5.1cm x 1.9cm)



## C. W. MAYO ABDOMINAL RETRACTORS

Angled blade.

Item Number	Description
MDS1813207	Blade 2 3/4" (7cm) wide, overall length 10 1/8" (25.7cm)
MDS1813208	Blade 3 1/8" (7.9cm) wide, overall length 9 3/4" (24.8cm)



## KELLY RETRACTORS

<b>Item Number</b>	<b>Description</b>
MDS1815638	Blade 2" x 1½" (5.1cm x 3.8cm) wide, overall length 10½" (26.7cm)
MDS1815851	Blade 2" x 1½" (5.1cm x 3.8cm) wide, grip handle, overall length 10½" (26.7cm)
MDS1815864	Blade 2½" x 2" (6.4cm x 5.1cm) wide, overall length 10½" (26.7cm)
MDS1815630	Blade 3" x 2½" (7.6cm x 6.4cm) wide, overall length 11" (27.9cm)
MDS1815882	Blade 3½" x 3" (8.9cm x 7.6cm) wide, overall length 11¼" (28.6cm).



## RICHARDSON-EASTMAN RETRACTORS

Double-ended.

<b>Item Number</b>	<b>Description</b>
MDS1814000	Set of two, small and large
MDS1814001	Small, blade 1⅛" x ¾" (2.9cm x 1.9cm) wide and 1½" x 1⅛" (3.8cm x 2.9cm) wide, overall length 10" (25.4cm)
MDS1814002	Large, blade ¾" x 1½" (4.4cm x 3.8cm) wide and 2½" x 1⅝" (6.4cm x 4.1cm) wide, overall length 10¼" (26cm)

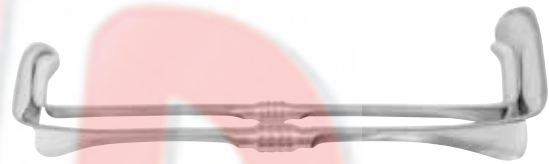

## WYLIE RENAL VEIN RETRACTORS

<b>Item Number</b>	<b>Description</b>
MDS0173286	Short, blade 4" x 1" (10cm x 2.5cm) wide, overall length 12¼" (31.2cm)
MDS0151199	Long, blade 7" x 1" (17.7cm x 2.5cm) wide, overall length 12½" (31.5cm)



## WEINBERG VAGOTOMY RETRACTOR (JOE'S HOE)

<b>Item Number</b>	<b>Description</b>
MDS1814016	Blade 4" x 6½" (10.2cm x 16.5cm) wide



## ST. MARKS PELVIS RETRACTOR

<u>Item Number</u>	<u>Description</u>
MDS1852301	11½" angled tip
MDS1852302	13⅛" angled tip
MDS1852303	13⅛" straight tip 3" from flat part



## HARRINGTON SPLANCHNIC RETRACTORS

Flat, deeply curved, springy blade with thickened distal end.  
Overall length 12½" (31.7cm).

<u>Item Number</u>	<u>Description</u>
MDS1819140	Blade 5" x 1½" (12.7cm x 3.8cm) wide
MDS1819162	Blade 5" x 2½" (12.7cm x 6.4cm) wide



## HARRINGTON-PEMBERTON RETRACTOR

Blade 7½" x 2½" (19.1cm x 6.4cm) wide,  
thickened distal end.

<u>Item Number</u>	<u>Description</u>
MDS1819164	Overall length 14½" (36.8cm)



## HARRINGTON RETRACTORS

Overall length 14½" (36.8cm).

<u>Item Number</u>	<u>Description</u>
MDS1819191	Large blade 7½" x 4½" (19.1cm x 11.4cm) wide
MDS1819192	Extra-large blade 7½" x 6½" (19.1cm x 16.5cm) wide



## B. E. GLASS ABDOMINAL RETRACTOR

Item Number	Description
MDS1817125	Blade 6" x 3 <sup>1</sup> / <sub>4</sub> " (15.5cm x 8.3cm) wide, overall length 9 <sup>3</sup> / <sub>4</sub> " (24.5cm)



## DAVIS BRAIN RETRACTORS

Flexible Silver. Overall length 7<sup>1</sup>/<sub>2</sub>" (19.1cm).

Item Number	Description
MDS1816812	1/2" (1.3cm) wide
MDS1816817	5/8" (1.6cm) wide
MDS1816819	3/4" (1.9cm) wide



## DAVIS-TYPE BRAIN RETRACTORS

Overall length 7" (17.8cm).

Item Number	Description
MDS4025106	1/4" (6mm) wide
MDS4025110	3/8" (10mm) wide
MDS4025114	1/2" (13mm) wide
MDS4025116	5/8" (16mm) wide
MDS4025125	1" (25mm) wide



## FLEXSTEEL RIBBON RETRACTORS

Item Number	Description
MDS1817017	Blade 2/3" (1.7cm) wide, overall length 13" (33cm)
MDS1817018	Blade 3/4" (1.9cm) wide, overall length 13" (33cm)
MDS1817025	Blade 1" (2.5cm) wide, overall length 13" (33cm)
MDS1817032	Blade 1 1/4" (3.2cm) wide, overall length 13" (33cm)
MDS1817040	Blade 1 1/2" (3.8cm) wide, overall length 13" (33cm)
MDS1817050	Blade 2" (5.1cm) wide, overall length 13" (33cm)
MDS1817063	Blade 2 1/2" (6.3cm) wide, overall length 13" (33cm)
MDS1817075	Blade 3" (7.6cm) wide, overall length 13" (33cm)
MDS1816825	Blade 1" (2.5cm) wide, overall length 10" (25.4cm)





## SILICONE-COATED BRAIN RETRACTORS

Malleable. Round edges with extra silicone at the tip.  
Not recommended for use with lasers. Steam sterilization is recommended. Overall length 6<sup>7</sup>/<sub>8</sub>" (17.5cm).

<b>Item Number</b>	<b>Description</b>
MDS1131006	Small, width tapers from 6mm to 10mm wide
MDS1131009	Medium, width tapers from 9mm to 15mm wide
MDS1131011	Large, width tapers from 11mm to 20mm wide
MDS1131013	Extra-large, width tapers from 14mm to 25mm wide



## DEAVER RETRACTORS

<b>Item Number</b>	<b>Description</b>
MDS1818125	Blade 1" (2.5cm) wide, overall length 9" (22.9cm)
MDS1818225	Blade 1" (2.5cm) wide, overall length 10" (25.4cm)
MDS1818525	Blade 1" (2.5cm) wide, overall length 13" (33cm)
MDS1818325	Blade 1" (2.5cm) wide, overall length 12" (30.5cm)
MDS1818738	Blade 1 <sup>1</sup> / <sub>2</sub> " (3.8cm) wide, overall length 12" (30.5cm)
MDS1818750	Blade 2" (5.1cm) wide, overall length 13" (33cm)
MDS1818019	Blade <sup>3</sup> / <sub>4</sub> " (1.9cm) wide, overall length 6 <sup>1</sup> / <sub>2</sub> " (16.5cm)
MDS1818122	Blade <sup>3</sup> / <sub>4</sub> " (1.9cm) wide, overall length 8 <sup>1</sup> / <sub>2</sub> " (21.6cm)
MDS1818775	Blade 3" (7.6cm) wide, overall length 12" (30.5cm)



## WALTER-DEAVER RETRACTORS

Hollow handle.

Item Number	Description
MDS1819025	Blade 1" (2.5cm) wide, overall length 13" (33cm)
MDS1818925	Blade 1" (2.5cm) wide, overall length 12" (30.5cm)
MDS1818938	Blade 1½" (3.8cm) wide, overall length 12" (30.5cm)
MDS1818950	Blade 2" (5.1cm) wide, overall length 12" (30.5cm)



## SPRING WIRE RETRACTORS

Item Number	Description
MDS1850001	Size 1, small prongs, overall length 5" (12.7cm)
MDS1850002	Size 2, medium prongs, overall length 5⅛" (13cm)
MDS1850003	Size 3, large prongs, overall length 9" (22.9cm)



## SPRING WIRE RETRACTORS

Item Number	Description
MDS1860001	Size 1, 1 x 1 prongs, overall length 3" (7.6cm)
MDS1860002	Size 2, 3 x 3 prongs, overall length 3½" (8.9cm)
MDS1860003	Size 3, 3 x 3 prongs, overall length 4½" (11.4cm)

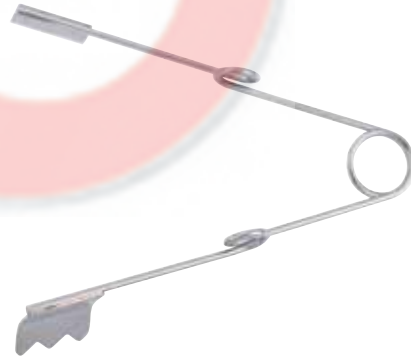

## FARR SPRING RETRACTOR

Sharp.

Item Number	Description
MDS1860105	Overall length 1½" (3.8cm)
MDS1860106	Overall length 2" (5.1cm)
MDS1860107	Overall length 2¼" (5.7cm)
MDS1860108	Overall length 2½" (6.4cm)
MDS1860109	Overall length 3" (7.6cm)
MDS1860102	Overall length 5½" (14cm)

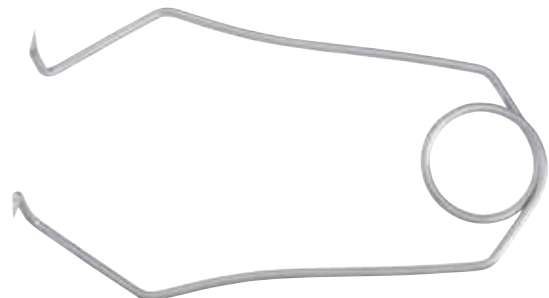

## AUTOMATIC SKIN RETRACTORS

Cross-action, with ratchet lock. 4 x 4 prongs.  
Overall length 4" (10.2cm).

Item Number	Description
MDS1863410	Sharp prongs
MDS1863510	Blunt prongs



## ALM MINOR SURGERY RETRACTORS

4 x 4 blunt prongs.

Item Number	Description
MDS1862107	Total opening 2" (5.1cm), overall length 2 <sup>3</sup> / <sub>4</sub> " (7cm)
MDS1862110	Total opening 2 <sup>1</sup> / <sub>4</sub> " (5.7cm), overall length 3" (7.6cm)



## GOSSET RETRACTOR

Self-retaining. Wire blades. Depth 1<sup>1</sup>/<sub>4</sub>" (3.2cm).

Item Number	Description
MDS1876110	Operative opening 4" (10.2cm)

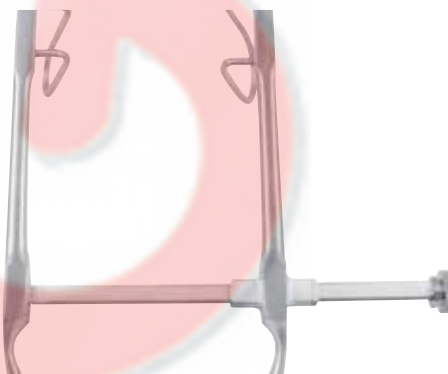

## GELPI PERINEAL RETRACTORS

Self-retaining. Sharp tenaculum prongs.

Item Number	Description
MDS1880218	Total opening 3 <sup>1</sup> / <sub>4</sub> " (8.3cm), arm length 4 <sup>3</sup> / <sub>4</sub> " (12.1cm), overall length 7 <sup>1</sup> / <sub>4</sub> " (18.4cm)
MDS1880214	Total opening 2 <sup>1</sup> / <sub>8</sub> " (5.4cm), arm length 3" (7.6cm), overall length 5 <sup>1</sup> / <sub>4</sub> " (13.3cm)
MDS1880211	Total opening 1 <sup>5</sup> / <sub>8</sub> " (4.1cm), arm length 2" (5cm), overall length 4 <sup>1</sup> / <sub>2</sub> " (11.4cm)
MDS1880209	Total opening 1 <sup>3</sup> / <sub>8</sub> " (3.5cm), arm length 1 <sup>1</sup> / <sub>4</sub> " (3.2cm), overall length 3 <sup>1</sup> / <sub>2</sub> " (8.9cm)



## GELPI PERINEAL RETRACTOR

Self-retaining. Balls stops on sharp tenaculum prongs.

Item Number	Description
MDS1880418	Total opening 3 <sup>1</sup> / <sub>4</sub> " (8.3cm), arm length 4 <sup>3</sup> / <sub>4</sub> " (12.1cm), overall length 7" (17.8cm)



## WILTSE GELPI RETRACTOR

Self-retaining. Sharp tenaculum prongs.

Item Number	Description
MDS1880427	Total opening 5" (12.7cm), arm length 7 <sup>1</sup> / <sub>2</sub> " (19cm), 2 <sup>3</sup> / <sub>4</sub> " (7cm) deep hooks, overall length 11" (27.9cm)



## BABY WEITLANER RETRACTORS

Self-retaining. 2 x 3 prongs. Total opening 2<sup>1</sup>/<sub>4</sub>" (5.7cm). Overall length 4<sup>1</sup>/<sub>4</sub>" (10.8cm).

Item Number	Description
MDS1865110	Blunt prongs
MDS1865010	Sharp prongs



## WEITLANER RETRACTORS

3 x 4 prongs.

<u>Item Number</u>	<u>Description</u>
MDS1867013	Sharp prongs, overall length 5½" (14cm)
MDS1867016	Sharp prongs, overall length 6½" (16.5cm)
MDS1867020	Sharp prongs, overall length 8" (20.3cm)
MDS1867025	Sharp prongs, overall length 9½" (24.1cm)
MDS1867113	Blunt prongs overall length 5½" (14cm)
MDS1867116	Blunt prongs, overall length 6½" (16.5cm)
MDS1867120	Blunt prongs, overall length 8" (20.3cm)
MDS1867125	Blunt prongs, overall length 9½" (24.1cm)



## BECKMAN RETRACTOR

Hinged arms, 3 x 4 sharp prongs.

<u>Item Number</u>	<u>Description</u>
MDS1800416	Overall length 6¾" (17.1cm)

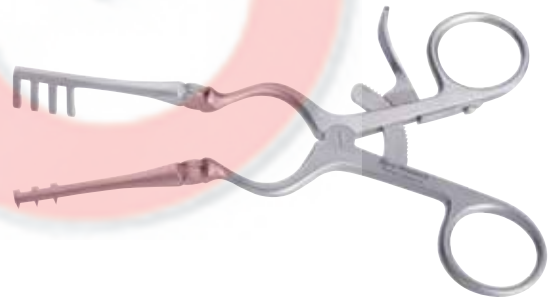

## BECKMAN GOITER RETRACTOR

4 x 4 sharp prongs.

<u>Item Number</u>	<u>Description</u>
MDS1869031	Overall length 12" (30.5cm)

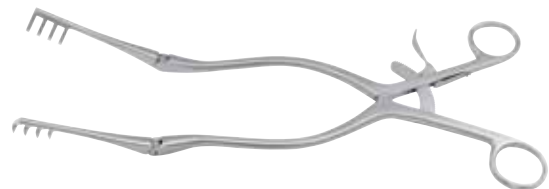

## O'SULLIVAN-O'CONNOR ABDOMINAL RETRACTOR

Item Number	Description
MDS1875400	Includes 3 center blades, 2 blades 1 <sup>3</sup> / <sub>4</sub> " (4.4cm) wide, and 1 blade, 2 <sup>3</sup> / <sub>4</sub> " (7cm) wide, and 2 mounted side blades, 2 <sup>3</sup> / <sub>4</sub> " (7cm) deep



## BALFOUR ABDOMINAL RETRACTOR

Includes one 3" (7.6cm) wide and 3<sup>1</sup>/<sub>8</sub>" (7.9cm) wide center blades and two 2<sup>1</sup>/<sub>2</sub>" (6.4cm) deep and 3<sup>1</sup>/<sub>2</sub>" (8.9cm) deep wire side blades. Operative opening 9<sup>1</sup>/<sub>4</sub>" (23.5cm).

Item Number	Description
MDS1891800	Overall width 12" (30.5cm)



## BALFOUR PEDIATRIC ABDOMINAL RETRACTOR

Includes one 1" (2.5cm) wide center blade and two 1" (2.5cm) deep wire side blades. Operative opening 3<sup>1</sup>/<sub>2</sub>" (8.9cm).

Item Number	Description
MDS1876690	Overall width 5 <sup>3</sup> / <sub>8</sub> " (13.7cm)

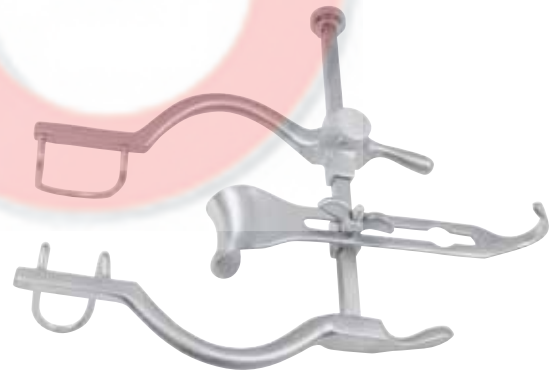

## BALFOUR RETRACTORS

Includes one 3" (7.6cm) wide center blade, two 2<sup>1</sup>/<sub>2</sub>" (6.4cm) deep and two 3<sup>1</sup>/<sub>2</sub>" (8.9cm) deep wire side blades.

Item Number	Description
MDS1891810	Operative opening 8 <sup>1</sup> / <sub>2</sub> " (21.6cm), overall width 10" (27cm)
MDS1891813	Operative opening 10 <sup>1</sup> / <sub>2</sub> " (26.7cm), overall width 13" (33cm)





## BALFOUR RETRACTOR DEEP MODEL

Includes one 3" (7.6cm) wide solid center blade and two 3<sup>1</sup>/<sub>4</sub>" (8.3cm) deep wire side blades. Operative opening 9<sup>1</sup>/<sub>4</sub>" (23.5cm).

<u>Item Number</u>	<u>Description</u>
MDS1876425	Overall width 12" (30.5cm)



## BALFOUR SIDE BLADES

For MDS1891810 and MDS1891813. Pair.

<u>Item Number</u>	<u>Description</u>
MDS1898306	Wire, 2 <sup>1</sup> / <sub>2</sub> " (6.4cm) deep
MDS1898310	Wire, 4" (10.2cm) deep



## BALFOUR CENTER BLADES

<u>Item Number</u>	<u>Description</u>
MDS1876570	Small, 2 <sup>5</sup> / <sub>8</sub> " (6.7cm) wide
MDS1876578	Medium, 3" (7.6cm) wide
MDS1876579	Large, 3 <sup>1</sup> / <sub>8</sub> " (7.9cm) wide



## DIXON CENTER BLADES

Malleable.

<u>Item Number</u>	<u>Description</u>
MDS1886517	7 <sup>3</sup> / <sub>4</sub> " x 2" (19.7cm x 5cm) wide



## HORGAN CENTER BLADE

<b>Item Number</b>	<b>Description</b>
MDS1886512	5" x 2 $\frac{1}{8}$ " (12.7cm x 5.4cm) wide



## FOURTH BLADE EXTENSIONS

Extension arm for Balfour retractor. Recommended for use with MDS1891810 and MDS1891813. Blade not included.

<b>Item Number</b>	<b>Description</b>
MDS188651R	For right arm
MDS188651L	For left arm



## ROUND RING

<b>Item Number</b>	<b>Description</b>
MDS2262096	Small, inside diameter 8 $\frac{1}{2}$ " (21.6cm)
MDS2262094	Medium, inside diameter 10 $\frac{1}{2}$ " (26.7cm)
MDS2262095	Large, inside diameter 12 $\frac{1}{2}$ " (31.8cm)

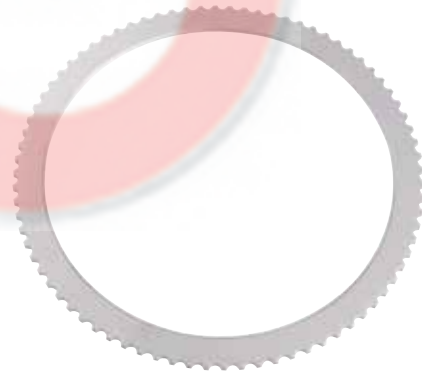

## OVAL RINGS

<b>Item Number</b>	<b>Description</b>
MDS2262091	Small, inside dimensions 8 $\frac{1}{2}$ " x 12" (21.6cm x 30.5cm)
MDS2262092	Medium, 10 $\frac{1}{2}$ " x 15" (26.7cm x 38.1cm)
MDS2262093	Large, inside dimension 12 $\frac{1}{2}$ " x 18 $\frac{1}{2}$ " (31.8cm x 47cm)



## SEGMENTED OVAL RING

Original-style.

<u>Item Number</u>	<u>Description</u>
MDS2262016	Small, inside dimension 8½" x 14" (21.6cm x 35.6cm), includes two - 4" (10.2cm) straight ring segments
MDS2262017	Medium, inside dimension 10½" x 19½" (26.6cm x 49.5cm), includes two - 8" (20.3cm) straight ring segments
MDS2262018	Large, inside dimension 12½" x 19½" (31.7cm x 49.5cm), includes two - 6" (15.2cm) straight ring segments



## NON-TILTING BLADE CLAMP

### Item Number

MDS2262959



## ADVANCED TILTING RATCHET MECHANISM

### Item Number

MDS2262954



## POST COUPLING CLAMP

### Item Number

MDS1186245 For 1" bar



## HORIZONTAL FLEX BAR

### Item Number

MDS2284137



## HORIZONTAL SOLID BAR

### Item Number

MDS2262905

### Description

Overall length 15½" (39.4cm)



## EXTENSION BAR

### Item Number

MDS2284141

### Description

Bar diameter 1",  
overall length 13½" (34.3cm)



## TABLE CLAMP

With vertical post.

### Item Number

MDS2284113

### Description

Overall length 17½" (44.5cm)



## BALFOUR BLADDER BLADES

<u>Item Number</u>	<u>Description</u>
MDS2262319	2 $\frac{1}{2}$ " x 3" (6.4cm x 7.6cm)
MDS2262320	3 $\frac{1}{4}$ " x 3" (8.3cm x 7.6cm)



## HARRINGTON BLADES

<u>Item Number</u>	<u>Description</u>
MDS2262342	5" x 2 $\frac{1}{2}$ " (12.7cm x 6.4cm)



## KELLY RETRACTOR BLADES

<u>Item Number</u>	<u>Description</u>
MDS2262300	1" x 1 $\frac{1}{4}$ " (2.5cm x 3.2cm)
MDS2262301	1" x 2 $\frac{1}{2}$ " (2.5cm x 6.4cm)
MDS2262299	2" x 1 $\frac{1}{2}$ " (5.1cm x 3.8cm)
MDS2262298	2" x 2 $\frac{1}{2}$ " (5.1cm x 6.4cm)
MDS2262294	2" x 3" (5.1cm x 7.6cm)
MDS2262297	2" x 4" (5.1cm x 10.2cm)
MDS2262200	2" x 5" (5.1cm x 12.7cm)
MDS2262203	2" x 6" (5.1cm x 15.2cm)

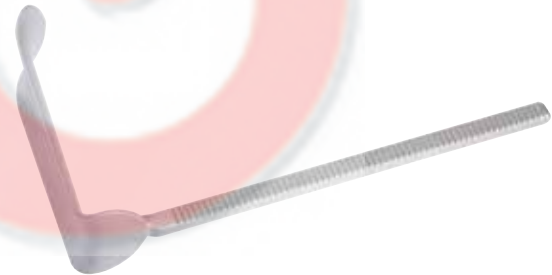

## MALLEABLE BLADES

<u>Item Number</u>	<u>Description</u>
MDS2262118	1 $\frac{1}{2}$ " x 6" (3.8cm x 15.2cm)
MDS2262139	2" x 6" (5.1cm x 15.2cm)
MDS2262142	3" x 6" (7.6cm x 15.2cm)



## GELPI RETRACTOR BLADE

### Item Number

MDS2262256



## DEAVER RETRACTOR BLADES

### Item Number Description

MDS2262284	Blade 4½" x 1" (11.4cm x 2.5cm)
MDS2262285	Blade 4½" x 1½" (11.4cm x 3.8cm)
MDS2262286	Blade 4½" x 2" (11.4cm x 5.1cm)



## POOLE ABDOMINAL SUCTION TUBES

### Item Number Description

MDS0414008	23Fr with curved tubing connection, overall length 8¼" (21cm)
MDS0413010	30Fr straight, overall length 9½" (24cm)
MDS0414012	30Fr straight, overall length 12" (30.5cm)
MDS0414014	30Fr straight, overall length 14" (35.6cm)
MDS0414016	30Fr straight, overall length 16" (40.6cm)
MDS0414018	30Fr straight, overall length 18" (45.7cm)

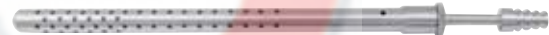

## FRAZIER SUCTION TUBES

Angled, with finger valve and obturator.

### Item Number Description

MDS4029506	6Fr, working length 3⅞" (9.8cm)
MDS4029507	7Fr, working length 3⅞" (9.8cm)
MDS4029508	8Fr, working length 3⅞" (9.8cm)
MDS4029509	9Fr, working length 3⅞" (9.8cm)
MDS4029510	10Fr, working length 3⅞" (9.8cm)
MDS4029511	11Fr, working length 3⅞" (9.8cm)
MDS4029512	12Fr, working length 3⅞" (9.8cm)





## FRAZIER SUCTION TUBE OBTURATORS

Item	number	Description
MDS4029516		For 6Fr tube MDS4029506
MDS4029517		For 7Fr tube MDS4029507
MDS4029518		For 8Fr tube MDS4029508
MDS4029519		For 9Fr tube MDS4029509
MDS4029520		For 10Fr tube MDS4029510
MDS4029531		For 11Fr tube MDS4029511
MDS4029522		For 12Fr tube MDS4029512



## ANDREWS-PYNCHON SUCTION TUBE

Smaller modification of the Pynchon tube. Mirror finish.

Item Number	Description
MDS0415222	Overall length 8 <sup>5</sup> / <sub>8</sub> " (22cm)



## YANKAUER SUCTION TUBES

Half-curved, with additional slight curved near the tip. Large, light, hollow handle.

Item Number	Description
MDS0415027	Overall length 10 <sup>3</sup> / <sub>4</sub> " (27.3cm), mirror finish
MDS0415030	Overall length 12" (30.5cm)
MDS0415035	Overall length 14" (35.6cm)
MDS0415040	Overall length 16" (40.6cm)
MDS0415045	Overall length 18" (45.7cm)

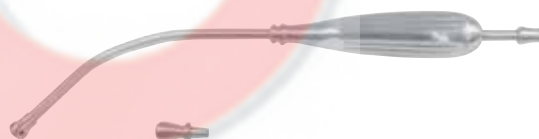

## FRAZIER SUCTION TUBES (MALIS-TYPE)

Angled 90°. Working length 7<sup>1</sup>/<sub>2</sub>" (19.1cm).

Item Number	Description
MDS4029707	7Fr
MDS4029709	9Fr
MDS4029711	11Fr

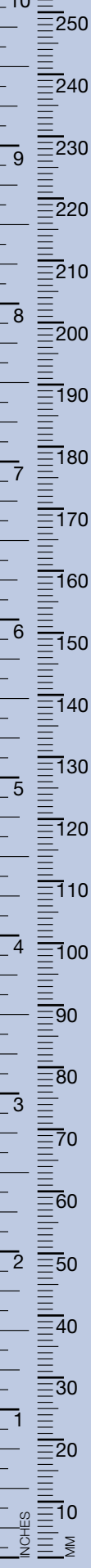

## DIEFFENBACH SERREFINES

Overall length 2<sup>1</sup>/<sub>4</sub>" (5.7cm).

<u>Item Number</u>	<u>Description</u>
MDS1210205	Straight



## NAIL NIPPER

Concave edge, double spring.

<u>Item Number</u>	<u>Description</u>
MDS7406013	Overall length 4 <sup>3</sup> / <sub>4</sub> " (12.1cm)
MDS7433614	Overall length 5 <sup>1</sup> / <sub>2</sub> " (14cm)



## NAIL NIPPERS

Concave edge. Barrel spring and catch in handles, screw lock.

<u>Item Number</u>	<u>Description</u>
MDS7436812	Overall length 4 <sup>3</sup> / <sub>4</sub> " (12.1cm)
MDS7436815	Overall length 5 <sup>1</sup> / <sub>2</sub> " (14cm)

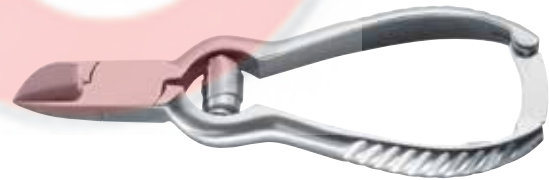

## CUTICLE NIPPER

Convex edge, double spring.

<u>Item Number</u>	<u>Description</u>
MDS7436511	Overall length 4" (10.2cm)



## NAIL NIPPER

Straight, double spring. Mirror finish.

<u>Item Number</u>	<u>Description</u>
MDS7436013	Overall length 5" (12.7cm)



## FOX DERMAL CURETTES

Overall length 5<sup>5</sup>/<sub>8</sub>" (14.3cm).

<u>Item Number</u>	<u>Description</u>
MDS7412803	Diameter 3mm
MDS7412804	Diameter 4mm
MDS7412805	Diameter 5mm
MDS7412806	Diameter 6mm



## KEYES SKIN PUNCHES

Overall length 3<sup>1</sup>/<sub>2</sub>" (8.9cm).

<u>Item Number</u>	<u>Description</u>
MDS7414002	Diameter 2mm
MDS7414003	Diameter 3mm
MDS7414004	Diameter 4mm
MDS7414005	Diameter 5mm
MDS7414006	Diameter 6mm
MDS7414007	Diameter 7mm
MDS7414008	Diameter 8mm



## SCHAMBERG COMEDO EXTRACTOR

Double-ended.

<u>Item Number</u>	<u>Description</u>
MDS7411110	Overall length 3 <sup>3</sup> / <sub>4</sub> " (9.5cm)



## HIRSCHMAN ANOSCOPES

<b>Item Number</b>	<b>Description</b>
MDS6821216	Small, diameter $\frac{9}{16}$ " (1.4cm), working length $2\frac{3}{4}$ " (7cm)
MDS6821219	Medium, diameter $1\frac{1}{16}$ " (1.7cm), working length $2\frac{3}{4}$ " (7cm)
MDS6821222	Large, diameter $\frac{7}{8}$ " (2.2cm), working length $2\frac{7}{8}$ " (7.3cm)



## FANSLER PROCTOSCOPE

Open at top. Diameter  $1\frac{1}{3}$ " (3.3cm).

<b>Item Number</b>	<b>Description</b>
MDS6821022	Working length $2\frac{3}{8}$ " (6cm)



## CHELSEA EATON ANAL SPECULA

Mirror finish. Overall length  $2\frac{1}{2}$ " (6.4cm).

<b>Item Number</b>	<b>Description</b>
MDS6821522	Small, diameter $\frac{7}{8}$ " (2.2cm)
MDS6821530	Large, diameter $1\frac{1}{4}$ " (3.1cm)



## VERNON-DAVID RECTAL SPECULUM

Diameter  $\frac{3}{4}$ " (2cm). Chrome plated.

<u>Item Number</u>	<u>Description</u>
MDS6821608	Overall length 3" (7.6cm)



## PRATT RECTAL SPECULUM

Improved bivalve type. Regular size. Mirror finish.

<u>Item Number</u>	<u>Description</u>
MDS6812100	Blades $3\frac{1}{2}$ " x 1" (8.9cm x 2.5cm) wide

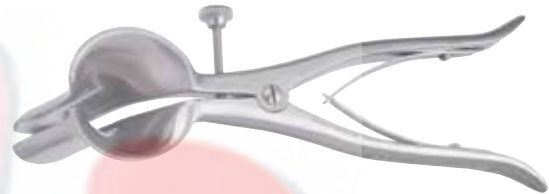

## HILL-FERGUSON RECTAL RETRACTORS

<u>Item Number</u>	<u>Description</u>
MDS1837501	Blade $2\frac{1}{2}$ " x $\frac{15}{16}$ " (6.4cm x 2.4cm) wide
MDS1837502	Blade 3" x $1\frac{1}{4}$ " (7.6cm x 3.2cm) wide
MDS1837503	Blade 3" x $1\frac{3}{8}$ " (7.6cm x 3.5cm) wide



## SAWYER RECTAL RETRACTOR

<u>Item Number</u>	<u>Description</u>
MDS9961066	11", $\frac{7}{8}$ " x $2\frac{1}{2}$ " (small)
MDS9961067	11", $1\frac{1}{8}$ " x 3" (medium)
MDS9961076	11", $1\frac{1}{2}$ " x $3\frac{1}{2}$ " (large)



## BUIE-SMITH ANAL RETRACTORS

Self-retaining. Swivel blades. Opens to 2<sup>1</sup>/<sub>8</sub>" (5.4cm).

<u>Item Number</u>	<u>Description</u>
MDS6815015	Short blade, 2 <sup>7</sup> / <sub>8</sub> " x 7 <sup>7</sup> / <sub>8</sub> " (7.3cm x 2.2cm) wide

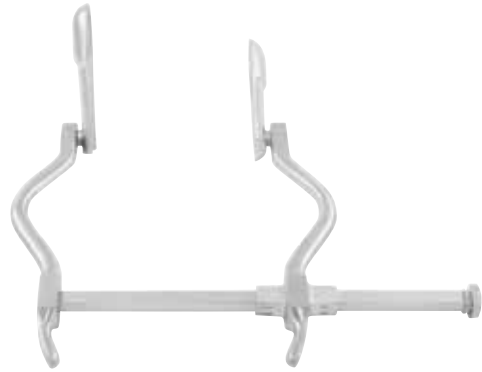

## PARKS ANAL RETRACTOR

Self-retaining. Swivel blades.

<u>Item Number</u>	<u>Description</u>
MDS1833914	Includes two sets of side blades and one center blade

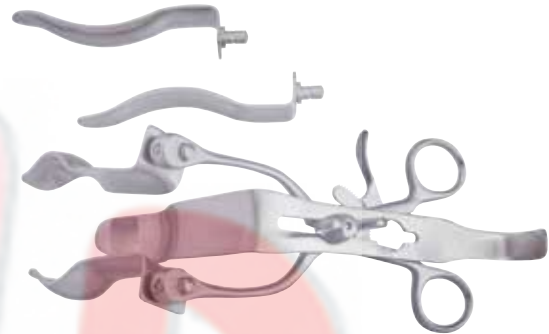

## ADAIR TISSUE FORCEPS

<u>Item Number</u>	<u>Description</u>
MDS6413015	Overall length 6 <sup>1</sup> / <sub>4</sub> " (15.9cm)
MDS6413023	Overall length 9" (22.9cm)

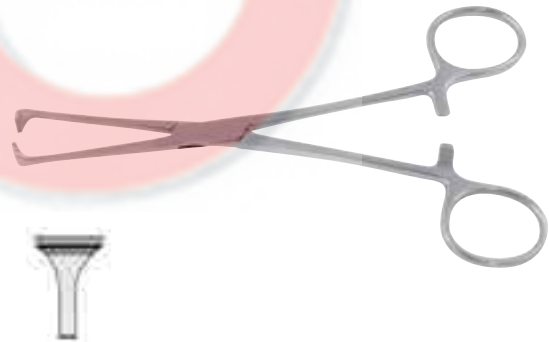

## FERGUSON TENACULUM FORCEPS

<u>Item Number</u>	<u>Description</u>
MDS6411416	Overall length 6 <sup>1</sup> / <sub>4</sub> " (15.9cm)





## PRATT-SMITH HEMOSTATIC FORCEPS

Concave, T-shaped jaws, with fine serrations.

<u>Item Number</u>	<u>Description</u>
MDS1236015	Overall length 6" (15.2cm)



## PENNINGTON HEMORRHOIDAL FORCEPS

Triangular open jaws have full horizontal serrations.

<u>Item Number</u>	<u>Description</u>
MDS1235815	Overall length 6 <sup>1</sup> / <sub>4</sub> " (15.9cm)

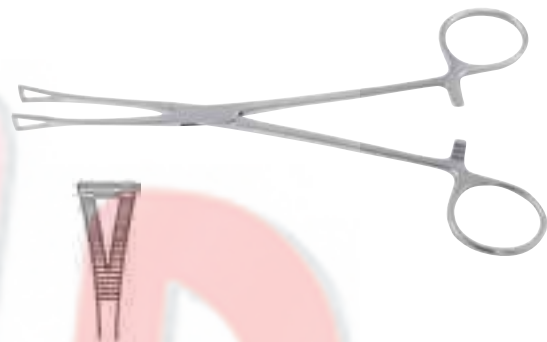

## BUIE PILE CLAMP

Model is serrated all the way to the heel of slightly curved and tapering jaws.

<u>Item Number</u>	<u>Description</u>
MDS1238121	Overall length 8 <sup>1</sup> / <sub>4</sub> " (21cm)

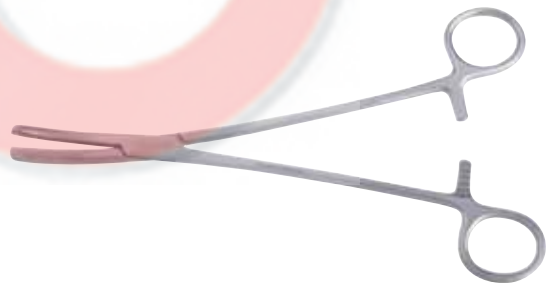

## BUIE FISTULA PROBES

Silver probe/stainless steel handle.  
Overall length 6<sup>1</sup>/<sub>2</sub>" (16.5cm).

<u>Item Number</u>	<u>Description</u>
MDS6825801	Light
MDS6824802	Heavy



## PRATT RECTAL PROBE

Malleable. Silver probe. Stainless steel handle.

<u>Item Number</u>	<u>Description</u>
MDS6825919	Overall length 10" (25.4cm)



## LARRY RECTAL DIRECTOR

Grooved. Chrome plated.

<u>Item Number</u>	<u>Description</u>
MDS2011815	Overall length 6" (15.2cm)



## BARR FISTULA PROBE

Double-ended. Chrome plated.

<u>Item Number</u>	<u>Description</u>
MDS6826214	Overall length 7" (17.8cm)



## ROSSER CRYPT HOOK

Matte and mirror finish.

<u>Item Number</u>	<u>Description</u>
MDS6825000	Overall length 6 <sup>5</sup> / <sub>8</sub> " (16.8cm)



## STEWART CRYPT HOOK

Overall length 9" (22.9cm).

<u>Item Number</u>	<u>Description</u>
MDS6825123	Short hook, length $7\frac{7}{8}$ " (2.2cm)



## MCGIVNEY HEMORRHOIDAL LIGATOR

<u>Item Number</u>	<u>Description</u>
MDS6840800	Set includes: ligating drum, cone, $7\frac{1}{2}$ " (19.4cm) grasping forceps, and one box latex "O" bands
MDS6843919	Grasping forceps $7\frac{1}{2}$ " (19.1cm)
MDS6840400	Latex "O" bands, for use with MDS6840800 and MDS6840500, box of 100



## HEMORRHOIDAL LIGATOR

With suction.

<u>Item Number</u>	<u>Description</u>
MDS6840500	Includes large and small suction heads and box of 100 latex "O" bands
MDS6840916	Large suction head for MDS6840500
MDS6840410	Hemorrhoidal ligator loading cone tip for MDS6840500

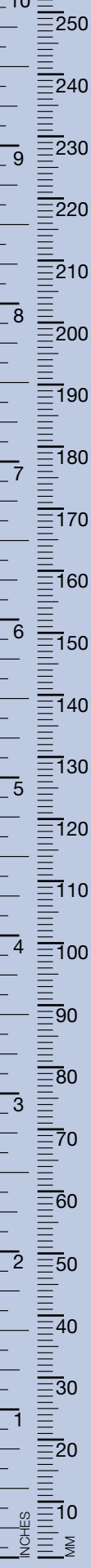
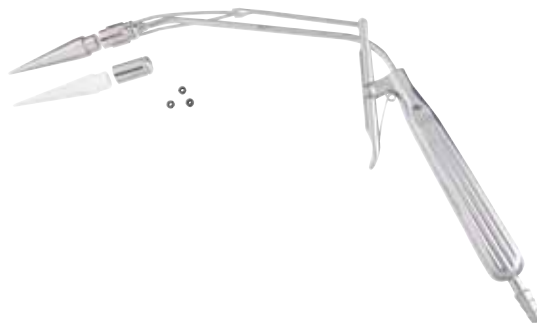

## GRAVES VAGINAL SPECULUM

Mirror finish.

<b>Item Number</b>	<b>Description</b>
MDS7011001	Small, blade 3" x $\frac{3}{4}$ " wide (7.6cm x 1.9cm)
MDS7011002	Medium, blade 4" x $1\frac{3}{8}$ " wide (10.2cm x 3.5cm)
MDS7011003	Large, blade 4 $\frac{1}{2}$ " x $1\frac{3}{8}$ " wide (11.5cm x 3.5cm)



## GRAVES EXPANDED VIEW VAGINAL SPECULA

40mm opening.

<b>Item Number</b>	<b>Description</b>
MDS7011011	Small, 4" (10.2cm)
MDS7011012	Medium, 4 $\frac{1}{2}$ " (11.5cm)
MDS7011013	Large, 5" (12.5cm)



## GRAVES OPEN SIDE VAGINAL SPECULUM

Angled at 45 degrees.

<b>Item Number</b>	<b>Description</b>
MDS7011202	Medium, with ratchet lock, 4" x $1\frac{3}{8}$ " wide (10.2cm x 3.5cm)



## PEDERSON VAGINAL SPECULUM

Mirror finish.

<b>Item Number</b>	<b>Description</b>
MDS7012001	Small, 3" x 1/2" wide (7.6cm x 1.3cm)
MDS7012002	Medium, 4" x 7/8" wide (10.2cm x 2.2cm)
MDS7012003	Large, 4 3/4" x 1" wide (12cm x 2.5cm)



## GARRIGUE VAGINAL SPECULUM

3 lbs. Weighted.

<b>Item Number</b>	<b>Description</b>
MDS7019491	3" x 1 1/2" wide (7.6cm x 3.8cm)

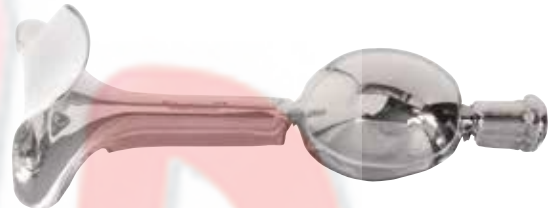

## AUVARD VAGINAL SPECULUM

2.5 lbs. Weighted. Mirror finish.

<b>Item Number</b>	<b>Description</b>
MDS7030801	2 3/4" x 1 1/2" wide (7cm x 3.8cm)
MDS7030800	4" x 1 1/4" wide (10.2cm x 3.2cm)



## STEINER SPECULUM

2.5 lbs. Weighted. Mirror finish.

<b>Item Number</b>	<b>Description</b>
MDS7030600	Blade 5 1/2" x 1 1/4" wide (14cm x 3.2cm)



## KOGAN ENDOSPECULUM

Fenestrated blades and finger rings bent outward in opposite directions permit examination of the urethra and cervix. Spring-closed blades open when finger rings are pressed together. With gauge.



<u>Item Number</u>	<u>Description</u>
MDS7036024	Overall length 9 $\frac{1}{2}$ " (24.1cm), with screw lock
MDS7035603	Overall length 9 $\frac{1}{2}$ " (24.1cm)), with ratchet

## DE LEE UNIVERSAL RETRACTOR

<u>Item Number</u>	<u>Description</u>
MDS1803452	Blade 2 $\frac{3}{4}$ " x 2" wide (7cm x 5.1cm), overall length 9" (22.9cm)



## JACKSON VAGINAL RETRACTORS

Overall length 6 $\frac{7}{8}$ " (17.5cm).

<u>Item Number</u>	<u>Description</u>
MDS7027101	Small, 3" x 1 $\frac{3}{8}$ " wide (7.6cm x 3.5cm)
MDS7027102	Medium, 3 $\frac{1}{2}$ " x 1 $\frac{3}{8}$ " wide (8.9cm x 3.5cm)
MDS7027103	Large, 4" x 1 $\frac{5}{8}$ " wide (10.2cm x 4.1cm)



## EASTMAN VAGINAL RETRACTORS

Overall length 6 $\frac{7}{8}$ " (17.5cm).

<u>Item Number</u>	<u>Description</u>
MDS7029032	Small, 3" x 1 $\frac{3}{8}$ " wide (7.6cm x 3.5cm)
MDS7029038	Medium, 3 $\frac{1}{2}$ " x 1 $\frac{3}{8}$ " wide (8.9cm x 3.5cm)
MDS7029045	Large, 4" x 1 $\frac{5}{8}$ " wide (10.2cm x 4.1cm)





## RIGHBY RETRACTORS

Item Number	Description
MDS1880635	1 <sup>3</sup> / <sub>8</sub> " x <sup>3</sup> / <sub>4</sub> " (3.5cm x 2cm), overall length 7" (18cm)
MDS1880660	2 <sup>3</sup> / <sub>8</sub> " x <sup>3</sup> / <sub>4</sub> " (6cm x 2cm), overall length 7" (18cm)
MDS1880665	2 <sup>9</sup> / <sub>16</sub> " x <sup>5</sup> / <sub>8</sub> " (6.5cm x 1.5cm), overall length 7" (18cm)



## LATERAL WALL RETRACTOR

For use inside vaginal speculum. Closed shanks.

Item Number	Description
MDS7031722	Blade length 2 <sup>1</sup> / <sub>2</sub> " (6.4cm)

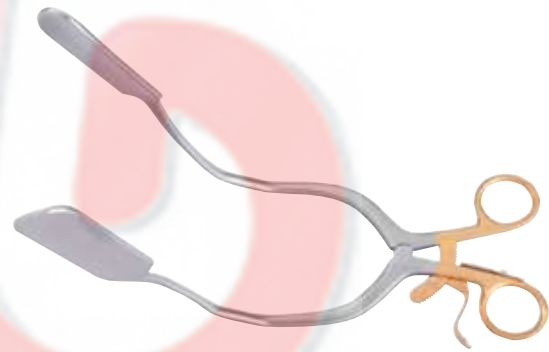

## O'SULLIVAN-O'CONNOR VAGINAL SPECULUM

Item Number	Description
MDS7019600	Complete set with 5 blades (2 fixed and 3 interchangeable)
MDS7019601	Frame only
MDS7019602	Blade 1 <sup>3</sup> / <sub>4</sub> " x <sup>3</sup> / <sub>4</sub> " wide
MDS7019603	Blade 3 <sup>1</sup> / <sub>2</sub> " x 1 <sup>1</sup> / <sub>4</sub> " wide
MDS7019604	Blade 3 <sup>1</sup> / <sub>2</sub> " x 1 <sup>3</sup> / <sub>4</sub> " wide



MDS7019602 MDS7019603 MDS7019604

## SIMS UTERINE SCISSORS

Overall length (20.3cm).

<u>Item Number</u>	<u>Description</u>
MDS0851220	Straight. Sharp/blunt
MDS0851020	Straight. Blunt/blunt
MDS0851620	Straight. Sharp/sharp
MDS0851720	Curved. Sharp/blunt
MDS0851120	Curved. Blunt/blunt
MDS0851820	Curved. Sharp/sharp

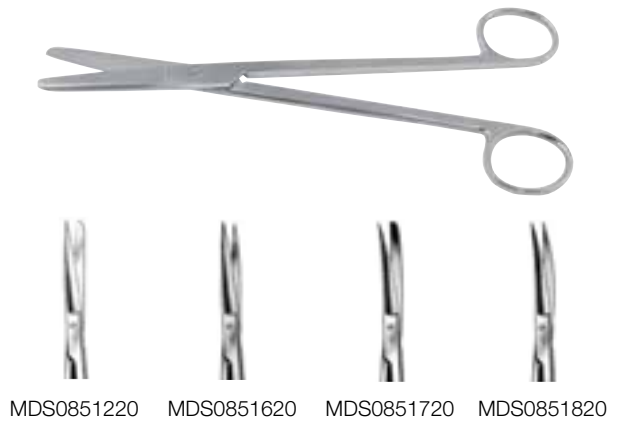

## KELLY UTERINE SCISSORS

Short blades. Sharp/sharp. Mirror finish.  
Overall length 6¼" (15.9cm).

<u>Item Number</u>	<u>Description</u>
MDS0854016	Straight
MDS0854116	Curved

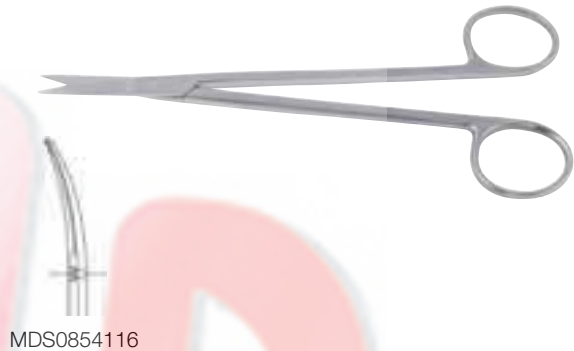

## BRAUN EPISIOTOMY SCISSORS

Angled.

<u>Item Number</u>	<u>Description</u>
MDS0856014	Overall length 6" (15.2cm)
MDS0856022	Overall length 8" (20.3cm)

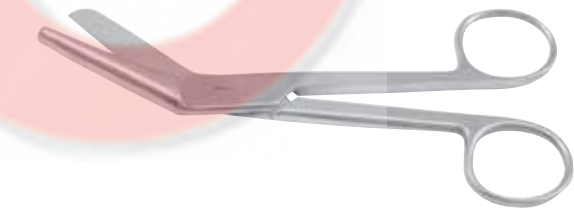

## WALDMANN EPISIOTOMY SCISSORS

Curved, slight serrations.

<u>Item Number</u>	<u>Description</u>
MDS0855518	Overall length 7⅛" (18cm)



## AMERICAN PATTERN UMBILICAL SCISSORS

Straight.

<u>Item Number</u>	<u>Description</u>
MDS0855010	Overall length 4" (10.2cm)



## MOYNIHAN-NAVRATIL FORCEPS

Angled.

<u>Item Number</u>	<u>Description</u>
MDS1614371	Overall length 7 <sup>7</sup> / <sub>8</sub> " (20cm)

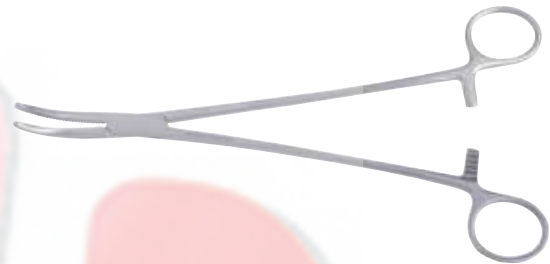

## FOERSTER SPONGE FORCEPS

Straight, serrated.

<u>Item Number</u>	<u>Description</u>
MDS1617025	Overall length 9 <sup>3</sup> / <sub>4</sub> " (24.8cm)
MDS1677030	Overall length 12" (30.5cm)
MDS1677035	Overall length 14" (35.6cm)
MDS1677040	Overall length 16" (40.6cm)

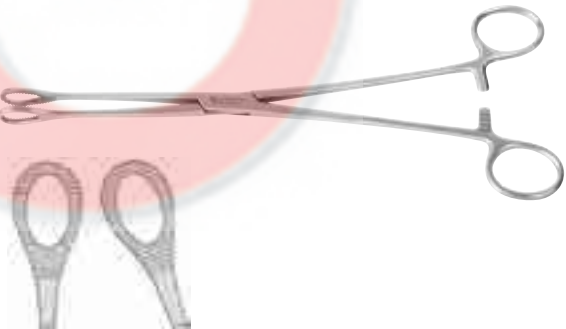

## BRAUN UTERINE TENACULUM FORCEPS

Straight.

<u>Item Number</u>	<u>Description</u>
MDS7050425	Overall length 10" (25.4cm)



## BARRETT UTERINE TENACULUM FORCEPS

Straight.

<u>Item Number</u>	<u>Description</u>
MDS7051018	Overall length 7" (17.8cm)



## SKENE UTERINE TENACULUM FORCEPS

Curved on side

<u>Item Number</u>	<u>Description</u>
MDS7050524	Overall length 9½" (24.1cm)



## DE LEE CERVIX HOLDING FORCEPS

Straight, serrated.

<u>Item Number</u>	<u>Description</u>
MDS7054027	Overall length 9½" (24.1cm)

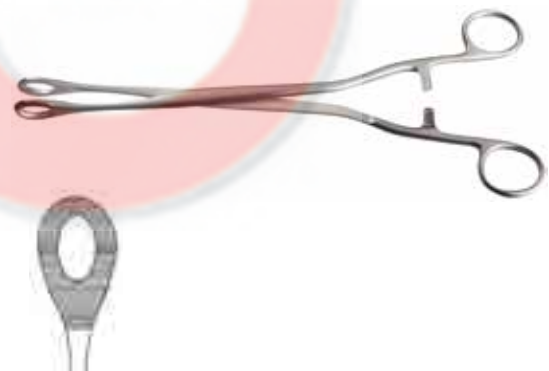

## ADAIR UTERINE TENACULUM FORCEPS

Straight.

<u>Item Number</u>	<u>Description</u>
MDS7050885	Overall length 7½" (19cm)



## DUPLAY UTERINE TENACULUM FORCEPS

Curved.

<u>Item Number</u>	<u>Description</u>
MDS7050728	Overall length 10" (25.4cm)



## JARCHO UTERINE TENACULUM FORCEPS

<u>Item Number</u>	<u>Description</u>
MDS7051220	Overall length 9" (22.9cm)

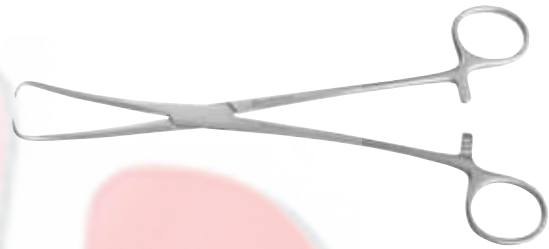

## POZZI TENACULUM FORCEPS

<u>Item Number</u>	<u>Description</u>
MDS7051825	Overall length 10" (25.4cm)



## TEALE TENACULUM FORCEPS

<u>Item Number</u>	<u>Description</u>
MDS7053123	Curved, 3 x 4 teeth. Overall length 10 <sup>1</sup> / <sub>8</sub> " (25.7cm)



## SCHROEDER UTERINE VULSELLUM FORCEPS

Overall length 9 $\frac{7}{8}$ " (25cm).

<u>Item Number</u>	<u>Description</u>
--------------------	--------------------

MDS7051424	Straight
------------	----------

MDS7051525	Curved
------------	--------

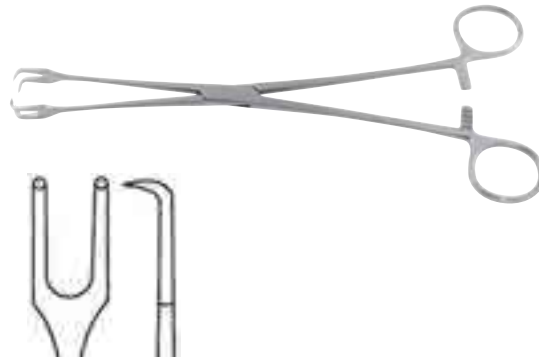

## GORDON UTERINE VULSELLUM FORCEPS

Straight. 3 x 3 prongs.

<u>Item Number</u>	<u>Description</u>
--------------------	--------------------

MDS7052024	Overall length 9 $\frac{1}{2}$ " (24.1cm)
------------	---

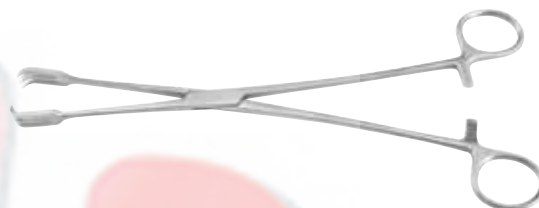

## JACOB UTERINE VULSELLUM FORCEPS

2 x 2 teeth. Overall length 8 $\frac{1}{2}$ " (21.6cm).

<u>Item Number</u>	<u>Description</u>
--------------------	--------------------

MDS7053221	Straight
------------	----------

MDS7053321	Curved on side
------------	----------------

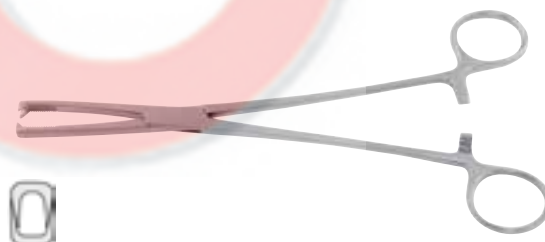

## HENROTIN UTERINE VULSELLUM FORCEPS

Straight. 2 x 3 teeth.

<u>Item Number</u>	<u>Description</u>
--------------------	--------------------

MDS7050970	Overall length 8 $\frac{1}{4}$ " (21cm)
------------	---





## HULKA-KENWICK UTERINE ELEVATING & MANIPULATING FORCEPS

<u>Item Number</u>	<u>Description</u>
MDS7053030	Overall length 11 <sup>1</sup> / <sub>4</sub> " (28.6cm)



## HEANEY HYSTERECTOMY FORCEPS

Curved, longitudinal serrations.

<u>Item Number</u>	<u>Description</u>
MDS1260121	Overall length 8 <sup>1</sup> / <sub>4</sub> " (21cm)



## HEANEY-REZEK HYSTERECTOMY FORCEPS

Straight, criss-cross serrations.

<u>Item Number</u>	<u>Description</u>
MDS1260021	Overall length 8 <sup>1</sup> / <sub>4</sub> " (21cm)

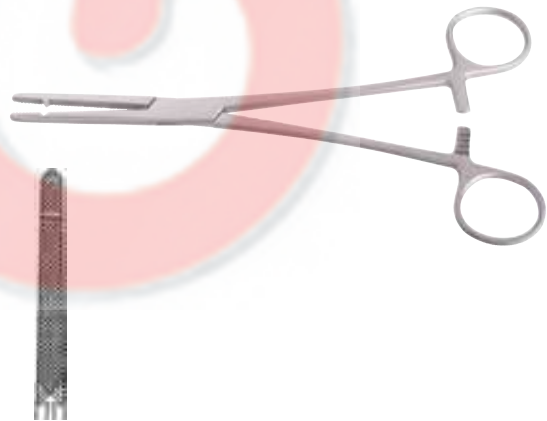

## HEANEY-KANTER HYSTERECTOMY FORCEPS

Curved. Additional wide tooth.

<u>Item Number</u>	<u>Description</u>
MDS1204721	Overall length 8 <sup>1</sup> / <sub>4</sub> " (21cm)

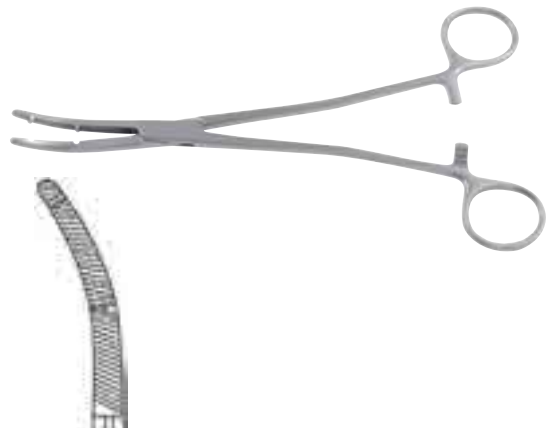

## BALLENTINE HYSTERECTOMY FORCEPS

Straight, longitudinal grooves.

<u>Item Number</u>	<u>Description</u>
MDS1259420	Overall length 8¼" (21cm)

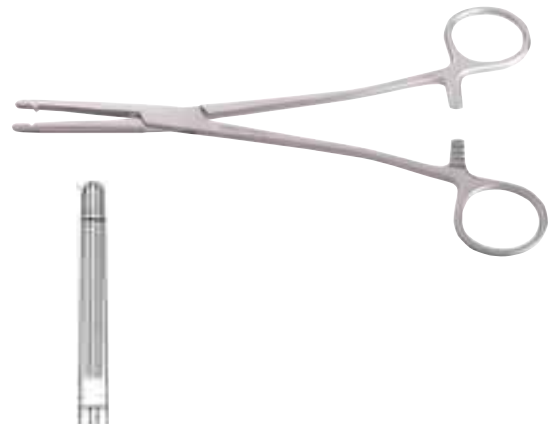

## GLENNER HYSTERECTOMY FORCEPS

Overall length 8¼" (21cm).

<u>Item Number</u>	<u>Description</u>
MDS1260501	Curved left for patients right
MDS1260502	Curved right for patients left

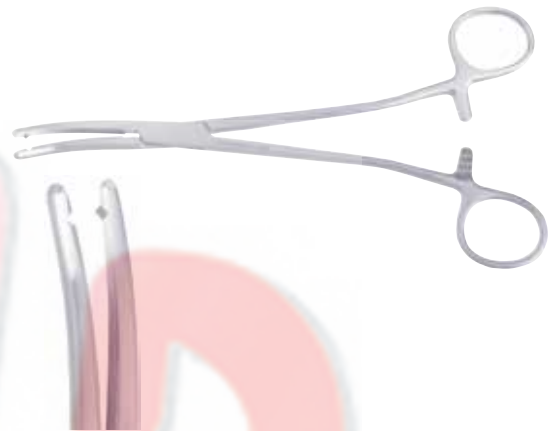

## REICH-NECHTOW HYSTERECTOMY FORCEPS

Overall length 8¼" (21cm).

<u>Item Number</u>	<u>Description</u>
MDS7053131	Curved
MDS7053130	Straight

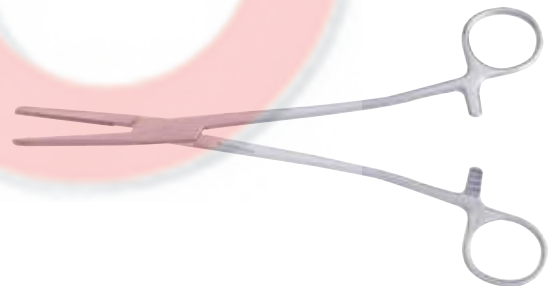

## HEANEY CLAMP

<u>Item Number</u>	<u>Description</u>
MDS7053124	Curved, overall length 12" (30.5cm)



### ROGERS HYSTERECTOMY FORCEPS

2 x 3 atraumatic teeth. Overall length 8¾" (22.2cm).

<u>Item Number</u>	<u>Description</u>
MDS7053188	Straight
MDS7053189	Curved



### MASTERTSON HYSTERECTOMY FORCEPS

2 x 3 atraumatic teeth.

<u>Item Number</u>	<u>Description</u>
MDS7053268	Straight, overall length 8½" (21.6cm)
MDS7053269	Curved, overall length 8½" (21.6cm)



### CLARK HYSTERECTOMY CLAMP

<u>Item Number</u>	<u>Description</u>
MDS7053311	Overall length 14" (35.6cm)

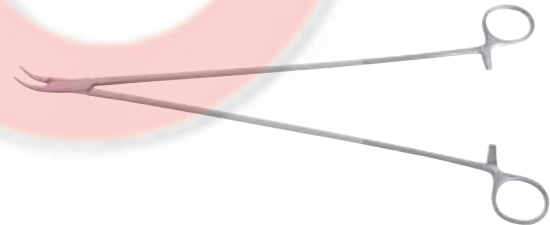

### POWELL-WERTHEIM HYSTERECTOMY FORCEPS

<u>Item Number</u>	<u>Description</u>
MDS1257125	Seven ratchets, overall length 10" (25.4cm)



## Z-TYPE HYSTERECTOMY CLAMPS

Straight Handle		Slightly		
Overall Length	Straight Jaws	Curved Jaws	Curved Jaws	Angled Jaws
9½" (24cm)	MDS7026201	MDS7026202	MDS7026203	MDS7026204
12" (30.5cm)	MDS7064201	MDS7064202	MDS7064203	MDS7064204
14" (35.6cm)	MDS7066201	MDS7066202	MDS7066203	MDS7066204
16" (40.6cm)	MDS7068201	MDS7068202	MDS7068203	MDS7068204

Offset Handle		Slightly		
Overall Length	Straight Jaws	Curved Jaws	Curved Jaws	Angled Jaws
9½" (24cm)	MDS7063205	MDS7063206	MDS7063207	MDS7063208
12" (30.5cm)	MDS7064205	MDS7064206	MDS7064207	MDS7064208
14" (35.6cm)	MDS7066205	MDS7066206	MDS7066207	MDS7066208

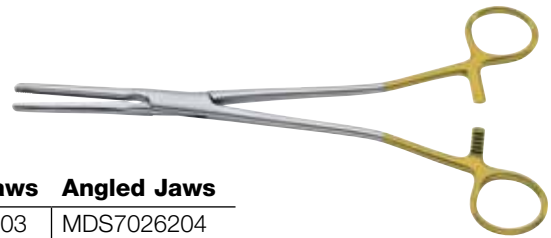

## PHANEUF HYSTERECTOMY FORCEPS

Serrated. 1 x 2 teeth.

Item Number	Description
MDS1255421	Straight, overall length 8½" (21.6cm)
MDS1255521	Angled on flat, overall length 8½" (21.6cm)

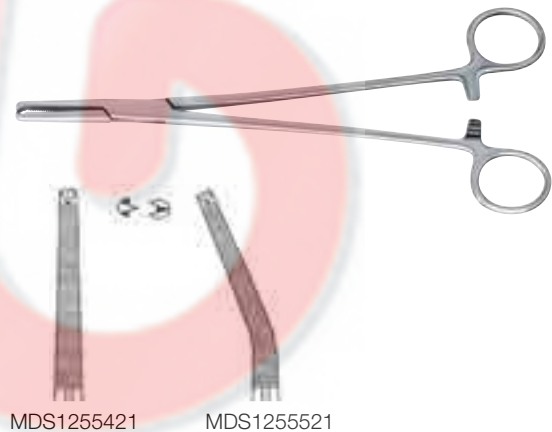

MDS1255421

MDS1255521

## WERTHEIM-CULLEN PEDICLE FORCEPS

Angled, longitudinal serrations.

Item Number	Description
MDS1257921	Overall length 8½" (21.6cm)

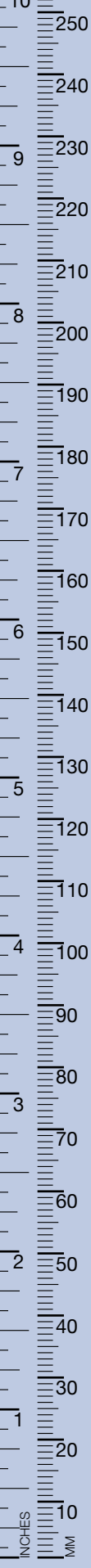

## HEGAR UTERINE DILATORS

Hollow, double ended.  
Overall length 7½" (19cm).

<b>Item Number</b>	<b>Description</b>
MDS7042001	Size 1-2
MDS7042003	Size 3-4
MDS7042005	Size 5-6
MDS7042007	Size 7-8
MDS7042009	Size 9-10
MDS7042011	Size 11-12
MDS7042013	Size 13-14
MDS7042015	Size 15-16
MDS7042017	Size 17-18



## PRATT UTERINE DILATORS

Solid, double ended, overall length 11½" (29.2cm).  
Mirror finish.

<b>Item Number</b>	<b>Description</b>
MDS7044708	Set of 8
MDS7043913	Size 13-15Fr
MDS7043917	Size 17-19Fr
MDS7043921	Size 21-23Fr
MDS7043925	Size 25-27Fr
MDS7044729	Size 29-31Fr
MDS7044733	Size 33-35Fr
MDS7044737	Size 37-39Fr
MDS7044741	Size 41-43Fr



## HANK UTERINE DILATORS

Double ended. Mirror finish. Solid.

Item Number	Description
MDS7043506	Set of 6
MDS7043010	Size 9-10Fr
MDS7043012	Size 11-12Fr
MDS7043014	Size 13-14Fr
MDS7043016	Size 15-16Fr
MDS7043018	Size 17-18Fr
MDS7043020	Size 19-20Fr



## SIMS UTERINE CURETTES

Sharp. Malleable.  
Overall length 11" (27.9cm).

Item Number	Description
MDS7071505	Size 00
MDS7071506	Size 0
MDS7071507	Size 1
MDS7071508	Size 2
MDS7071509	Size 3
MDS7071511	Size 4
MDS7071512	Size 5
MDS7071514	Size 6



## HUNTER LARGE UTERINE CURETTE

Overall Length 12½" (31.8cm)

Item Number	Description
MDS7076008	Blade 3cm wide, working length 8" (20.3cm)





## SIMS UTERINE CURETTES

Sharp/rigid, overall length 11" (27.9cm).

Item Number	Description
MDS7071007	Size 1
MDS7071008	Size 2
MDS7071009	Size 3
MDS7071011	Size 4
MDS7071012	Size 5
MDS7071014	Size 6



## HEANEY UTERINE CURETTE

Serrated cutting edge, malleable. 5mm wide.

Item Number	Description
MDS7059824	Overall length 9½" (24.1cm)



## KELLY-GRAY UTERINE CURETTES

Double sided. Serrated cutting edge.  
Overall length 9½" (24.1cm).

Item Number	Description
MDS7075005	Size 1, (5cm)
MDS7075006	Size 2, (6cm)
MDS7075007	Size 3, (7cm)
MDS7075009	Size 4, (8cm)

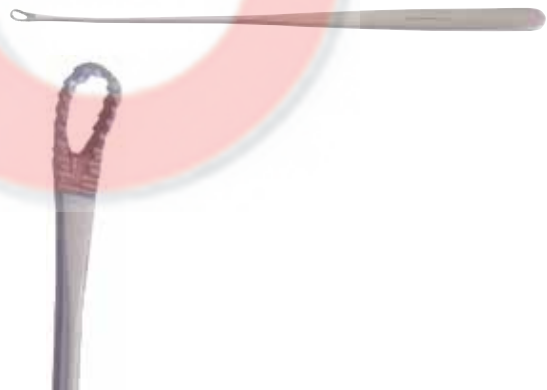

## RANDALL ENDOMETRIAL BIOPSY SUCTION CURETTES

Luer lock hub.

Item Number	Description
MDS7059004	Outside dia. 4mm, overall length 9¼" (23.5cm)
MDS7059003	Outside dia. 3mm, overall length 9½" (24.1cm)



## NOVAK ENDOMETRIAL BIOPSY SUCTION CURETTE

Curved, with Luer lock hub. 4mm diameter.

<u>Item Number</u>	<u>Description</u>
MDS7059204	Overall length 9" (22.9cm)



## KEVORKIAN-YOUNGE ENDOCERVICAL BIOPSY CURETTES

Slightly curved.

<u>Item Number</u>	<u>Description</u>
MDS7059440	Overall length 11¼" (30cm)
MDS7059640	With basket, overall length 11¼" (30cm)



MDS7059440

MDS7059640

## OVERSTREET ENDOMETRIAL POLYP FORCEPS

<u>Item Number</u>	<u>Description</u>
MDS70518001	Hollow, fenestrated jaw, overall length 9" (22.9cm)



## FLETCHER-VAN DOREN UTERINE POLYP SPONGE HOLDING FORCEPS

Double curved.

<u>Item Number</u>	<u>Description</u>
MDS1623524	Overall length 9½" (24.1cm)

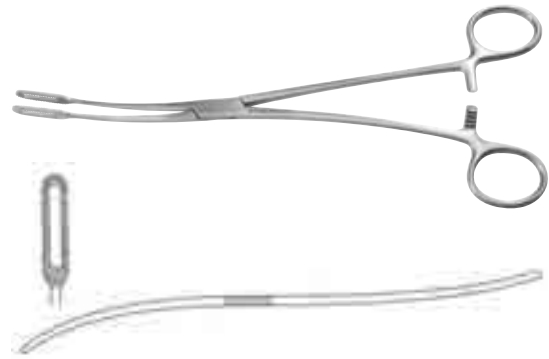

## GAYLOR UTERINE SPECIMEN FORCEPS

Angled, sharp, cup-shaped jaws.

<u>Item Number</u>	<u>Description</u>
MDS7067111	Overall length 9" (22.9cm)



## THOMAS-GAYLOR UTERINE BIOPSY PUNCH

Angled, sharp, cup-shaped jaws.

<u>Item Number</u>	<u>Description</u>
MDS7060624	Overall length 9" (22.9cm)

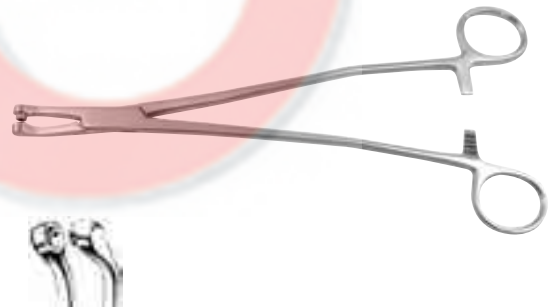

## SCHUBERT UTERINE BIOPSY PUNCH FORCEPS

Overall length 8½" (21.6cm).

<u>Item Number</u>	<u>Description</u>
MDS7060421	Straight
MDS7060422	Curved



## KEVORKIAN-YOUNGE BIOPSY FORCEPS

Narrow jaws. Fine teeth in lower jaw; serrations on sides with sharp cutting edges.

<u>Item Number</u>	<u>Description</u>
MDS7067201	Cup size 8.5mm x 3.5mm, overall length 10" (25.4cm)



## EPPENDORFER CERVICAL BIOPSY FORCEPS

<u>Item Number</u>	<u>Description</u>
MDS7063001	3.5mm x 8mm cup, working length 8" (20.3cm)

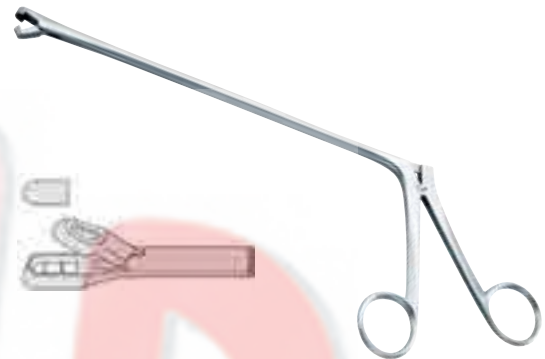

## VAN DOREN UTERINE BIOPSY PUNCH FORCEPS

Angled.

<u>Item Number</u>	<u>Description</u>
MDS7074325	Overall length 10" (25.4cm)

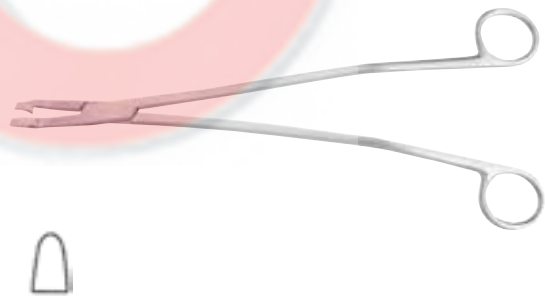

## SCHUBERT CERVICAL BIOPSY PUNCH FORCEPS

<u>Item Number</u>	<u>Description</u>
MDS7060428	Overall length 8 1/2" (21.6cm)



## TISCHLER CERVICAL BIOPSY PUNCH FORCEPS

Item Number	Description
MDS7059927	3mm x 7mm, overall length 10 <sup>1</sup> / <sub>2</sub> " (26.7cm)
MDS7063101	Working length 9" (22.9cm)
MDS7067211	Oblong specimen 5mm x 2.5mm x 1.5mm, working length 8 <sup>3</sup> / <sub>4</sub> " (22.2cm)
MDS7062101R	Rotating, 3mm x 7mm, working length 9" (22.9cm), overall length 12" (30.5cm)
MDS7062101	Non-rotating, 3mm x 7mm, working length 9" (22.9cm), overall length 12" (30.5cm)
MDS7063104R	Rotating, 2mm x 4mm, working length 9" (22.9cm), overall length 12" (30.5cm)
MDS7063104	Non-rotating, 2mm x 4mm, working length 9" (22.9cm), overall length 12" (30.5cm)



## IOWA MEMBRANE PUNCTURING FORCEPS

Item Number	Description
MDS7053926	Overall length 10 <sup>1</sup> / <sub>4</sub> " (26cm)



## MIYA TYPE HOOK

Hook depth 2.5cm.

Item Number	Description
MDS7084611	Shaft length 7" (17.8cm)



## KAHN UTERINE TRIGGER CANNULA

Contains 3 Teflon® tips.

<u>Item Number</u>	<u>Description</u>
MDS7082291	Overall length 13 <sup>1</sup> / <sub>4</sub> " (43.5cm)



## JARCHO UTERINE CANNULA

Malleable tip.

<u>Item Number</u>	<u>Description</u>
MDS5200116	Overall length 12 <sup>1</sup> / <sub>2</sub> " (31.8cm)



## BRAUN UTERINE TENACULUM FORCEPS

<u>Item Number</u>	<u>Description</u>
MDS7050425C	Straight, insulated tips, overall length 9 <sup>1</sup> / <sub>2</sub> " (24.1cm)

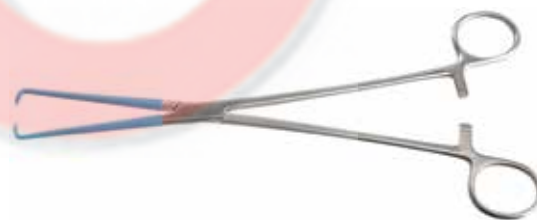

## KOGAN ENDOSPECULUM

Insulated, angled.

<u>Item Number</u>	<u>Description</u>
MDS7036024C	With ratchet, overall length 9 <sup>3</sup> / <sub>4</sub> " (24.8cm)
MDS7035603C	With set screw, overall length 9 <sup>3</sup> / <sub>4</sub> " (24.8cm)





## REDUNDANT WALL RETRACTOR

Insulated blades, 9cm x 2cm.

<u>Item Number</u>	<u>Description</u>
MDS7031822C	Overall length 7" (17.8cm)



## LATERAL WALL RETRACTOR INSULATED

For use inside vaginal speculum. Closed shanks.

<u>Item Number</u>	<u>Description</u>
MDS7031722C	Blade length 2 1/2" (6.4cm)

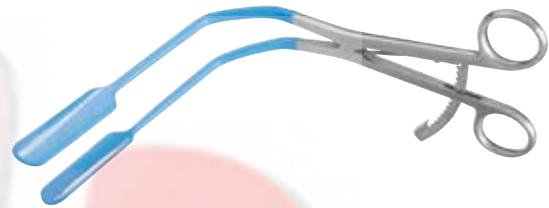

## GRAVES VAGINAL SPECULUM

Insulated.

<u>Item Number</u>	<u>Description</u>
MDS7011001C	Small, 3" x 3/4" wide (7.6cm x 1.9cm)
MDS7011002C	Medium, 4" x 1 3/8" wide (10.2cm x 3.5cm)
MDS7011003C	Large, 4 1/2" x 1 3/8" wide (11.5cm x 3.5cm)



## CAMPBELL SUPRAPUBIC TROCAR AND CANNULA

Cannula graduated in centimeters, grooved to accommodate 20Fr Foley catheter.

<u>Item Number</u>	<u>Description</u>
MDS2217216	Size 26Fr, working length 5 <sup>7</sup> / <sub>8</sub> " (15cm)



## OCHSNER TROCARS

Mirror finish. Overall length 5<sup>3</sup>/<sub>4</sub>" (14.5cm).

<u>Item Number</u>	<u>Description</u>
MDS2215010	14Fr for 10Fr catheter
MDS2215012	18Fr for 12Fr catheter
MDS2215014	20Fr for 14Fr catheter
MDS2215016	22Fr for 16Fr catheter
MDS2215018	24Fr for 18Fr catheter
MDS2215020	27Fr for 20Fr catheter



## NO-SCALPEL VASECTOMY FORCEPS

Sharp-pointed smooth jaw. Curved.

<u>Item Number</u>	<u>Description</u>
MDS5514494	Overall length 5" (12.7cm)

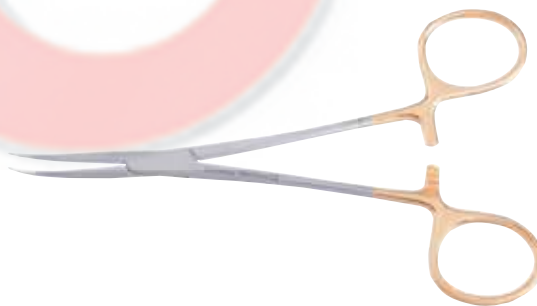

## NO-SCALPEL VASECTOMY FIXATOR RING CLAMP

Blunt tips.

<u>Item Number</u>	<u>Description</u>
MDS5514499	Overall length 5 <sup>1</sup> / <sub>2</sub> " (14cm)

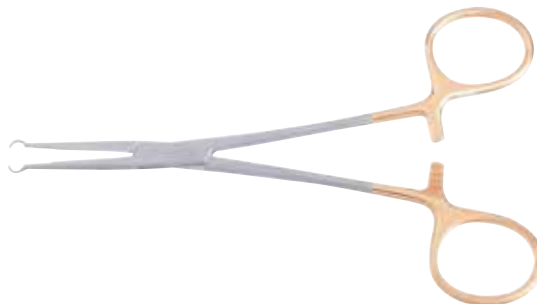

## SANDERS VASECTOMY FORCEPS

Used to isolate a segment of the vas deferens.

<u>Item Number</u>	<u>Description</u>
MDS5536656	Overall length 6 $\frac{1}{8}$ " (15.6cm)

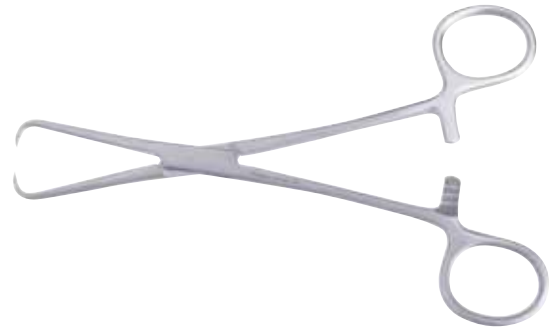

## YOUNG LATERAL RETRACTOR

<u>Item Number</u>	<u>Description</u>
MDS6610121	Blade 2 $\frac{1}{8}$ " x 7 $\frac{1}{16}$ " (5.4cm x 1cm), overall length 8 $\frac{5}{8}$ " (21.9cm)



## YOUNG ANTERIOR RETRACTOR

Acute angle.

<u>Item Number</u>	<u>Description</u>
MDS6610322	Blade 2 $\frac{3}{8}$ " x 1 $\frac{1}{2}$ " (6cm x 3.8cm) wide, overall length 8 $\frac{3}{8}$ " (21.3cm)



## YOUNG BULB RETRACTOR

Curved blade, notched.

<u>Item Number</u>	<u>Description</u>
MDS6610521	Blade 1" x 1" (2.5cm x 2.5cm), overall length 8 $\frac{3}{4}$ " (22.2cm)



## MILLIN T-SHAPED ANGLED FORCEPS

<u>Item Number</u>	<u>Description</u>
MDS6611123	Overall length 9" (23cm)

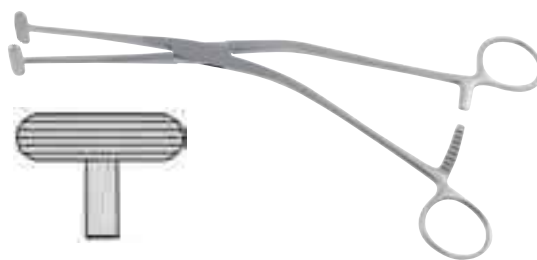

## MCDUGAL-TYPE PROSTATECTOMY CLAMPS

Overall length 10½" (26.7cm).

<u>Item Number</u>	<u>Description</u>
MDS5513499	Angled left
MDS5519494	Angled right



## MILLIN CAPSULE-GRASPING FORCEPS

<u>Item Number</u>	<u>Description</u>
MDS6612323	Overall length 9" (23cm)

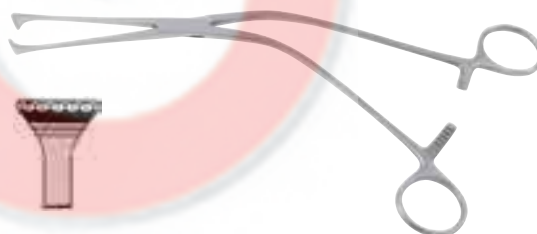

## HERRICK KIDNEY PEDICLE CLAMP

Double-angled, serrated jaws.

<u>Item Number</u>	<u>Description</u>
MDS1252323	Overall length 9½" (24.1 cm)



## GUYON-PEAN VESSEL CLAMP

Full double-curved blades with horizontal serrations.

Item Number	Description
MDS1251924	Overall length 9½" (24.1cm)



## RANDALL KIDNEY STONE FORCEPS

Item Number	Description
MDS6223101	Quarter curved, No. 1, overall length 9" (23cm)
MDS6223102	Half curved, No. 2, overall length 8¾" (22cm)
MDS6223103	Three-quarter curved, No. 3, overall length 8¾" (22cm)
MDS6223104	Fully curved, overall length 8¾" (22cm)

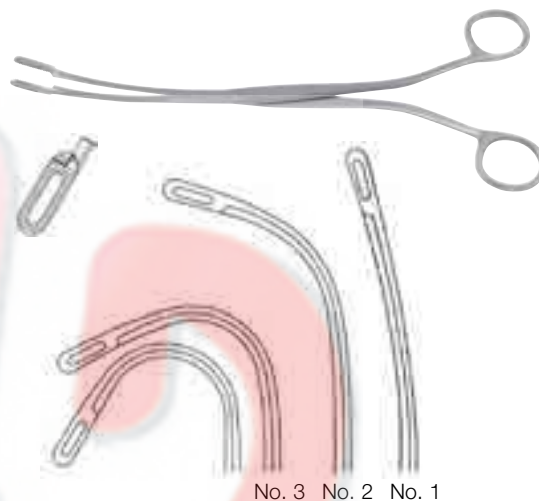

## GIL-VERNET RENAL SINUS RETRACTORS

Overall length 9½" (24.1cm).

Item Number	Description
MDS1826509	Blade 9mm wide
MDS1826511	Blade 11mm wide
MDS1826513	Blade 13mm wide
MDS1826515	Blade 15mm wide
MDS1826518	Blade 18mm wide



## ZIPSER PENILE CLAMP

Item Number	Description
MDS5597111	Overall length 4¼" (10.8cm)

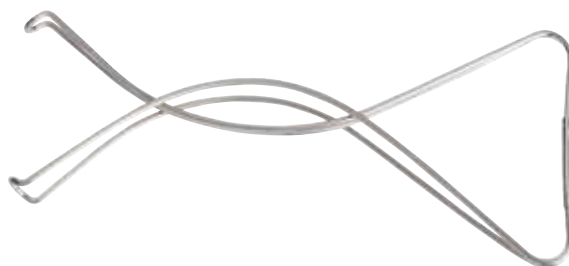

## SEDILLOT PERIOSTEAL ELEVATOR

Broad rounded blade 19mm wide.

<u>Item Number</u>	<u>Description</u>
MDS3270921	Overall length 7½" (19cm)



## GLUCK RIB SHEARS

<u>Item Number</u>	<u>Description</u>
MDS5610722	Overall length 7¾" (19.6cm)



## GIERTZ-SHOEMAKER RIB SHEARS

<u>Item Number</u>	<u>Description</u>
MDS5613727	Overall length 9¾" (24.8cm)



## COOLEY FIRST RIB SHEARS

Angled cutting surface and sturdy design permits quick, clean cuts in most rib cutting procedures.

<u>Item Number</u>	<u>Description</u>
MDS5610350	Heavy, curved blades, overall length 14" (35.6cm)





## SAUERBRUCH RIB SHEARS

<u>Item Number</u>	<u>Description</u>
MDS5613126	Overall length 10½" (26.7cm)



## BETHUNE RIB SHEARS

<u>Item Number</u>	<u>Description</u>
MDS5612634	Overall length 13¾" (34cm)



## CORYLLOS-BETHUNE RIB SHEARS

Protected points. Overall length 14" (35.6cm).

<u>Item Number</u>	<u>Description</u>
MDS5612635	Right
MDS5612735	Left

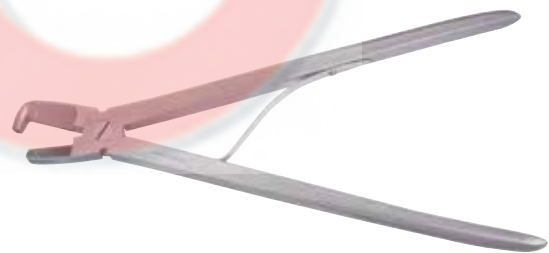

## CORYLLOS RIB SHEARS

Protected points. Overall length 12" (30cm).

<u>Item Number</u>	<u>Description</u>
MDS5612535	Right
MDS5612335	Left

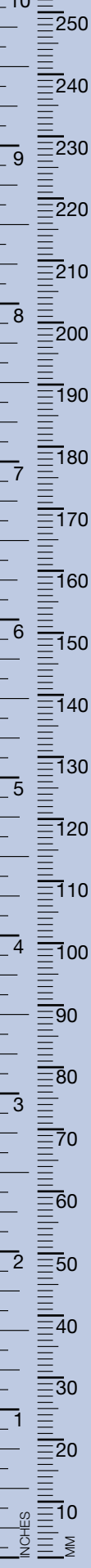

## RUSKIN BONE SPLITTING FORCEPS

Double-action. Overall length 7<sup>3</sup>/<sub>8</sub>" (18.7cm).

<u>Item Number</u>	<u>Description</u>
MDS3228618	Straight blades
MDS3228918	Angled blades



## TUDOR-EDWARDS COSTOTOME

<u>Item Number</u>	<u>Description</u>
MDS3230450	Overall length 9 <sup>1</sup> / <sub>4</sub> " (23.5cm)



## LISTON-STILLE-TYPE BONE CUTTING FORCEPS

Double-action bone cutting forceps.  
Overall length 10<sup>1</sup>/<sub>2</sub>" (26.7cm).

<u>Item Number</u>	<u>Description</u>
MDS3229027	Straight
MDS3229127	Curved

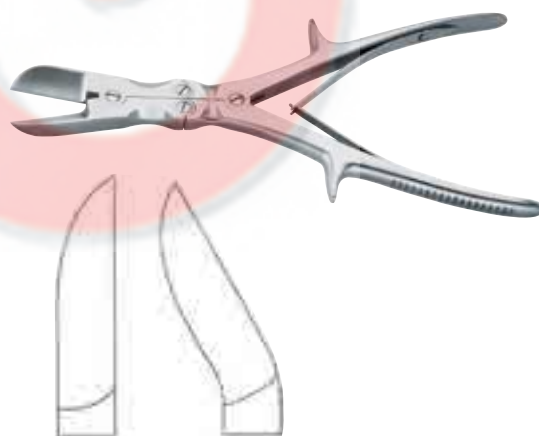

## HORSLEY BONE CUTTING FORCEPS

Double-action with double bend.

<u>Item Number</u>	<u>Description</u>
MDS3234720	Overall length 10" (25.4cm)



## SAUERBRUCH RIB RONGEUR FORCEPS

Double-action. Square jaws.  
Overall length 12" (30.5cm).

<u>Item Number</u>	<u>Description</u>
MDS3220560	Straight jaws, 14mm wide
MDS3220564	Straight jaws, 20mm wide
MDS3220584	Curved jaws, 20mm wide



## LEBSCHKE STERNUM KNIFE

<u>Item Number</u>	<u>Description</u>
MDS3267824	Overall length 10" (25.4cm)



## SAUERBRUCH RETRACTORS

Flat blade is slightly curved on end.  
Overall length 9½" (24.1cm).

<u>Item Number</u>	<u>Description</u>
MDS1849445	Blade 1¾" x 5⁄8" (4.4cm x 1.6cm) wide
MDS1849460	Blade 2¼" x 7⁄8" (5.7cm x 2.2cm) wide
MDS1849475	Blade 27⁄8" x ¾" (7.3cm x 1.9cm) wide



## SEMB LUNG RETRACTORS

Overall length 9¼" (24.8cm).

<u>Item Number</u>	<u>Description</u>
MDS1890830	Blade 1⅛" x ¾" (2.8cm x 1.9cm) wide
MDS1890832	Blade 1⅝" x 1" (4.1cm x 2.4cm) wide



## PARSONNET EPICARDIAL RETRACTORS

Self-retaining, light spring steel retractor with 3 x 3 sharp prongs.

Item Number	Description
MDS1830751	Overall length 1 1/4" (3.2cm)
MDS1830752	Overall length 1 1/2" (3.8cm)
MDS1830750	Overall length 2" (5.1cm)



## ROSS AORTIC VALVE RETRACTORS

Overall length 10" (25.4cm).

Item Number	Description
MDS1840501	No. 1 blade, 1.5cm x 1.6cm wide
MDS1840502	No. 2 blade, 1.3cm x 2.3cm wide
MDS1840503	No. 3 blade, 1.8mm x 2.5mm wide
MDS1840504	No. 4 blade, 1.3cm x 2.9cm wide
MDS1840505	No. 5 blade, 2.9cm x 2.9cm wide
MDS1840506	No. 6 blade, 3.5cm x 2.1cm wide



## CASTANEDA SUTURE TAG FORCEPS

Smooth jaw.

Item Number	Description
MDS1820805	Overall length 4" (10.2cm)

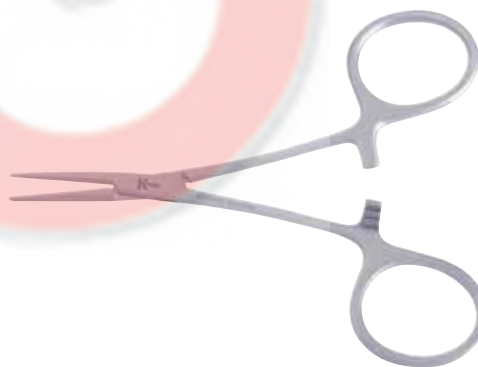

## FINOCHIETTO PEDIATRIC RIB SPREADER

Curved blade arms.

Item Number	Description
MDS5621016	Blades 1 1/4" x 1 3/4" (3.2cm x 4.4cm) wide, arm length 5 1/2" (14cm), spread 6" (15.2cm)



## FINOCHIETTO RIB SPREADERS

Aluminum arms and blades.

<u>Item Number</u>	<u>Description</u>
MDS5623475	Blades, 10mm x 15mm wide, arm length 2 <sup>3</sup> / <sub>4</sub> " (7cm), spread 2 <sup>3</sup> / <sub>4</sub> " (7cm)



## BURFORD RIB SPREADER

Aluminum arms and blades.

<u>Item Number</u>	<u>Description</u>
MDS5624413	Two blade sets: 1 <sup>1</sup> / <sub>4</sub> " x 1 <sup>1</sup> / <sub>8</sub> " (3.2cm x 2.9cm) wide and 1 <sup>3</sup> / <sub>4</sub> " x 1 <sup>1</sup> / <sub>8</sub> " (4.5cm x 2.9cm) wide, arm length 6" (15.2cm), spread 5 <sup>1</sup> / <sub>2</sub> " (14cm)



## COOLEY NEONATAL STERNAL RETRACTOR

Aluminum blades and arms.

<u>Item Number</u>	<u>Description</u>
MDS5627890	Blades <sup>3</sup> / <sub>8</sub> " x <sup>5</sup> / <sub>8</sub> " (10mm x 16mm) wide, arm length 2 <sup>1</sup> / <sub>8</sub> " (5.4cm), spread 3 <sup>1</sup> / <sub>8</sub> " (7.9cm)



## COOLEY STERNOTOMY RETRACTORS

Aluminum arms and blades.

<u>Item Number</u>	<u>Description</u>
MDS5627894	Blades 20mm x 29mm wide, arm length 3 <sup>1</sup> / <sub>8</sub> " (7.9cm), spread 4 <sup>5</sup> / <sub>8</sub> " (11.7cm)
MDS5627895	Blades 14mm x 16mm wide, arm length 2 <sup>3</sup> / <sub>4</sub> " (7cm), spread 3 <sup>3</sup> / <sub>8</sub> " (8.6cm)



## COOLEY STERNOTOMY RETRACTORS

Item Number	Description
MDS5610321	Blades, 1 <sup>3</sup> / <sub>8</sub> " x 2" (3.5cm x 5cm) wide, arm length 5 <sup>3</sup> / <sub>4</sub> " (14.5cm), spread 9 <sup>1</sup> / <sub>2</sub> " (24.2cm)
MDS5610322	Blades 7 <sup>7</sup> / <sub>8</sub> " x 1 <sup>7</sup> / <sub>8</sub> " (2.1cm x 4.6cm) wide, arm length 4 <sup>3</sup> / <sub>8</sub> " (11cm), spread 8 <sup>1</sup> / <sub>4</sub> " (21cm)



## IMA RETRACTOR SET

Item Number	Description
MDS5628050	Complete, spreading width: 230mm including: 1 Frame with arms (1-10-729-04) 1 Double fixation blade (1-10-729-09) 1 Double fixation blade with notch for fixation to T-track (1-10-729-07) 1 T-clamp (1-10-729-15) 2 Universal clamps (1-10-729-30) 2 COOLEY small blade retractors, 25mm (1-10-729-35) 1 COOLEY medium blade retractor, 40mm (1-10-729-40) 1 COOLEY large blade retractor, 50mm (1-10-729-45) 2 RIBBON malleable blades (1-10-729-50)



## TUFFIER RIB SPREADER

Item Number	Description
MDS5626416	Blades 1 <sup>1</sup> / <sub>2</sub> " x 1 <sup>5</sup> / <sub>8</sub> " (3.8cm x 4.1cm) wide, spread 7" (17.8cm)





## FINOCHIETTO RIB SPREADERS

Curved blade arms. Arm length 7<sup>1</sup>/<sub>4</sub>" (18.4cm).  
Spread 8<sup>1</sup>/<sub>2</sub>" (21.6cm).

<u>Item Number</u>	<u>Description</u>
MDS5621020	Adult, blades 1 <sup>3</sup> / <sub>4</sub> " x 2 <sup>1</sup> / <sub>2</sub> " (4.4cm x 6.4cm) wide
MDS5621025	Large, blades 2 <sup>3</sup> / <sub>4</sub> " x 2 <sup>1</sup> / <sub>2</sub> " (7cm x 6.4cm) wide



## BURFORD RIB SPREADER

<u>Item Number</u>	<u>Description</u>
MDS5624216	Two small blades 1 <sup>3</sup> / <sub>4</sub> " x 2 <sup>1</sup> / <sub>2</sub> " (4.4cm x 6.4cm) wide and two large blades 3" x 2 <sup>1</sup> / <sub>2</sub> " (7.6cm x 6.4cm) wide, spread 7 <sup>1</sup> / <sub>2</sub> " (19cm)



## BURFORD RIB SPREADER

Aluminum arms and blades.

<u>Item Number</u>	<u>Description</u>
MDS5624218	Adult, two blade set: 2" x 2 <sup>1</sup> / <sub>4</sub> " (5.1cm x 5.7cm) wide and 2 <sup>1</sup> / <sub>2</sub> " x 2 <sup>1</sup> / <sub>2</sub> " (6.4cm x 6.4cm) wide, arm length 9 <sup>5</sup> / <sub>16</sub> " (23.7cm), spread 7 <sup>7</sup> / <sub>8</sub> " (20cm)

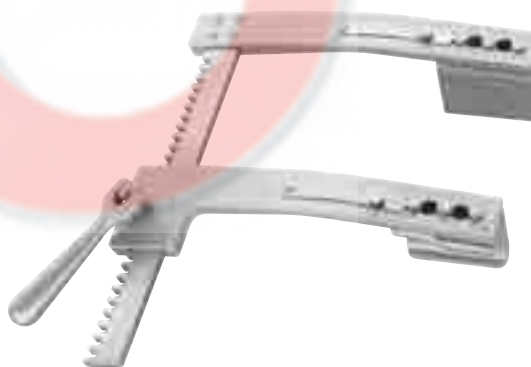

## TUFFIER RIB RETRACTOR

Total opening 6<sup>1</sup>/<sub>2</sub>" (16.5cm).

<u>Item Number</u>	<u>Description</u>
MDS5626417	Serrated blades 2" x 1 <sup>3</sup> / <sub>4</sub> " wide (5.1cm x 4.4cm), blades 2" deep (5.1cm)



## HENLY RETRACTORS

Original-type. Modified version of the Weitlaner retractor allows for a third retractor blade to be attached.

<u>Item Number</u>	<u>Description</u>
MDS1872302	Complete set includes henly retractor, overall length 6½" (16.5cm), and three center blades
MDS1872319	Small, ¾" x ⅝" wide (1.9cm x 1.6cm)
MDS1873625	Medium, 1" x ⅝" wide (2.5cm x 1.6cm)
MDS1872332	Large, 1¼" x ⅝" wide, (3.2cm x 1.6cm)



## CRILE HOOK AND DISSECTOR

<u>Item Number</u>	<u>Description</u>
MDS4092600	Overall length 12½" (31.8cm)



## ADSON BLUNT DISSECTING HOOK

Tip length 5mm.

<u>Item Number</u>	<u>Description</u>
MDS4006920	Overall length 8¼" (20.8cm)



## CRILE SINGLE HOOK

<u>Item Number</u>	<u>Description</u>
MDS4090220	Overall length 12½" (31.8cm)



## METZENBAUM DISSECTING SCISSORS

Curved. Blunt/blunt.

Item Number	Description
MDS0828128	Curved, blade length 2 <sup>1</sup> / <sub>2</sub> " (6.4cm) from mid-screw, overall length 11 <sup>3</sup> / <sub>16</sub> " (28.4cm)
MDS0828123	Curved, blade length 2" (5.1cm), overall length 9" (22.9cm)
MDS0828120	Curved, blade length 1 <sup>3</sup> / <sub>4</sub> " (4.4cm), overall length 8" (20.3cm)



## SUPER CUT METZENBAUM DISSECTING SCISSORS

Curved. Mirror finish. Black handles.

Item Number	Description
MDS0728123	Overall length 9" (22.9cm)

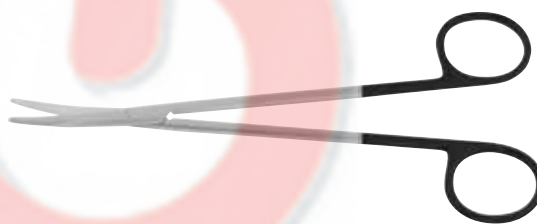

## JAMISON-METZENBAUM SCISSORS

Curved. Tenotomy type tips.

Item Number	Description
MDS0782623	Overall length 9" (22.9cm)



## CHURCH SCISSORS

Light, long scissors. Beveled, Mayo-type dissecting blades. Blunt.

<u>Item Number</u>	<u>Description</u>
MDS0816675	Straight, overall length 6 <sup>3</sup> / <sub>4</sub> " (17.1cm)
MDS0815675	Curved, overall length 6 <sup>3</sup> / <sub>4</sub> " (17.1cm)
MDS0816610	Curved, overall length 10" (25.4cm)
MDS0815610	Straight, overall length 10" (25.4cm)



## NELSON LOBECTOMY SCISSORS

Rounded, curved blades.

<u>Item Number</u>	<u>Description</u>
MDS4431910	Overall length 10 <sup>1</sup> / <sub>4</sub> " (26cm)
MDS4431914	Overall length 14 <sup>1</sup> / <sub>4</sub> " (36.2cm)

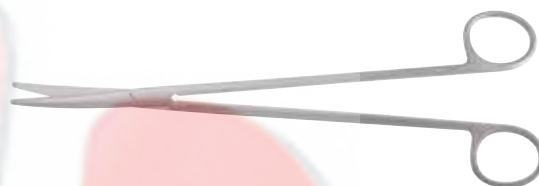

## COOLEY CARDIOVASCULAR "MY" SCISSORS

Mayo-type tips. Curved. Mirror finish.

<u>Item Number</u>	<u>Description</u>
MDS0801118	Overall length 7 <sup>1</sup> / <sub>2</sub> " (19cm)
MDS0801123	Overall length 9" (22.9cm)

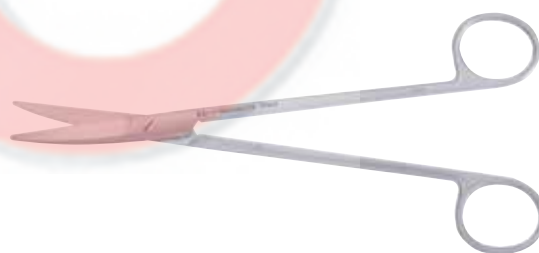

## CRAFOORD LOBECTOMY SCISSORS

Curved heavier blade. Blunt/blunt.

<u>Item Number</u>	<u>Description</u>
MDS0864130	Overall length 12" (30.5cm)



## JORGENSON SCISSORS

A modification of the Mayo dissecting scissors with an exaggerated curve. Mirror finish.

<u>Item Number</u>	<u>Description</u>
MDS0865022	Overall length 8½" (21.6cm)



## ARTERY SCISSORS

Ball tip on lower blades. Overall length 6¾" (17.2cm).

<u>Item Number</u>	<u>Description</u>
MDS0942325	Angled 25°
MDS0942345	Angled 45°
MDS0942360	Angled 60°
MDS0942390	Angled 90°
MDS0942312	Angled 120°

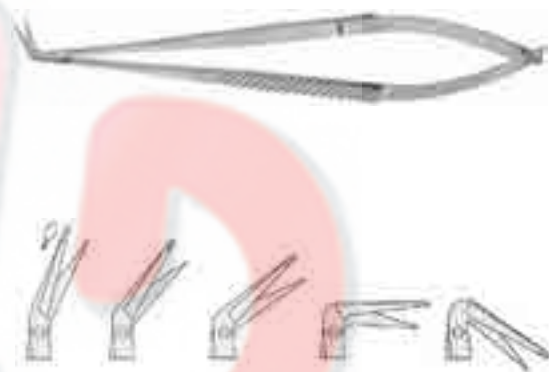

## ARTERY SCISSORS

Overall length 6¾" (17.2cm).

<u>Item Number</u>	<u>Description</u>
MDS0942125	Blades angled 25°
MDS0942145	Blades angled 45°
MDS0942160	Blades angled 60°
MDS0942190	Blades angled 90°
MDS0942112	Blades angled 120°

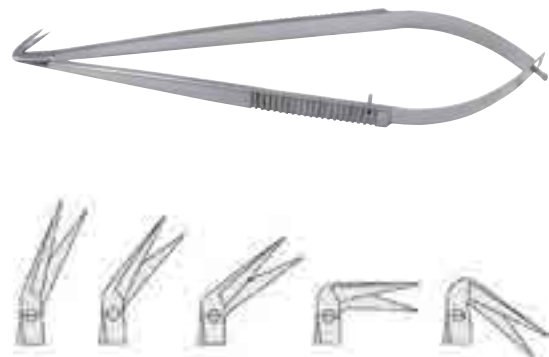

## CASTROVIEJO MICRO SCISSORS

Round handle. Sharp fine tips.  
Overall length 4½" (11.4cm).

Item Number	Description
MDS4431525	Angled 25°
MDS4431545	Angled 45°
MDS4431560	Angled 60°
MDS4431590	Angled 90°
MDS4431512	Angled 125°



## JACOBSON ANGLED SPRING-HANDLED SCISSORS

Round handle. Fine blades. Overall length 7" (17.8cm).

Item Number	Description
MDS4431325	Angled 25° sharp
MDS4431345	Angled 45° sharp
MDS4431360	Angled 60° sharp
MDS4431390	Angled 90° sharp
MDS4431312	Angled 125° sharp



## JACOBSON MICRO SCISSORS

Sharp fine tips. Overall length 7" (17.8cm).

Item Number	Description
MDS4431425	Blades angled 25°
MDS4431445	Blades angled 45°
MDS4431460	Blades angled 60°
MDS4431490	Blades angled 90°
MDS4431412	Blades angled 125°



## ARTERY SCISSORS

Fine. Overall length 8" (20.3cm).

Item Number	Description
MDS0849025	Blades angled 25°
MDS0849045	Blades angled 45°
MDS0849060	Blades angled 60°
MDS0849090	Blades angled 90°





## SATINSKY SCISSORS

Fully curved blades, slightly curved handle. Mirror finish.

<u>Item Number</u>	<u>Description</u>
MDS0865124	Blade length $1\frac{7}{8}$ " (4.8cm), overall length $9\frac{3}{4}$ " (24.8cm)

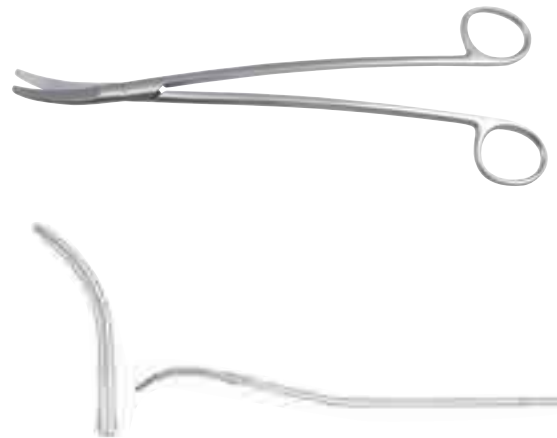

## POTTS-SMITH DISSECTING SCISSORS

Curved. Mirror finish.

<u>Item Number</u>	<u>Description</u>
MDS0804119	Overall length $7\frac{1}{2}$ " (19cm)

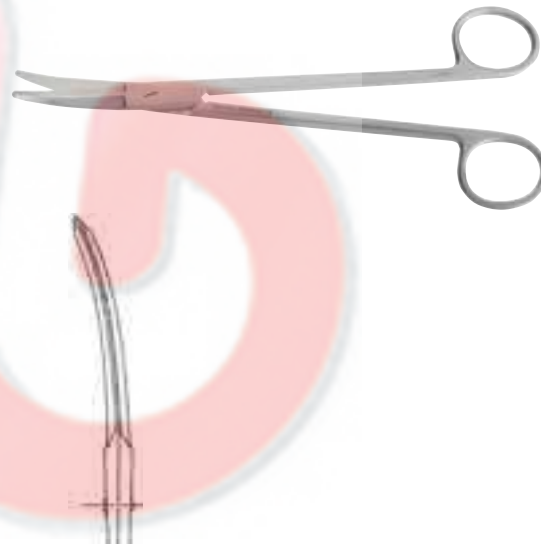

## DEBAKEY ENDARTERECTOMY SCISSORS

Mirror finish.

<u>Item Number</u>	<u>Description</u>
MDS9956918	Curved, blunt/blunt, overall length 7" (17.8cm)



## COOLEY ARTERIOTOMY SCISSORS

Blade angle 30°, length 1/2" (12mm). Mirror finish.

Item Number	Description
MDS4443019	Overall length 7 1/4" (18.4cm)
MDS4443023	Overall length 9" (22.9cm)
MDS4453027	Overall length 10 3/4" (27.3cm)

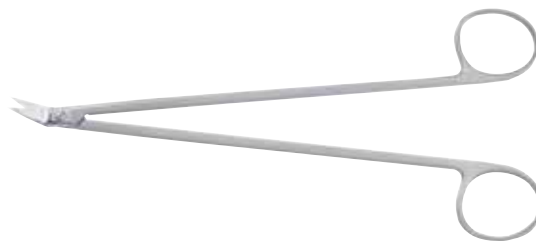

## FAVALORO CURVED SHANK CORONARY SCISSORS

Blades angled 130°.

Item Number	Description
MDS0896115	Blade length 7/16" (11mm), overall length 6 3/4" (17.1cm)



## DIETHRICH CORONARY ARTERY SCISSORS

Overall length 7" (17.8cm).

Item Number	Description
MDS0803025	Blades angled 25°
MDS0803045	Blades angled 45°
MDS0803060	Blades angled 60°
MDS0803090	Blades angled 90°
MDS0803012	Blades angled 125°, with stabilizer bar.

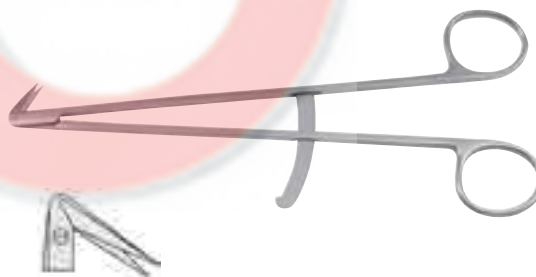

## DIETHRICH ARTERY SCISSORS

Extra fine blades. Overall length 7" (17.8cm).

Item Number	Description
MDS4432225	Blades angled 25°
MDS4432245	Blades angled 45°
MDS4432260	Blades angled 60°
MDS4432290	Blades angled 90°
MDS4432220	Blades angled 120°

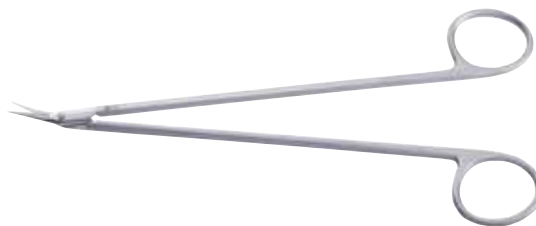

## POTTS-SMITH SCISSORS

Regular blades, length  $\frac{7}{8}$ " (22mm). Mirror finish.  
Overall length  $7\frac{1}{4}$ " (18.4cm).

<u>Item Number</u>	<u>Description</u>
--------------------	--------------------

MDS0848060	Angled 60°
------------	------------

MDS0848040	Angled 45°
------------	------------

MDS0848025	Angled 25°
------------	------------

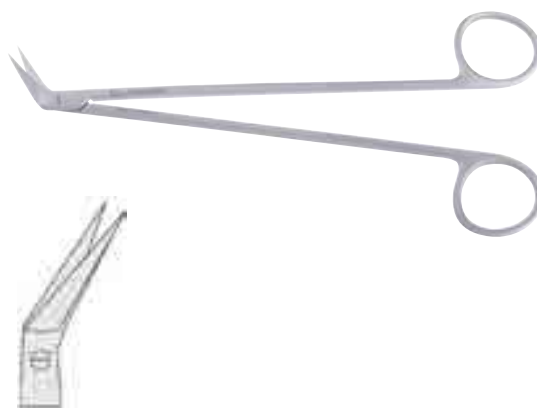

## POTTS-SMITH SCISSORS

Fine. Blade length  $\frac{1}{2}$ " (13mm).

<u>Item Number</u>	<u>Description</u>
--------------------	--------------------

MDS0858145	Angled 45°, overall length 7" (17.8cm)
------------	---

MDS0858125	Angled 25°, overall length $7\frac{1}{4}$ " (18.2cm)
------------	---

MDS0858160	Angled 60°, overall length 7" (17.8cm)
------------	---

MDS0858190	Angled 90°, overall length $6\frac{3}{4}$ " (17.1cm)
------------	---



## POTTS-SMITH SCISSORS

<u>Item Number</u>	<u>Description</u>
--------------------	--------------------

MDS0848345	Short, angled 45°, blade length $\frac{1}{2}$ " (1.3cm), overall length $5\frac{1}{4}$ " (13.3cm)
------------	---



## POTTS-SMITH SCISSORS

Blade length  $\frac{5}{8}$ " (1.5cm). Overall length 5" (12.7cm).

Item Number	Description
MDS0815625	Blades angled 25°
MDS0815660	Blades angled 60°
MDS0815690	Blades angled 90°



## DEBAKEY-POTTS SCISSORS

Blade length 1" (25mm). Mirror finish. Blunt/blunt.  
Overall length 6 $\frac{1}{2}$ " (16.5cm).

Item Number	Description
MDS0849016	Blades angled 25°
MDS0849116	Blades angled 45°
MDS0849216	Blades angled 60°



## POTTS-SMITH REVERSE SCISSORS

Blades angled 130°, length  $\frac{1}{2}$ " (1.3cm).  
Overall length 7" (17.8cm).

Item Number	Description
MDS0848130	With stabilizing bar
MDS0849130	Without stabilizing bar

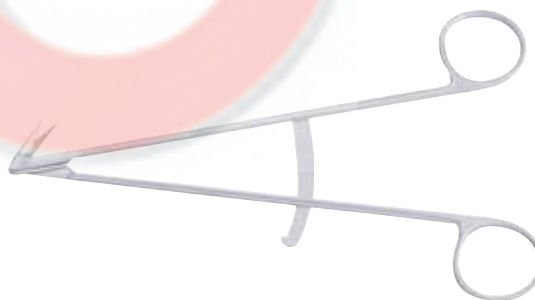

## SUPER CUT POTTS-SMITH SCISSORS

Black handles. Mirror finish. Overall length 7" (17.8cm).

Item Number	Description
MDS0849325	Angled 25°
MDS0849345	Angled 45°
MDS0849360	Angled 60°



## POTTS-TYPE ARTERY SCISSORS

Tapered shanks. Thin, narrow, micro blunt blades, 10mm.

<u>Item Number</u>	<u>Description</u>
MDS0867125	Angled 25°, overall length 7" (17.8cm)
MDS0867145	Angled 45°, overall length 7" (17.8cm)
MDS0867160	Angled 60°, overall length 6 <sup>7</sup> / <sub>8</sub> " (17.5cm)
MDS0867190	Angled 90°, overall length 6 <sup>3</sup> / <sub>4</sub> " (17.1cm)
MDS0867120	Angled 120°, overall length 6 <sup>3</sup> / <sub>4</sub> " (17.1cm)



## POTTS-REYNOLDS TENOTOMY SCISSORS

Curved, tapered blades. Mirror finish.

<u>Item Number</u>	<u>Description</u>
MDS0832115	Overall length 6" (15.2cm)
MDS0832118	Overall length 7" (17.8cm)

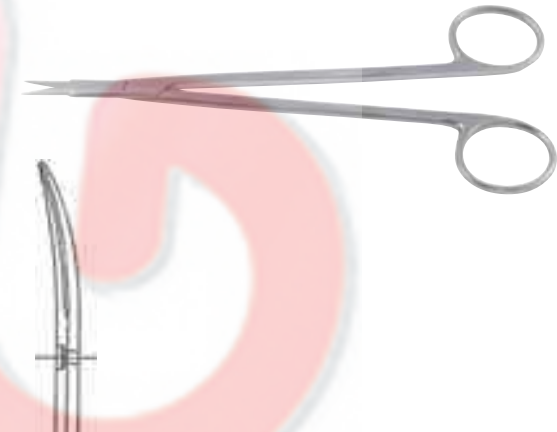

## DEBAKEY VASCULAR SCISSORS

Blade length 1" (25mm). Mirror finish.

<u>Item Number</u>	<u>Description</u>
MDS0849023	Blades angled 25°, overall length 9" (22.9cm)
MDS0849123	Blades angled 45°, overall length 9" (22.9cm)
MDS0849223	Blades angled 60°, overall length 9" (22.9cm)
MDS0849028	Blades angled 25°, overall length 11 <sup>1</sup> / <sub>4</sub> " (28.6cm)
MDS0849128	Blades angled 45°, overall length 11 <sup>1</sup> / <sub>4</sub> " (28.6cm)

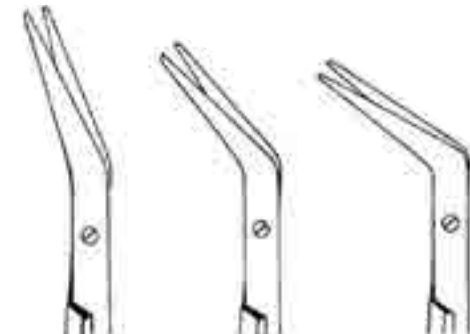

## POTTS TENOTOMY SCISSORS

Curved. Mirror finish.

<b>Item Number</b>	<b>Description</b>
MDS0832121	Overall length 8" (20.3cm)



## POTTS-SMITH DISSECTING SCISSORS

Curved. Mirror finish.

<b>Item Number</b>	<b>Description</b>
MDS0804129	Overall length 11 1/4" (28.6cm)
MDS0804123	Overall length 9" (22.9cm)
MDS0804119	Overall length 7 1/2" (19cm)
MDS0804114	Overall length 5 1/2" (14cm)



## LILEHEI-POTTS TENOTOMY SCISSORS

Overall length 7" (17.8cm).

<b>Item Number</b>	<b>Description</b>
MDS0801917	Straight
MDS0802017	Curved

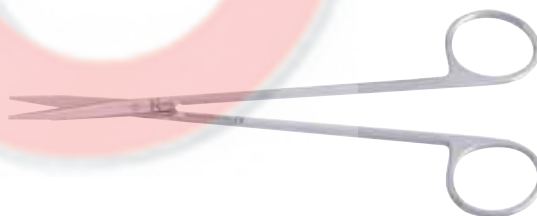

## TOENNIS DISSECTING SCISSORS

Fine. Mirror finish.

<b>Item Number</b>	<b>Description</b>
MDS0861018	Straight, overall length 7 1/4" (18.4cm)
MDS0861118	Curved, overall length 7 1/8" (18.1cm)

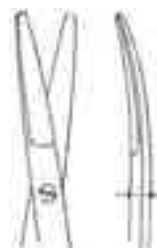

## CARDIOVASCULAR SCISSORS

Very fine and fine. Small ball tip on one blade. Straight. Mirror finish.

<u>Item Number</u>	<u>Description</u>
MDS0847011	Overall length 4 <sup>3</sup> / <sub>4</sub> " (12.1cm)



## DEMARTEL VASCULAR SCISSORS

Slim and fine. Blunt/blunt. Blade length from mid-screw 1<sup>1</sup>/<sub>8</sub>" (2.9cm). Mirror finish.

<u>Item Number</u>	<u>Description</u>
MDS0847118	Curved, overall length 7 <sup>3</sup> / <sub>4</sub> " (19.7cm)
MDS0847116	Curved, overall length 6 <sup>3</sup> / <sub>4</sub> " (17.1cm)
MDS0847018	Straight, overall length 7 <sup>3</sup> / <sub>4</sub> " (19.7cm)



## SATINSKY SCISSORS

Fully curved blades, slightly curved handle. Mirror finish.

<u>Item Number</u>	<u>Description</u>
MDS0865124	Blade length 1 <sup>7</sup> / <sub>8</sub> " (4.8cm), overall length 9 <sup>3</sup> / <sub>4</sub> " (24.8cm)

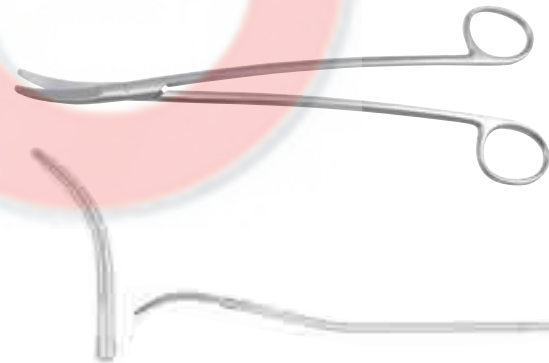

## DIETHRICH VALVE SCISSORS

Serrated blades. Overall length 9" (22.9cm).

<u>Item Number</u>	<u>Description</u>
MDS4432209	Slightly curved blades
MDS4432309	Fully curved blades

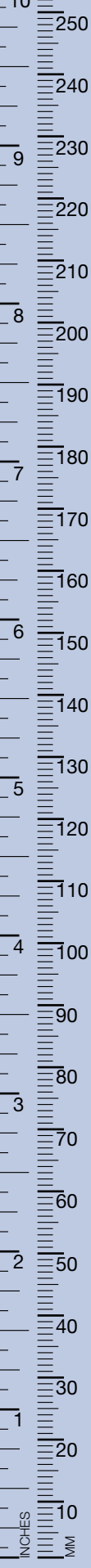



## COOLEY-BAUMGARTNER WIRE TWISTER

Tungsten carbide inserts

<u>Item Number</u>	<u>Description</u>
MDS2400020	Overall length 8" (20.3cm)



## BERRY STERNAL WIRE TWISTER

Heavy tungsten carbide jaws.

<u>Item Number</u>	<u>Description</u>
MDS2400040	Overall length 7 <sup>3</sup> / <sub>4</sub> " (19.7cm)



## SAROT NEEDLE HOLDERS

Indented shanks. Straight jaws.

<u>Item Number</u>	<u>Description</u>
MDS2432018	Overall length 7 <sup>1</sup> / <sub>8</sub> " (18.1cm)
MDS2432026	Overall length 10 <sup>1</sup> / <sub>4</sub> " (26cm)



## CRILE-MURRAY NEEDLE HOLDER

Straight, cross-serrated jaws.

<u>Item Number</u>	<u>Description</u>
MDS2417418	Overall length 7 <sup>1</sup> / <sub>4</sub> " (18.4cm)



## GRANT NEEDLE HOLDER

Straight jaws, combined with suture scissors.

<u>Item Number</u>	<u>Description</u>
MDS2442017	Overall length 6 $\frac{1}{2}$ " (16.5cm)



## WANGENSTEEN NEEDLE HOLDER

Straight jaw.

<u>Item Number</u>	<u>Description</u>
MDS2426027	Overall length 10 $\frac{3}{4}$ " (27.3cm)

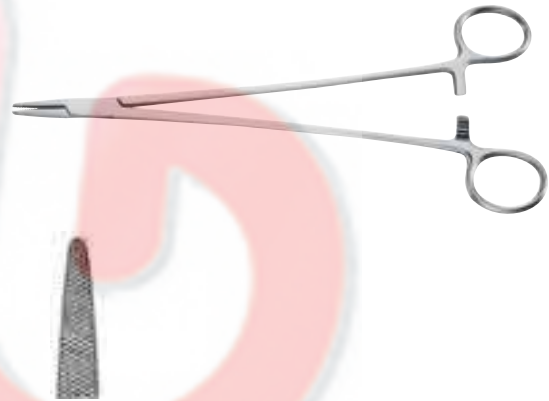

## MASSON NEEDLE HOLDER

<u>Item Number</u>	<u>Description</u>
MDS2425027	Overall length 10 $\frac{1}{2}$ " (26.7cm)



## ROCHESTER NEEDLE HOLDER

Light and fine. Straight jaws. Tungsten carbide inserts.  
3,600 teeth per square inch.

Item Number	Description
MDS2423418	Overall length 7 <sup>1</sup> / <sub>8</sub> " (18.1cm)

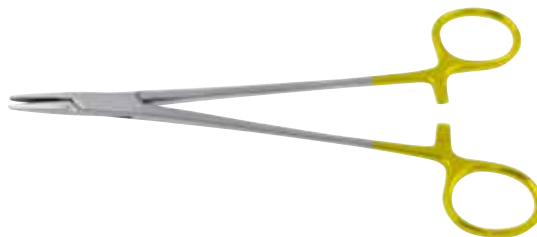

## COOLEY MICROVASCULAR NEEDLE HOLDERS

Very fine, straight jaws. Indented shanks.  
Tungsten carbide inserts.

Item Number	Description
MDS0651815	Smooth inserts, overall length 6" (15.2cm)
MDS0651817	Smooth inserts, overall length 6 <sup>3</sup> / <sub>4</sub> " (17.1cm)
MDS0651820	Smooth inserts, overall length 8" (20.3cm)
MDS0651915	Serrated inserts, 3,600 teeth per square inch, overall length 6" (15.2cm)
MDS0651917	Serrated inserts, 3,600 teeth per square inch, overall length 6 <sup>3</sup> / <sub>4</sub> " (17.1cm)
MDS0651920	Serrated inserts, 3,600 teeth per square inch, overall length 8" (20.3cm)

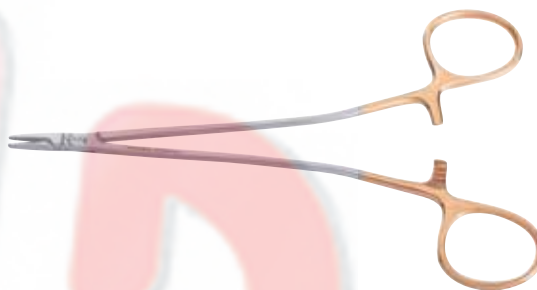

## COOLEY INTRACARDIAC NEEDLE HOLDERS

Straight, narrow jaw. Tungsten carbide inserts.  
3,600 teeth per square inch.

Item Number	Description
MDS2422418	Overall length 7" (17.8cm)
MDS2422420	Overall length 8" (20.3cm)
MDS2422423	Overall length 9" (22.9cm)
MDS2422426	Overall length 10 <sup>3</sup> / <sub>8</sub> " (26.3cm)

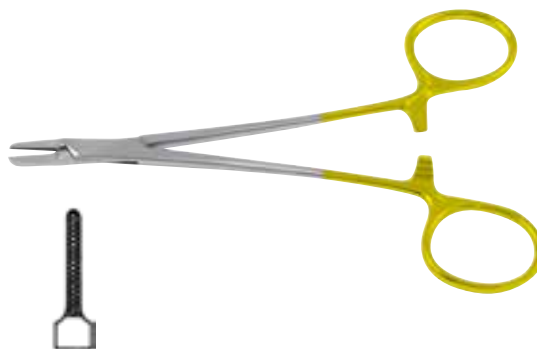

## MICROVASCULAR NEEDLE HOLDERS

Straight jaws, serrated. Tungsten carbide inserts.  
3,600 teeth per square inch.

<u>Item Number</u>	<u>Description</u>
MDS2442418	Overall length 7 <sup>1</sup> / <sub>8</sub> " (18.1cm)
MDS2442420	Overall length 8" (20.3cm)
MDS2442423	Overall length 9" (22.9cm)
MDS2442426	Overall length 10 <sup>1</sup> / <sub>4</sub> " (26cm)

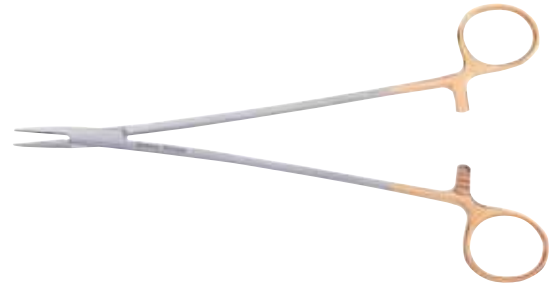

## RYDER NEEDLE HOLDERS

Narrow jaws. Tungsten carbide inserts.  
Gold plate.

<u>Item Number</u>	<u>Description</u>
MDS2422513	Smooth inserts, overall length 5" (12.7cm)
MDS2422515	Smooth inserts, overall length 6" (15.2cm)
MDS2422518	Smooth inserts, overall length 7" (17.8cm)
MDS2422520	Smooth inserts, overall length 8" (20.3cm)
MDS2422523	Smooth inserts, overall length 9" (22.9cm)
MDS2422213	Serrated inserts, 3,600 teeth per square inch, overall length 5" (12.7cm)
MDS2422215	Serrated inserts, 3,600 teeth per square inch, overall length 6" (15.2cm)
MDS2422218	Serrated inserts, 3,600 teeth per square inch, overall length 7" (17.8cm)
MDS2422220	Serrated inserts, 3,600 teeth per square inch, overall length 8" (20.3cm)
MDS2422223	Serrated inserts, 3,600 teeth per square inch, overall length 9" (22.9cm)

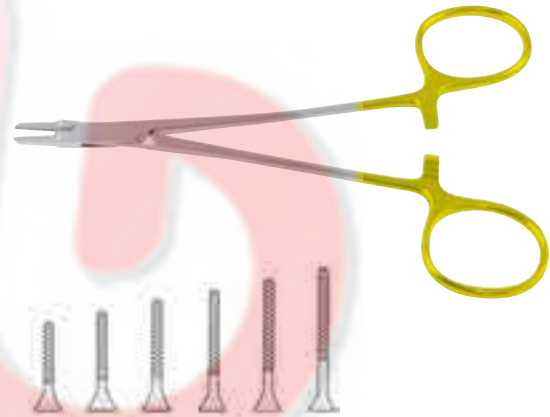

## CRILE-WOOD NEEDLE HOLDERS

Tungsten carbide inserts.

Item Number	Description
MDS2416615	Straight, smooth jaws, overall length 6" (15.2cm)
MDS2416318	Curved, serrated inserts, 3,600 teeth per square inch, overall length 7 <sup>1</sup> / <sub>8</sub> " (18.1cm)
MDS2416323	Curved, serrated inserts, 3,600 teeth per square inch, overall length 9 <sup>1</sup> / <sub>4</sub> " (23.5cm)
MDS2416418	Straight, serrated inserts, 3,600 teeth per square inch, overall length 7 <sup>1</sup> / <sub>8</sub> " (18.1cm)
MDS2416420	Straight, serrated inserts, 3,600 teeth per square inch, overall length 8" (20.3cm)
MDS2416423	Straight, serrated inserts, 3,600 teeth per square inch, overall length 9" (22.9cm)
MDS2416326	Straight, serrated inserts, 3,600 teeth per square inch, overall length 10 <sup>3</sup> / <sub>8</sub> " (26.3cm)
MDS2416430	Straight, serrated inserts, 3,600 teeth per square inch, overall length 11 <sup>3</sup> / <sub>4</sub> " (29.8cm)
MDS2416435	Straight, 3,600 teeth per square inch, overall length 14" (35.6cm)

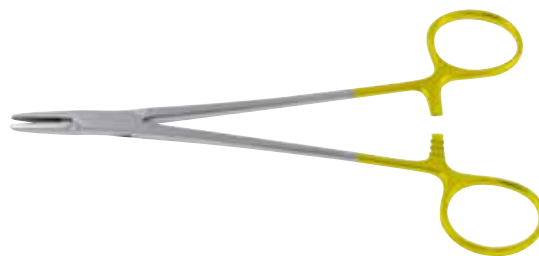

## DEBAKEY CARDIOVASCULAR NEEDLE HOLDERS

Fine pattern. Straight. Tungsten carbide inserts. 3,600 teeth per square inch.

Item Number	Description
MDS2421418	Overall length 7 <sup>1</sup> / <sub>8</sub> " (18.1cm)
MDS2421423	Overall length 9" (22.9cm)
MDS2421426	Overall length 10 <sup>3</sup> / <sub>8</sub> " (26.3cm)
MDS2421431	Overall length 11 <sup>3</sup> / <sub>4</sub> " (29.8cm)

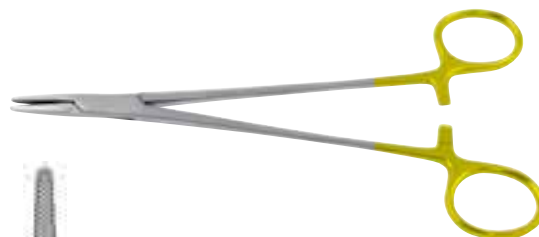

## DEBAKEY ULTRA LIGHT NEEDLE HOLDERS

Item Number	Description
MDS2421815	Overall length 6" (15.2cm)
MDS2421818	Overall length 7" (17.8cm)
MDS2421820	Overall length 8" (20.3cm)
MDS2421823	Overall length 9" (22.9cm)



## JULIAN NEEDLE HOLDERS

Light and fine. Tungsten carbide inserts.  
3,600 teeth per square inch.  
Overall length 8" (20.3cm).

Item Number	Description
MDS0652820	Straight jaws
MDS0652920	Curved jaws

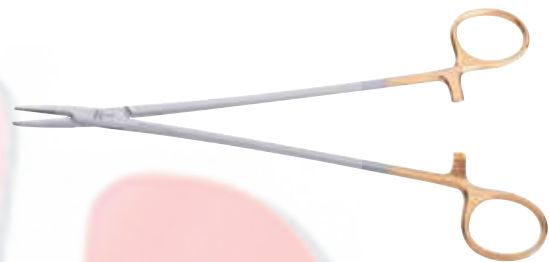

## SAROT NEEDLE HOLDERS

Tungsten carbide inserts. 3,600 teeth per square inch.

Item Number	Description
MDS2432418	Overall length 7" (17.8cm)

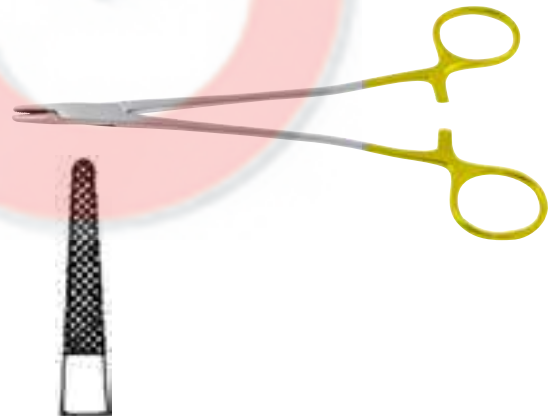

## MAYO-HEGAR NEEDLE HOLDERS

Tungsten carbide inserts. 2,500 teeth per square inch.

Item Number	Description
MDS2418430	Overall length 11 <sup>3</sup> / <sub>4</sub> " (29.8cm)
MDS2418435	Overall length 14" (35.6cm)



### MASSON NEEDLE HOLDER

Tungsten carbide inserts. 2,500 teeth per square inch.

Item Number	Description
MDS2425427	Overall length 10 $\frac{1}{4}$ " (26cm)



### WANGENSTEEN NEEDLE HOLDER

Straight jaws. Tungsten carbide inserts. 3,600 teeth per square inch.

Item Number	Description
MDS2426427	Overall length 10 $\frac{3}{4}$ " (27.3cm)

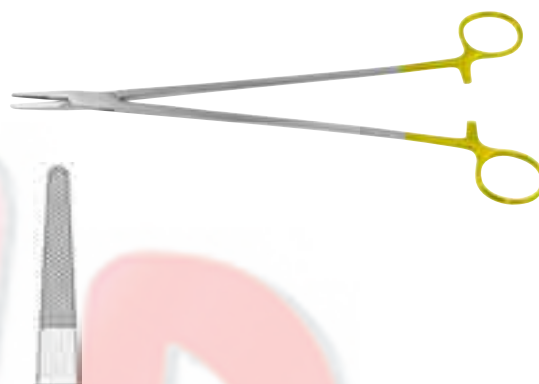

### STRATTE NEEDLE HOLDERS

Double bend, curved jaws. Tungsten carbide inserts. 3,600 teeth per square inch.

Item Number	Description
MDS2433423	Overall length 9" (22.9cm)

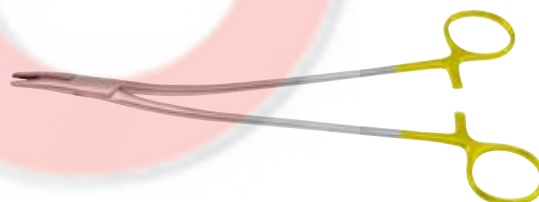

### MICROSURGERY NEEDLE HOLDERS

Spring handle. Smooth tungsten carbide inserts.

Item Number	Description
MDS2467514	Curved jaws, flat lock, overall length 5 $\frac{5}{8}$ " (14.3cm)
MDS2467814	Straight jaws, flat lock, overall length 5 $\frac{3}{4}$ " (14.6cm)
MDS2467414	Straight jaws, without lock, overall length 5 $\frac{3}{4}$ " (14.6cm)
MDS2467418	Straight jaws, flat lock, overall length 7 $\frac{1}{4}$ " (18.4cm)





## SPENCER CORONARY NEEDLE HOLDER

Spring handle. Flat lock. Smooth tungsten carbide inserts.

<u>Item Number</u>	<u>Description</u>
MDS0636579	Overall length 7" (17.8cm)



## CASTROVIEJO NEEDLE HOLDERS

Spring handle. Flat lock. Straight jaws.  
Tungsten carbide inserts. 3,600 teeth per square inch.

<u>Item Number</u>	<u>Description</u>
MDS2467618	Overall length 7 <sup>1</sup> / <sub>4</sub> " (18.4cm)
MDS2469521	Overall length 8 <sup>3</sup> / <sub>4</sub> " (22.2cm)



## JACOBSON HEAVY-STYLE NEEDLE HOLDERS

Round handle for large needles. Tungsten carbide inserts.  
3,600 teeth per square inch.

<u>Item Number</u>	<u>Description</u>
MDS2406310	Overall length 7 <sup>1</sup> / <sub>2</sub> " (19cm)
MDS2406330	Overall length 9" (22.9cm)
MDS2406340	Overall length 10" (25.4cm)



## JACOBSON NEEDLE HOLDERS

Spring handle. Round lock. Straight, smooth jaws.

<u>Item Number</u>	<u>Description</u>
MDS2429818	Overall length 7" (17.8cm)
MDS2429822	Overall length 8 <sup>3</sup> / <sub>4</sub> " (22.2cm)



## PRECISE TOUCH CASTROVIEJO MICRO NEEDLE HOLDERS

Round handle. Dusted jaws. Overall length 5<sup>3</sup>/<sub>4</sub>" (14.6cm).

Item Number	Description
MDS2420650	Straight, with lock
MDS2420652	Straight, without lock
MDS2420654	Curved, with lock
MDS2420656	Curved, without lock



## PRECISE TOUCH CASTROVIEJO MICRO NEEDLE HOLDERS

Flat handle. Dusted jaws. Overall length 5<sup>3</sup>/<sub>4</sub>" (14.6cm).

Item Number	Description
MDS2420658	Straight, with lock
MDS2420660	Straight, without lock
MDS2420662	Curved, with lock
MDS2420664	Curved, without lock

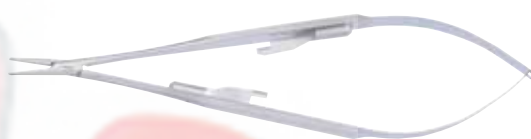

## PRECISE TOUCH JACOBSON MICRO NEEDLE HOLDERS

Flat handle. Dusted jaws.

Item Number	Description
MDS2420670	Straight, with lock, overall length 6 <sup>3</sup> / <sub>4</sub> " (17.1cm)
MDS2420672	Straight, without lock, overall length 6 <sup>3</sup> / <sub>4</sub> " (17.1cm)
MDS2420674	Curved, with lock, overall length 6 <sup>3</sup> / <sub>4</sub> " (17.1cm)
MDS2420676	Curved, without lock, overall length 6 <sup>3</sup> / <sub>4</sub> " (17.1cm)
MDS2420690	Straight, with lock, overall length 7 <sup>1</sup> / <sub>4</sub> " (18.4cm)
MDS2420692	Straight, without lock, overall length 7 <sup>1</sup> / <sub>4</sub> " (18.4cm)
MDS2420694	Curved, with lock, overall length 7 <sup>1</sup> / <sub>4</sub> " (18.4cm)
MDS2420696	Curved, without lock, overall length 7 <sup>1</sup> / <sub>4</sub> " (18.4cm)



## PRECISE TOUCH JACOBSON MICRO NEEDLE HOLDERS

Round handle. Dusted jaws.

Item Number	Description
MDS2406121	Straight, with lock, overall length 8 $\frac{1}{4}$ " (21cm)
MDS2406123	Straight, without lock, overall length 8 $\frac{1}{4}$ " (21cm)
MDS2406125	Curved, with lock, overall length 8 $\frac{1}{4}$ " (21cm)
MDS2406127	Curved, without lock, overall length 8 $\frac{1}{4}$ " (21cm)
MDS2420682	Straight, with lock, overall length 7 $\frac{1}{4}$ " (18.4cm)
MDS2420684	Straight, without lock, overall length 7 $\frac{1}{4}$ " (18.4cm)
MDS2420686	Curved, with lock, overall length 7 $\frac{1}{4}$ " (18.4cm)
MDS2420688	Curved without lock, overall length 7 $\frac{1}{4}$ " (18.4cm)



## PRECISE TOUCH JACOBSON MICRO NEEDLE HOLDERS

Round handle. Spiral cut. Dusted jaws.  
Overall length 8 $\frac{1}{4}$ " (21cm).

Item Number	Description
MDS2406120	Straight, with lock
MDS2406122	Straight, without lock
MDS2406124	Curved, with lock
MDS2406126	Curved, without lock



## PRECISE TOUCH JACOBSON MICRO NEEDLE HOLDERS

Short, round handle. Dusted jaws.  
Overall length 9" (22.9cm).

Item Number	Description
MDS2406128	Straight, with lock
MDS2406130	Straight, without lock
MDS2406132	Curved, with lock
MDS2406134	Curved, without lock



## PRECISE TOUCH JACOBSON MICRO NEEDLE HOLDERS

Flat handle. Dusted jaws.

<b>Item Number</b>	<b>Description</b>
MDS2406108	Straight, with lock, overall length 8½" (21.6cm)
MDS2406110	Straight, without lock, overall length 8½" (21.6cm)
MDS2406112	Curved, with lock, overall length 8½" (21.6cm)
MDS2406114	Curved, without lock, overall length 8½" (21.6cm)
MDS2406158	Straight, with lock, overall length 9½" (24.1cm)
MDS2406159	Straight, without lock, overall length 9½" (24.1cm)
MDS2406160	Curved, with lock, overall length 9½" (24.1cm)
MDS2406161	Curved, without lock, overall length 9½" (24.1cm)



## PRECISE TOUCH JACOBSON MICRO NEEDLE HOLDERS

Dusted jaw surface for use with 5-0 suture and smaller.  
Straight. Overall length 8" (20.3cm). Flat, knurled handle.

<b>Item Number</b>	<b>Description</b>
MDS2406100	With lock
MDS2406102	Without lock



## PRECISE TOUCH CASTROVIEJO NEEDLE HOLDERS

Dusted jaw surface for use with 6-0 to 8-0 suture.  
With lock.

<b>Item Number</b>	<b>Description</b>
MDS2401310	Straight, overall length 10" (25.4cm)
MDS2401410	Curved, overall length 10" (25.4cm)
MDS2421312	Straight, overall length 12" (30.5cm)
MDS2401412	Curved, overall length 12" (30.5cm)



## TITANIUM PRECISE TOUCH JACOBSON MICRO NEEDLE HOLDERS

Round handle. Dusted jaws.

<u>Item Number</u>	<u>Description</u>
MDS2403170	Straight, with lock, overall length 7 <sup>1</sup> / <sub>4</sub> " (18.4cm)
MDS2403172	Straight, without lock, overall length 7 <sup>1</sup> / <sub>4</sub> " (18.4cm)
MDS2403174	Curved, with lock, overall length 7 <sup>1</sup> / <sub>4</sub> " (18.4cm)
MDS2403176	Curved, without lock, overall length 7 <sup>1</sup> / <sub>4</sub> " (18.4cm)
MDS2403180	Straight, with lock, overall length 8" (20.3cm)
MDS2403182	Straight, without lock, overall length 8" (20.3cm)
MDS2403184	Curved, with lock, overall length 8" (20.3cm)
MDS2403186	Curved, without lock, overall length 8" (20.3cm)

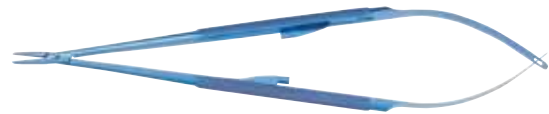

## TITANIUM PRECISE TOUCH JACOBSON MICRO NEEDLE HOLDERS

Flat handle. Dusted jaws.

<u>Item Number</u>	<u>Description</u>
MDS2403224	Straight, with lock, overall length 7 <sup>1</sup> / <sub>4</sub> " (18.4cm)
MDS2403226	Straight, without lock, overall length 7 <sup>1</sup> / <sub>4</sub> " (18.4cm)
MDS2403228	Curved, with lock, overall length 7 <sup>1</sup> / <sub>4</sub> " (18.4cm)
MDS2403230	Curved, without lock, overall length 7 <sup>1</sup> / <sub>4</sub> " (18.4cm)
MDS2403234	Straight, with lock, overall length 8 <sup>1</sup> / <sub>2</sub> " (21.6cm)
MDS2403236	Curved, without lock, overall length 8 <sup>1</sup> / <sub>2</sub> " (21.6cm)



## PRECISE TOUCH MICRO RING-HANDLED NEEDLE HOLDERS

<b>Item Number</b>	<b>Description</b>
MDS2420620	Straight jaws, overall length 5" (12.7cm)
MDS2420624	Straight jaws, overall length 5 <sup>3</sup> / <sub>4</sub> " (14.6cm)
MDS2420628	Straight jaws, overall length 6 <sup>1</sup> / <sub>4</sub> " (15.9cm)
MDS2420632	Straight jaws, overall length 7 <sup>1</sup> / <sub>4</sub> " (18.4cm)
MDS2420636	Straight jaws, overall length 8 <sup>1</sup> / <sub>2</sub> " (21.6cm)
MDS2420640	Straight jaws, overall length 10" (25.4cm)
MDS2420630	Curved jaws, overall length 6 <sup>1</sup> / <sub>4</sub> " (15.9cm)
MDS2420634	Curved jaws, overall length 7 <sup>1</sup> / <sub>4</sub> " (18.4cm)
MDS2420638	Curved jaws, overall length 8 <sup>3</sup> / <sub>4</sub> " (22.2cm)
MDS2420642	Curved jaws, overall length 10" (25.4cm)



## PRECISE TOUCH JACOBSON RING- HANDLED MICRO NEEDLE HOLDERS

With lock.

<b>Item Number</b>	<b>Description</b>
MDS2406148	Overall length 7 <sup>1</sup> / <sub>4</sub> " (18.4cm)
MDS2406150	Overall length 8" (20.3cm)
MDS2406152	Overall length 9" (22.9cm)



## JACOBSON DRESSING FORCEPS

Smooth jaws.

<b>Item Number</b>	<b>Description</b>
MDS1208515	Thin handle, overall length 4" (10.2cm)
MDS1208520	Broad handle, overall length 4 <sup>3</sup> / <sub>4</sub> " (12.1cm)



## POTTS-SMITH DRESSING FORCEPS

Fine, serrated tips.

<u>Item Number</u>	<u>Description</u>
MDS1011218	Overall length 7" (17.8cm)
MDS1011221	Overall length 8 <sup>1</sup> / <sub>4</sub> " (21cm)
MDS1011224	Overall length 9 <sup>1</sup> / <sub>2</sub> " (24.1cm)
MDS1011230	Overall length 12" (30.5cm)
MDS1011235	Overall length 14" (35.6cm)



## POTTS-SMITH TISSUE FORCEPS

Fine, serrated tips. 1 x 2 teeth.

<u>Item Number</u>	<u>Description</u>
MDS1012618	Overall length 7" (17.8cm)
MDS1012621	Overall length 8 <sup>1</sup> / <sub>4</sub> " (21cm)
MDS1012624	Overall length 9 <sup>1</sup> / <sub>2</sub> " (24.1cm)
MDS1012625	Overall length 10 <sup>1</sup> / <sub>4</sub> " (26cm)
MDS1012630	Overall length 12" (30.5cm)
MDS1012635	Overall length 14" (35.6cm)



## KANTROWITZ DRESSING FORCEPS

Curved, serrated tips. Angled jaws.

<u>Item Number</u>	<u>Description</u>
MDS1019325	Overall length 9 <sup>3</sup> / <sub>4</sub> " (24.8cm)

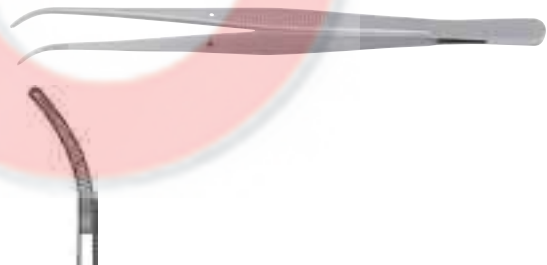

## GERALD FORCEPS

Straight. Flat handle.

<u>Item Number</u>	<u>Description</u>
MDS1200476	Serrated tips, 1mm wide, overall length 7" (17.8cm)
MDS1200477	Cross-serrated tips, 1mm wide, overall length 7 <sup>3</sup> / <sub>4</sub> " (19.7cm)
MDS1200479	Cross-serrated tips, 1mm wide, overall length 10" (25.4cm)
MDS12047912	Cross-serrated tips, 1.5mm wide, overall length 12" (30.5cm)





## PRECISE TOUCH GERALD-DEBAKEY FORCEPS

Straight. Flat handle. 1mm wide DeBakey tips.

Item Number	Description
MDS1203740	Overall length 7" (17.8cm)
MDS1203742	Overall length 8" (20.3cm)



## NELSON LUNG TISSUE FORCEPS

Item Number	Description
MDS1032223	6 x 7 teeth, overall length 9" (22.9cm)



## MAYO-RUSSIAN TISSUE FORCEPS

Rugged, non-perforating teeth surround the perforated jaws. Deeply serrated handles.

Item Number	Description
MDS1025735	Overall length 14" (35.6cm)



## DEBAKEY MICRO FORCEPS

Round handle. Tips 1.2mm wide.

Item Number	Description
MDS1201417	Overall length 6 <sup>3</sup> / <sub>4</sub> " (17.1cm)
MDS1201421	Overall length 8 <sup>1</sup> / <sub>4</sub> " (21cm)



## RESANO-TYPE FORCEPS

<u>Item Number</u>	<u>Description</u>
MDS1145918	Overall length 7" (17.8cm)
MDS1145923	Overall length 9" (22.9cm)
MDS1145927	Overall length 10 <sup>1</sup> / <sub>4</sub> " (26cm)



## DEBAKEY-DIETHRICH VASCULAR TISSUE FORCEPS

Extra-fine tips, 1mm wide.

<u>Item Number</u>	<u>Description</u>
MDS1131615	Overall length 6" (15.2cm)
MDS1131620	Overall length 7 <sup>3</sup> / <sub>4</sub> " (19.7cm)
MDS1131624	Overall length 9 <sup>1</sup> / <sub>2</sub> " (24.1cm)
MDS1131615T	Titanium, overall length 6" (15.2cm)
MDS1131620T	Titanium, overall length 7 <sup>3</sup> / <sub>4</sub> " (19.7cm)
MDS1131624T	Titanium, overall length 9 <sup>1</sup> / <sub>2</sub> " (24.1cm)



## DEBAKEY VASCULAR TISSUE FORCEPS

Fine jaws. Tips 1.5mm wide.

<u>Item Number</u>	<u>Description</u>
MDS1130616	Overall length 6" (15.2cm)
MDS1130620	Overall length 7 <sup>3</sup> / <sub>4</sub> " (19.7cm)
MDS1130624	Overall length 9 <sup>1</sup> / <sub>2</sub> " (24.1cm)
MDS1130630	Overall length 12" (30.5cm)

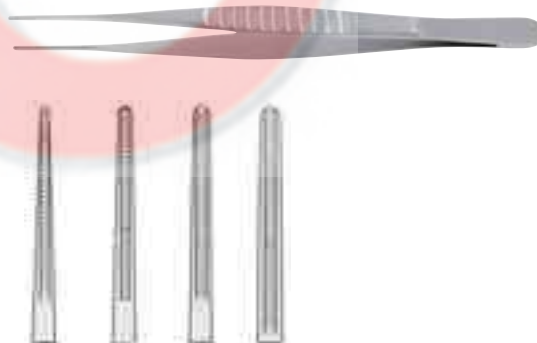

## DEBAKEY VASCULAR TISSUE FORCEPS

<u>Item Number</u>	<u>Description</u>
MDS1130816	Standard, overall length 6 <sup>1</sup> / <sub>4</sub> " (15.9cm)
MDS1130820	Standard, overall length 7 <sup>3</sup> / <sub>4</sub> " (19.7cm)
MDS1130824	Standard, overall length 9 <sup>1</sup> / <sub>2</sub> " (24.1cm)
MDS1130816T	Titanium, overall length 6 <sup>1</sup> / <sub>4</sub> " (15.9cm)
MDS1130820T	Titanium, overall length 7 <sup>3</sup> / <sub>4</sub> " (19.7cm)
MDS1130824T	Titanium, overall length 9 <sup>1</sup> / <sub>2</sub> " (24.1cm)



## DEBAKEY VASCULAR TISSUE FORCEPS

Heavy jaws taper from 2.5mm wide.

Item Number	Description
MDS1130416	Overall length 6 <sup>1</sup> / <sub>4</sub> " (15.9cm)
MDS1130420	Overall length 7 <sup>3</sup> / <sub>4</sub> " (19.7cm)
MDS1130424	Overall length 9 <sup>1</sup> / <sub>2</sub> " (24.1cm)



## DEBAKEY TISSUE FORCEPS

Item Number	Description
MDS1130830	Jaws 2mm wide, overall length 12" (30.5cm)
MDS1130835	Jaws 2mm wide, overall length 14" (35.6cm)
MDS1131835	Jaws 3mm wide, overall length 14" (35.6cm)
MDS1130840	Jaws 2mm wide, overall length 16" (40.6cm)
MDS1131840	Jaws 3mm wide, overall length 16" (40.6cm)



## DEBAKEY TISSUE FORCEPS

Straight. Fluted handle. Overall length 7<sup>3</sup>/<sub>4</sub>" (19.7cm).

Item Number	Description
MDS1200444	1mm tips
MDS1220446	2mm tips



## DEBAKEY VASCULAR TISSUE FORCEPS

Angled. Jaws taper from 2mm.

Item Number	Description
MDS1130916	Overall length 6" (15.2cm)
MDS1130920	Overall length 7 <sup>3</sup> / <sub>4</sub> " (19.7cm)
MDS1130924	Overall length 9 <sup>1</sup> / <sub>2</sub> " (24.1cm)
MDS1130925	Overall length 10" (25.4cm)



## DEBAKEY MICRO TISSUE FORCEPS

Lightweight. Round handle. Tips 1mm wide.

<u>Item Number</u>	<u>Description</u>
MDS1204230	Overall length 7 <sup>1</sup> / <sub>8</sub> " (18.1cm)
MDS1204232	Overall length 8 <sup>1</sup> / <sub>4</sub> " (21cm)



## COOLEY VASCULAR TISSUE FORCEPS

Jaws have cross serrations for fine work, 1mm wide.

<u>Item Number</u>	<u>Description</u>
MDS1132416	Overall length 8" (20.3cm)



## COOLEY VASCULAR TISSUE FORCEPS

Cooley jaws.

<u>Item Number</u>	<u>Description</u>
MDS1131416	Jaws 1.5mm wide, overall length 6" (15.3cm)
MDS1131420	Jaws 2mm wide, overall length 7 <sup>3</sup> / <sub>4</sub> " (19.7cm)
MDS1131224	Jaws 2.3mm wide, overall length 9 <sup>1</sup> / <sub>2</sub> " (24.1cm)



## SELMAN TISSUE FORCEPS

Fine, serrated, round tips.

<u>Item Number</u>	<u>Description</u>
MDS1060215	Overall length 6" (15.2cm)
MDS1060220	Overall length 8" (20.3cm)
MDS1060226	Overall length 10" (25.4cm)



## PRECISE TOUCH MICRO FORCEPS

Lightweight. 1 x 2 teeth. Round handle.  
Platform tips, 0.8mm wide.



Item Number	Description
MDS1204235	Overall length 7 <sup>1</sup> / <sub>8</sub> " (18.1cm)

## PRECISE TOUCH MICRO FORCEPS

Round handle. Straight. 1mm ring tips.



Item Number	Description
MDS1204216	Overall length 6" (15.2cm)
MDS1204220	Overall length 7 <sup>1</sup> / <sub>4</sub> " (18.4cm)
MDS1204224	Overall length 8 <sup>1</sup> / <sub>4</sub> " (21cm)
MDS1204226	Overall length 9" (22.9cm)
MDS1204228	Overall length 10" (25.4cm)

## PRECISE TOUCH DENNIS MICRO FORCEPS

Round handle. 2mm ring tips. Straight.

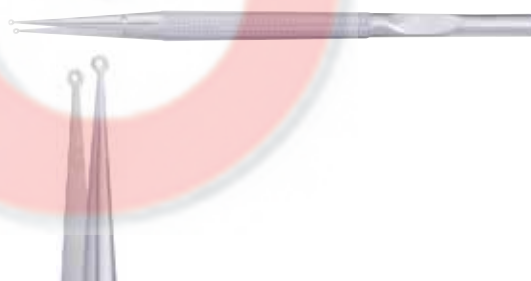

Item Number	Description
MDS1204320	Overall length 7" (17.8cm)

## PRECISE TOUCH MICRO FORCEPS

Lightweight. Straight. Round handle.



Item Number	Description
MDS1204250	1mm ring tips, overall length 7 <sup>1</sup> / <sub>8</sub> " (18.1cm)
MDS1204252	1mm ring tips, overall length 8 <sup>1</sup> / <sub>4</sub> " (21cm)
MDS1204254	2.5mm ring tips, overall length 7 <sup>1</sup> / <sub>8</sub> " (18.1cm)
MDS1204256	2.5mm ring tips, overall length 8 <sup>1</sup> / <sub>4</sub> " (21cm)

## PRECISE TOUCH GERALD FORCEPS

Straight. Flat handle.

<u>Item Number</u>	<u>Description</u>
MDS1204246	1mm tips, overall length 7" (17.8cm)
MDS1204248	1mm tips, overall length 8" (20.3cm)
MDS1204249	1mm tips, overall length 9" (22.9cm)
MDS1204346	1mm platform tips, overall length 7" (17.8cm)



## PRECISE TOUCH MICRO FORCEPS

Round handle.

<u>Item Number</u>	<u>Description</u>
MDS1204204	Straight, platform tips, 0.9mm wide, overall length 10" (25.4cm).
MDS1204206	Curved, platform tips, 0.8mm wide, overall length 10" (25.4cm)
MDS1200495	Straight, platform tips, 0.9mm wide, overall length 7 <sup>1</sup> / <sub>8</sub> " (18.1cm)
MDS1200496	Curved, platform tips, 0.8mm wide, overall length 7 <sup>1</sup> / <sub>8</sub> " (18.1cm)
MDS1200498	Straight, platform tips, 0.9mm wide, overall length 8 <sup>1</sup> / <sub>4</sub> " (21cm)
MDS1200499	Curved, platform tips, 0.8mm wide, overall length 8 <sup>1</sup> / <sub>4</sub> " (21cm)

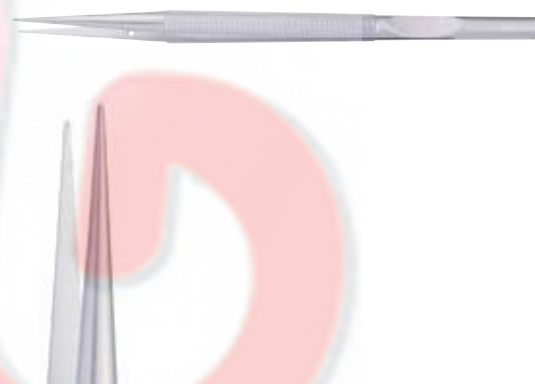

## PRECISE TOUCH MICRO FORCEPS

Lightweight. Straight. 1mm platform ring tips.  
Round handle.

<u>Item Number</u>	<u>Description</u>
MDS1204280	Overall length 7 <sup>1</sup> / <sub>8</sub> " (18.1cm)
MDS1204282	Overall length 8 <sup>1</sup> / <sub>4</sub> " (21cm)



## LERICHE HEMOSTATIC FORCEPS

Serrated jaws. Overall length 6" (15.2cm).

Item Number	Description
MDS1238015	Fine, straight
MDS1238115	Fine, curved
MDS1238215	Straight, 1 x 2 teeth



## JACOBSON MOSQUITO FORCEPS

Very fine. Overall length 5" (12.7cm).

Item Number	Description
MDS1229318	Straight jaws
MDS1229418	Curved jaws



## JACOBSON HEMOSTATIC FORCEPS

Very fine. Serrated jaws.

Item Number	Description
MDS1229518	Slightly curved, overall length 7 <sup>1</sup> / <sub>8</sub> " (18.1cm)
MDS1229718	Fully curved, overall length 7 <sup>1</sup> / <sub>8</sub> " (18.1cm)

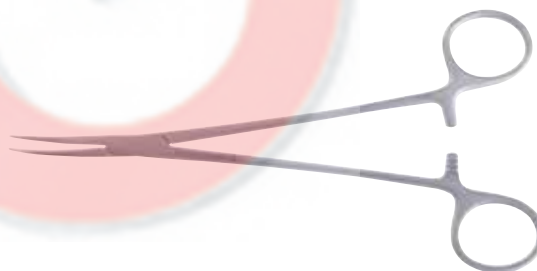

## BAILEY FORCEPS

Very fine, serrated jaws. Overall Length 7" (18cm).

Item Number	Description
MDS1229930	30 degrees
MDS1229960	60 degrees
MDS1229990	90 degrees





## CRILE-TYPE CLAMPS

Fine. Serrated jaws, length 1½" (3.8cm).  
Overall length 7½" (19cm).

<u>Item Number</u>	<u>Description</u>
MDS1242019	Straight
MDS1242119	Curved



## VANDERBILT DEEP VESSEL FORCEPS

Slender, curved, serrated jaws.

<u>Item Number</u>	<u>Description</u>
MDS1244721	Jaw length 1¾" (4.4cm), overall length 8½" (21.6cm)



## CRAFOORD-COLLIER CLAMPS

Curved. Fine.

<u>Item Number</u>	<u>Description</u>
MDS1245318	Overall length 7¼" (18.4cm)
MDS1245321	Overall length 9½" (24.4cm)

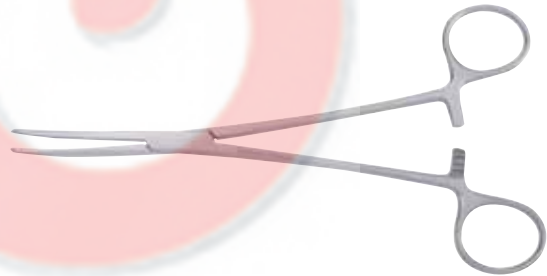

## RUMEL THORACIC ARTERY FORCEPS

Overall length 9¼" (24cm).

<u>Item Number</u>	<u>Description</u>
MDS1244101	Slightly curved jaws
MDS1244102	Curved jaws
MDS1244103	Fully curved jaws
MDS1244104	Angled jaws

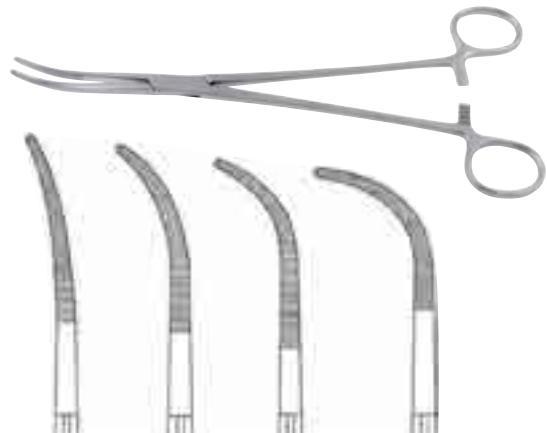

**JULIAN THORACIC ARTERY FORCEPS**

Slightly curved, serrated jaws, length 24mm.

<b>Item Number</b>	<b>Description</b>
MDS1244524	Overall length 9 <sup>1</sup> / <sub>4</sub> " (23.5cm)

**SAROT INTRATHORACIC ARTERY FORCEPS**

Serrated.

<b>Item Number</b>	<b>Description</b>
MDS1245024	Straight jaws, length 3" (7.6cm), overall length 9 <sup>1</sup> / <sub>2</sub> " (24.1cm)
MDS1245124	Curved jaws, length 3" (7.6cm), overall length 9 <sup>1</sup> / <sub>2</sub> " (24.1cm)
MDS1245125	Curved jaws, length 2 <sup>1</sup> / <sub>4</sub> " (5.7cm), overall length 9 <sup>3</sup> / <sub>4</sub> " (24.8cm)

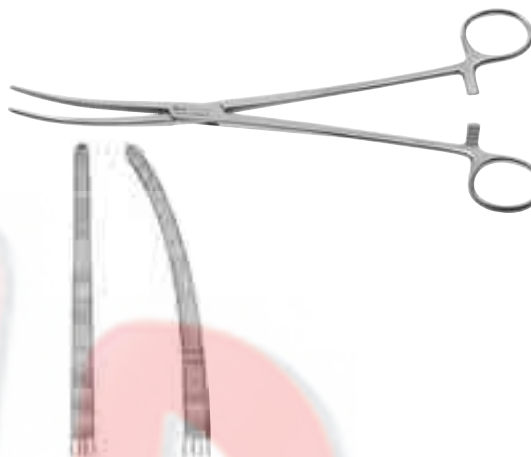
**WOODWARD THORACIC ARTERY FORCEPS**

Slightly curved jaws, length 32mm.

<b>Item Number</b>	<b>Description</b>
MDS1246122	Overall length 8 <sup>3</sup> / <sub>4</sub> " (22.2cm)

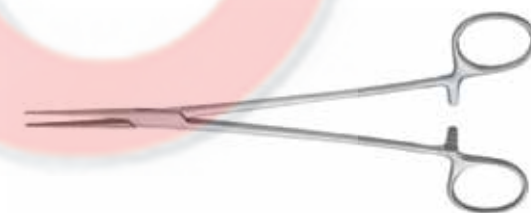
**CRAFOORD ARTERY FORCEPS**

Curved jaws.

<b>Item Number</b>	<b>Description</b>
MDS1245324	Overall length 9 <sup>1</sup> / <sub>2</sub> " (24cm)



## BRIDGE DEEP SURGERY FORCEPS

Serrated. Overall length 11" (27.9cm).

Item Number	Description
MDS1246028	Straight jaws, length 39mm
MDS1246128	Curved jaws, length 36.5mm
MDS1246228	Fine, curved jaws, length 32mm

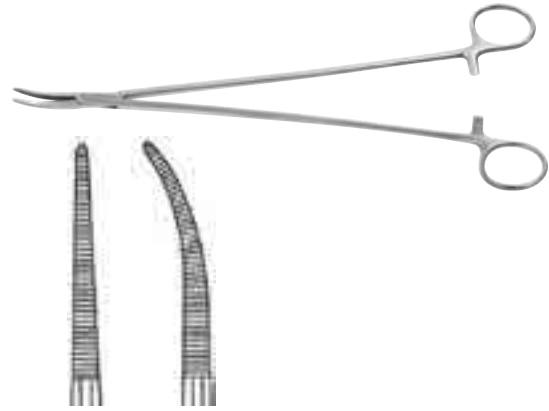

## HARRINGTON FORCEPS

Longitudinal serrations and cross-serrated tip.

Item Number	Description
MDS1246832	Slightly curved jaws, length $2\frac{3}{4}$ " (7cm), overall length $12\frac{1}{2}$ " (31.8cm)
MDS1246932	Right angled jaws, length $2\frac{3}{8}$ " (6cm), overall length 12" (30.5cm)



## HARRINGTON-MIXTER FORCEPS

Right-angled jaws with longitudinal serrations and cross-serrated tip.

Item Number	Description
MDS1391531	Overall length $12\frac{1}{2}$ " (31.8cm)



## LAHEY GALL DUCT FORCEPS

Right-angled, longitudinal serrations with cross-serrated tips.

Item Number	Description
MDS1245119	Overall length $7\frac{1}{2}$ " (19cm)



## GEMINI ARTERY FORCEPS

Fine "J" curve.

Item Number	Description
MDS1243113	Overall length 5½" (14cm)
MDS1243118	Overall length 7" (17.8cm)
MDS1243120	Overall length 8" (20.3cm)
MDS1243123	Overall length 9" (22.9cm)
MDS1243128	Overall length 11⅛" (28.3cm)



## LAWRENCE FORCEPS

Curved.

Item Number	Description
MDS1245728	Overall length 11" (27.8cm)

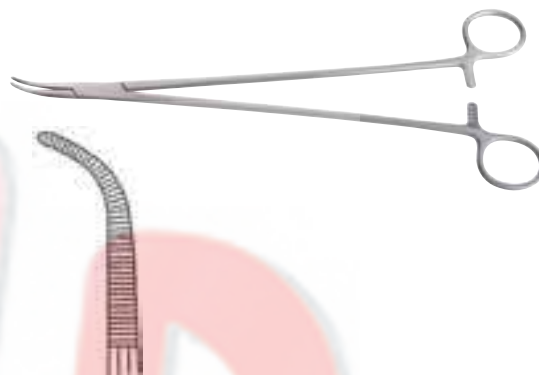

## KANTROWITZ THORACIC CLAMPS

Right-angled, serrated jaws.

Item Number	Description
MDS1243520	Overall length 7½" (19cm)
MDS1243515	Long handles, slender and fine, overall length 6" (15.2cm)
MDS1243524	Overall length 9½" (24.1cm)
MDS1243528	Overall length 10¾" (27.3cm)

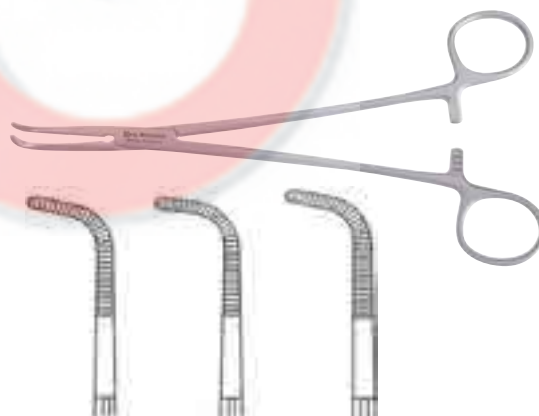

## ROCHESTER-MIXTER GALL DUCT FORCEPS

Fully curved. Fine.

Item Number	Description
MDS1244820	Overall length 7¾" (19.7cm)



## MEEKER ARTERY FORCEPS

Right-angled jaws.

<u>Item Number</u>	<u>Description</u>
MDS1245918	Overall length 7" (17.8cm)
MDS1245928	Overall length 11" (27.9cm)



## KANTROWITZ DRESSING FORCEPS

Curved, serrated tips. Angled jaws.

<u>Item Number</u>	<u>Description</u>
MDS1545012L	Overall length 12" (30.5cm)
MDS1545014L	Overall length 14" (35.6cm)

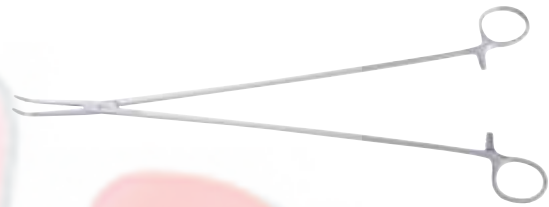

## MIXTER THORACIC FORCEPS (GEMINI-TYPE)

Fine, right-angled, serrated jaws.

<u>Item Number</u>	<u>Description</u>
MDS1243117	Overall length 7" (17.8cm)
MDS1243119	Overall length 8" (20.3cm)
MDS1243124	Overall length 9" (22.9cm)
MDS1243129	Overall length 11" (27.9cm)
MDS1243135	Overall length 14" (35.6cm)

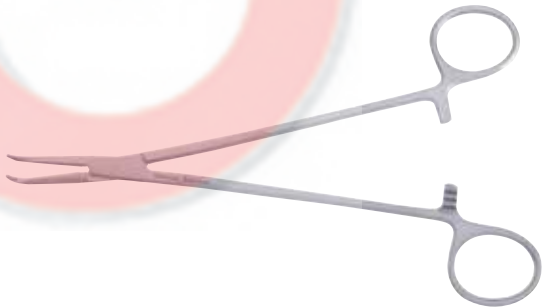

## MIXTER FORCEPS

Right-angled jaws with longitudinal serrations.

<u>Item Number</u>	<u>Description</u>
MDS1247922	Overall length 8½" (21.6cm)
MDS1247925	Overall length 10½" (26.7cm)
MDS1247928	Overall length 11½" (29.2cm)

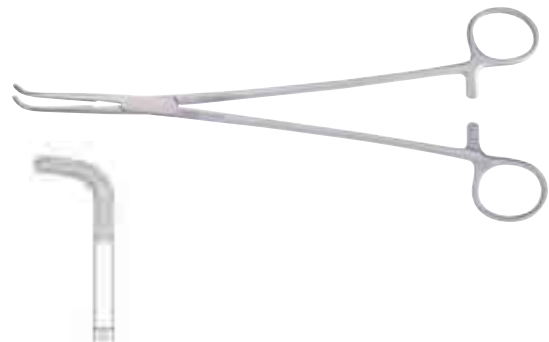

## UNIVERSITY OF MICHIGAN MIXTER FORCEPS

Strong curved, serrated jaws

Item Number	Description
MDS1247322	Overall length 9 <sup>1</sup> / <sub>4</sub> " (23.5cm)

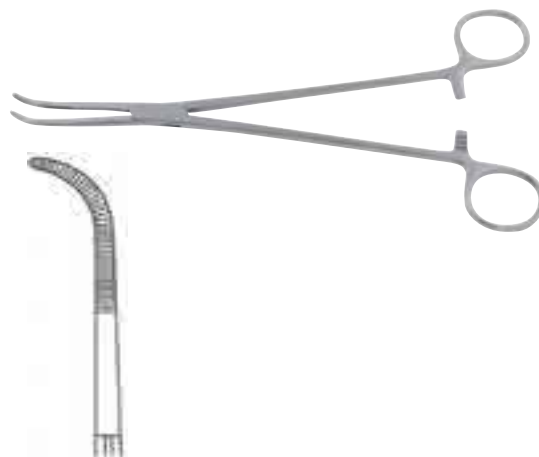

## FINOCHIETTO THORACIC FORCEPS

Longitudinally serrated right-angled jaws. Perforated tip.

Item Number	Description
MDS5630724	Overall length 9 <sup>3</sup> / <sub>4</sub> " (24.8cm)

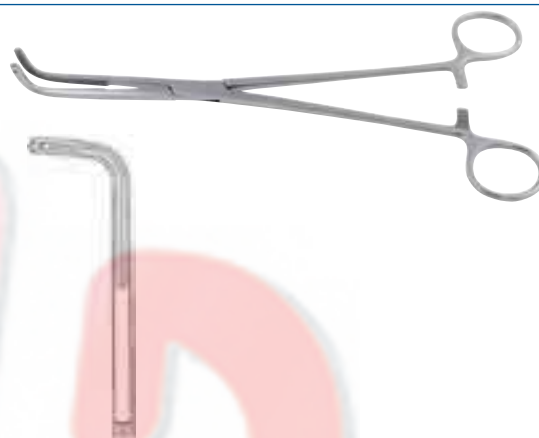

## BABCOCK TISSUE HOLDING FORCEPS

Item Number	Description
MDS6416020	Jaws 10.4mm wide, overall length 8" (20.3cm)

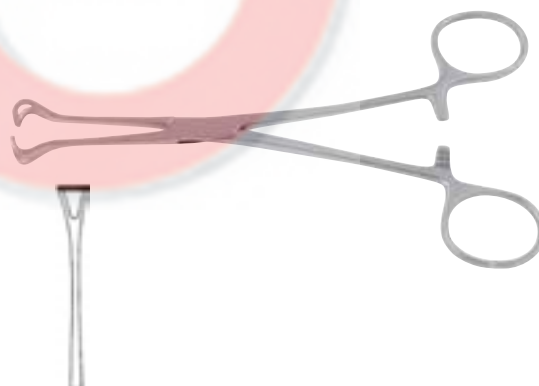

## BABCOCK THORACIC TISSUE FORCEPS

Item Number	Description
MDS6416024	Jaws 9.5mm wide, overall length 9 <sup>1</sup> / <sub>2</sub> " (24.1cm)
MDS6416124	Jaws 16mm wide, overall length 9 <sup>1</sup> / <sub>2</sub> " (24.1cm)



## ALLIS TISSUE FORCEPS

5 x 6 teeth.

<u>Item Number</u>	<u>Description</u>
MDS6412024	Overall length 10" (25.4cm)
MDS6412030	Overall length 12" (30.5cm)
MDS6412035	Overall length 14" (35.6cm)



## ADAIR TISSUE FORCEPS

<u>Item Number</u>	<u>Description</u>
MDS6413015	Overall length 6 1/4" (15.9cm)
MDS6413023	Overall length 9" (22.9cm)



## PENNINGTON TISSUE HOLDING FORCEPS

Triangular serrated jaws.

<u>Item Number</u>	<u>Description</u>
MDS1235820	Overall length 8" (20.3cm)

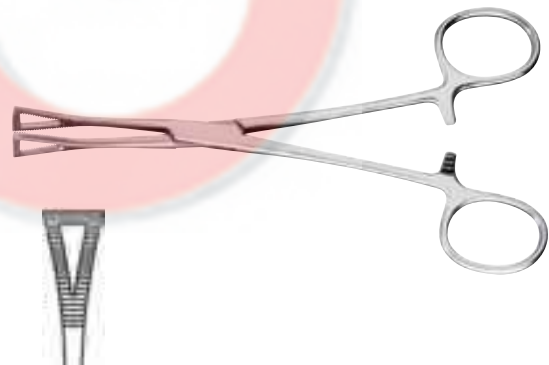

## LOVELACE LUNG FORCEPS

Angled shanks. Jaws 1" (25mm) wide.

<u>Item Number</u>	<u>Description</u>
MDS5629120	Overall length 8" (20cm)





## TURNER-BABCOCK TISSUE FORCEPS

With solid jaws and atraumatic transverse grooves for additional holding power.

Item Number	Description
MDS6416224	Overall length 9½" (24.1cm)



## COLLINS (DUVAL-CRILE) FORCEPS

Overall length 8" (20.3cm).

Item Number	Description
MDS6417020	Jaws ½" (13mm)
MDS6417220	Jaws 1" (25mm)

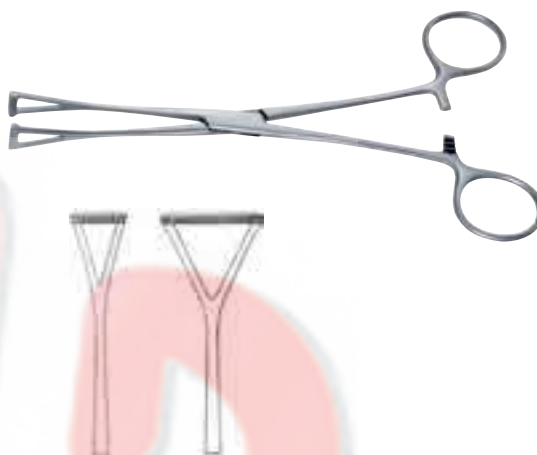

## SAROT BRONCHUS CLAMPS

Jaws 1½" (38mm) wide. Overall length 9" (22.9cm).

Item Number	Description
MDS1246123	Curved right
MDS1246223	Curved left

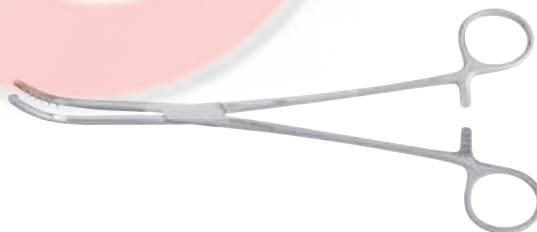

## LEES RIGHT ANGLE CLAMP

Jaw length 1½" (4cm).

Item Number	Description
MDS6421670	Overall length 8¾" (22.2cm)



## LEES BRONCHUS CLAMP

Jaw length 2" (5.1cm).

Item Number	Description
MDS6421675	Overall length 9 <sup>3</sup> / <sub>4</sub> " (24.8cm)



## SEMB DISSECTING FORCEPS/LIGATURE CARRIERS

Perforated tips for use as ligature carrier.  
Overall length 9<sup>1</sup>/<sub>2</sub>" (24.1cm).

Item Number	Description
MDS5631923	Slightly curved jaws
MDS5632323	Fully curved jaw



## FAVALORO-SEMB LIGATURE CARRIERS

Atraumatic tips.

Item Number	Description
MDS5631808	Fully curved jaws, overall length 11 <sup>1</sup> / <sub>8</sub> " (28.2cm)

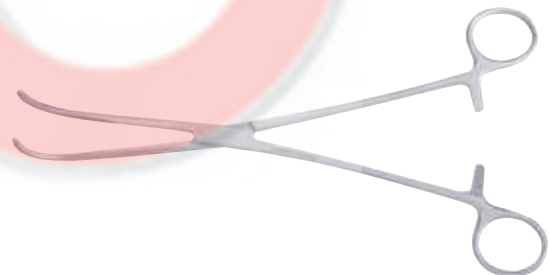

## DEBAKEY-SEMB LIGATURE CARRIER

Fully curved.

Item Number	Description
MDS5631809	Overall length 10" (25.4cm)

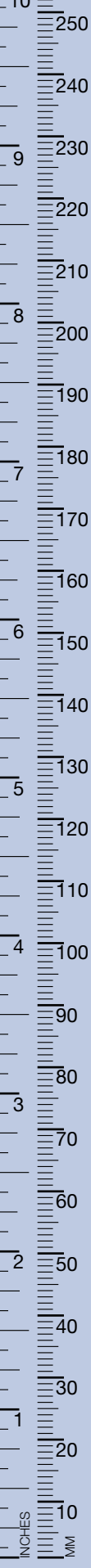

## HAND-APPLIED APPROXIMATOR CLAMPS

Flat jaws. Double. Without frame.

<u>Item Number</u>	<u>Description</u>
MDS4233034	Vessel size 2mm-5mm
MDS4233035	Vessel size 2mm-5mm, black
MDS4233061	Vessel size 1.5mm-3.5mm
MDS4233062	Vessel size 1.5mm-3.5mm, black



## CLAMP APPLYING FORCEPS

Offers the ability to open approximator clamps individually or simultaneously. For clamps used on vessel diameter from 0.4mm to 2.25mm. Without lock. Angled.

<u>Item Number</u>	<u>Description</u>
MDS4233144	Overall length 5 <sup>7</sup> / <sub>8</sub> " (15cm)

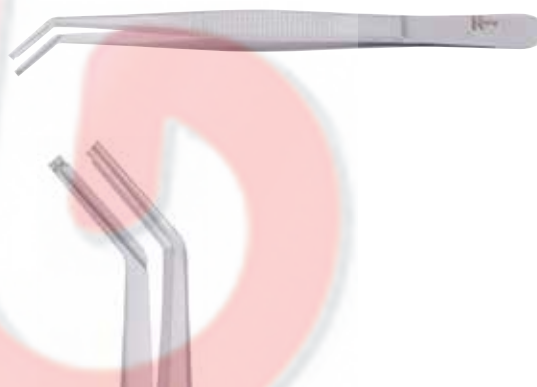

## CLAMP APPLYING FORCEPS

Straight. Overall length 5<sup>1</sup>/<sub>2</sub>" (14cm).

<u>Item Number</u>	<u>Description</u>
MDS4233145	Without lock
MDS4233146	With lock
MDS4233147	Without lock
MDS4233148	With lock

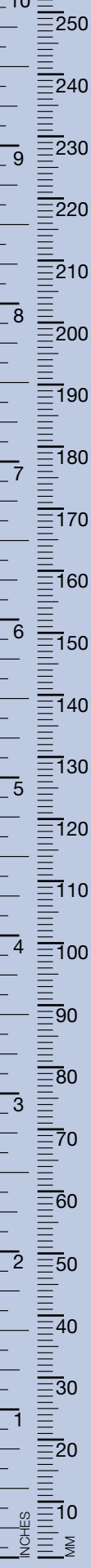

## MICRO CROSS-ACTION BULLDOG CLAMPS

Finely serrated jaws.

Item Number	Description
MDS1207108	Angled jaw, length $\frac{3}{8}$ " (1cm), overall length 2" (5.2cm)
MDS1207208	Straight jaws, length $\frac{3}{8}$ " (1cm), overall length 2" (5.2cm)
MDS1207112	Angled jaws, length $\frac{1}{2}$ " (1.3cm), overall length $2\frac{1}{8}$ " (5.4cm)
MDS1207212	Straight jaws, length $\frac{1}{2}$ " (1.3cm), overall length $2\frac{1}{4}$ " (5.7cm)



## WELDON MINIATURE BULLDOG CLAMPS

Finely serrated jaws, length  $\frac{1}{2}$ " (1.3cm).  
Overall length  $1\frac{3}{8}$ " (3.5cm).

Item Number	Description
MDS1207001	Straight jaws
MDS1207002	Curved jaws



## DIETHRICH ANGLED BULLDOG CLAMP

Serrated.

Item Number	Description
MDS1207120	Jaw 20mm, overall length $1\frac{7}{8}$ " (4.8cm)



## BULLDOG CLAMPS

<u>Item Number</u>	<u>Description</u>
MDS1201610	Angled jaws, length $\frac{3}{8}$ " (1cm), overall length $1\frac{1}{4}$ " (3.3cm)
MDS1201613	Angled jaws, length $\frac{1}{2}$ " (1.3cm), overall length $1\frac{1}{2}$ " (3.8cm)
MDS1201618	Angled jaws, length $\frac{3}{4}$ " (1.8cm), overall length $1\frac{1}{2}$ " (3.8cm)



## COOLEY BULLDOG CLAMPS

Adjustable screw to regulate jaw tension.  
Straight, finely serrated jaws.

<u>Item Number</u>	<u>Description</u>
MDS1209820	Jaw length $\frac{3}{4}$ " (1.9cm), overall length 2" (5.1cm)
MDS1209830	Jaw length $1\frac{1}{8}$ " (2.9cm), overall length $2\frac{5}{8}$ " (6.7cm)
MDS1209840	Jaw length $1\frac{7}{8}$ " (4.8cm), overall length $3\frac{3}{8}$ " (8.6cm)
MDS1209850	Jaw length $2\frac{3}{8}$ " (6cm), overall length 5" (12.7cm)

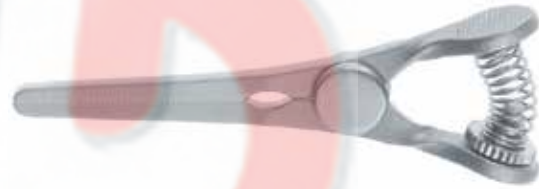

## COOLEY BULLDOG CLAMPS

Adjustable screw to regulate jaw tension.  
Curved, finely serrated jaws.

<u>Item Number</u>	<u>Description</u>
MDS1209920	Jaw length $\frac{3}{4}$ " (1.9cm), overall length $1\frac{3}{4}$ " (4.4cm)
MDS1209930	Jaw length 1" (2.5cm), overall length $2\frac{1}{2}$ " (6.4cm)
MDS1209940	Jaw length $1\frac{1}{2}$ " (3.8cm), overall length $3\frac{1}{8}$ " (7.9cm)
MDS1209950	Jaw length $2\frac{3}{8}$ " (6cm), overall length $4\frac{1}{2}$ " (11.4cm)



## COOLEY CROSS-ACTION BULLDOG CLAMPS

Curved jaw.

<b>Item Number</b>	<b>Description</b>
MDS1208408	Jaw length $\frac{5}{8}$ " (1.6cm), overall length $2\frac{7}{8}$ " (7.3cm)
MDS1208409	Jaw length 1" (2.5cm), overall length $3\frac{1}{4}$ " (8.3cm)
MDS1208410	Jaw length $1\frac{1}{2}$ " (3.8cm), overall length $3\frac{7}{8}$ " (9.8cm)
MDS1208412	Jaw length $2\frac{1}{4}$ " (5.7cm), overall length $4\frac{1}{2}$ " (11.4cm)



## COOLEY CROSS-ACTION BULLDOG CLAMPS

Straight jaw.

<b>Item Number</b>	<b>Description</b>
MDS1208508	Jaw length $\frac{7}{8}$ " (2.2cm), overall length 3" (7.6cm)
MDS1208509	Jaw length $1\frac{1}{8}$ " (2.9cm), overall length $3\frac{3}{8}$ " (8.6cm)
MDS1208510	Jaw length $1\frac{7}{8}$ " (4.8cm), overall length $4\frac{1}{4}$ " (10.8cm)
MDS1208512	Jaw length $2\frac{5}{8}$ " (6.7cm), overall length 5" (12.7cm)



## BULLDOG CLAMPS

Fine jaws.

<b>Item Number</b>	<b>Description</b>
MDS1206050	Straight jaw, length 3cm, overall length $2\frac{1}{2}$ " (6.5cm)
MDS1206052	Curved jaw, length 3cm, overall length $2\frac{1}{2}$ " (6.5cm)
MDS1206060	Straight jaw, length 4.8cm, overall length $3\frac{1}{8}$ " (8cm)
MDS1206062	Curved jaw, length 4.8cm, overall length $3\frac{1}{8}$ " (8cm)



## GREGORY BULLDOG CLAMPS

1 x 2 teeth.

<u>Item Number</u>	<u>Description</u>
MDS1316089	Straight jaw, length $1\frac{3}{16}$ " (3cm), overall length $3\frac{1}{2}$ " (8.9cm)
MDS1316090	Curved jaw, length $\frac{1}{2}$ " (1.25cm), overall length $4\frac{1}{4}$ " (10.8cm)
MDS1316091	Straight jaw, length $1\frac{3}{4}$ " (4.4cm), overall length $4\frac{1}{4}$ " (10.8cm)
MDS1316094	Curved jaw, length $1\frac{15}{16}$ " (4.9cm), overall length $3\frac{1}{2}$ " (8.9cm)



## GREGORY DEBAKEY BULLDOG CLAMP

Angled 45°, jaw length 7cm.

<u>Item Number</u>	<u>Description</u>
MDS1303511	Overall length $4\frac{3}{4}$ " (12.1cm)



## GREGORY SOFT BULLDOG CLAMPS

Overall length  $4\frac{3}{4}$ " (12cm).

<u>Item Number</u>	<u>Description</u>
MDS1303911	Curved right
MDS1303711	Curved left

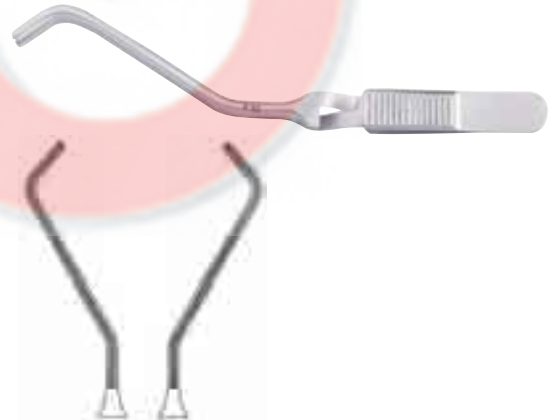

## JACOBSON BULLDOG CLAMPS

Adjustable screw to control tension.  
Finely serrated jaws, length  $\frac{7}{8}$ " (2.1cm).  
Overall length  $1\frac{3}{4}$ " (4.5cm).

<u>Item Number</u>	<u>Description</u>
MDS1209012	Straight
MDS1209112	Curved





## DEBAKEY CROSS-ACTION BULLDOG CLAMPS

Straight jaw.

Item Number	Description
MDS1209207	Jaw length 2cm, overall length 3" (7.6cm)
MDS1209208	Jaw length 3cm, overall length 3 <sup>3</sup> / <sub>8</sub> " (8.6cm)
MDS1209210	Jaw length 4.5cm, overall length 4 <sup>1</sup> / <sub>8</sub> " (10.5cm)
MDS1209212	Jaw length 6.5cm, overall length 4 <sup>3</sup> / <sub>4</sub> " (12cm)



## DEBAKEY CROSS-ACTION BULLDOG CLAMPS

Curved jaw.

Item Number	Description
MDS1209307	Jaw length 2cm, overall length 3" (7.6cm)
MDS1209308	Jaw length 3cm, overall length 3 <sup>3</sup> / <sub>8</sub> " (8.7cm)
MDS1209310	Jaw length 4.5cm, overall length 4 <sup>1</sup> / <sub>8</sub> " (10.5cm)
MDS1209312	Jaw length 6.5cm, overall length 4 <sup>3</sup> / <sub>4</sub> " (12cm)



## DEBAKEY RING-HANDLED BULLDOG CLAMPS

Item Number	Description
MDS1310212	Straight, Overall length 5 <sup>1</sup> / <sub>8</sub> " (13cm)
MDS1310312	Curved jaws, length 4.8cm, overall length 5 <sup>1</sup> / <sub>8</sub> " (13cm)
MDS1311112	Curved shanks. Jaw angled 45°, length 4cm, overall length 5" (12.7cm)

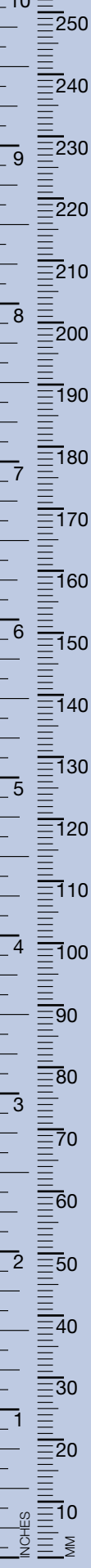
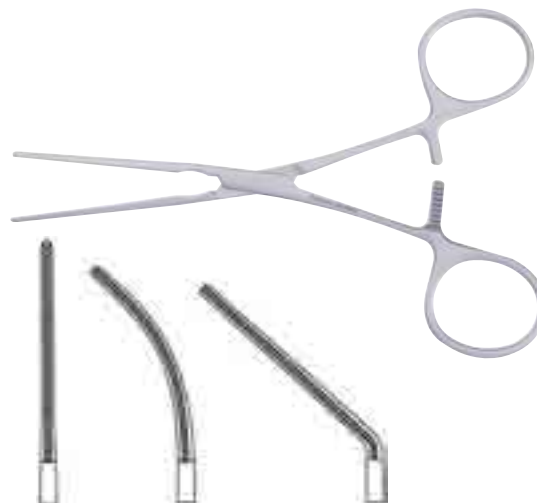

## DEBAKEY RING-HANDLED BULLDOG CLAMP

Straight shanks.

Item Number	Description
MDS1311312	Jaw angled 90°, length 4cm, overall length 3 <sup>3</sup> / <sub>4</sub> " (10cm)



## DEBAKEY CLAMP

Curved shanks.

Item Number	Description
MDS1312112	Curved jaw, length 4.5cm, overall length 5" (12.7cm)



## SELMAN PERIPHERAL BLOOD VESSEL FORCEPS

Fully curved Cooley jaws.

Item Number	Description
MDS1437281	Jaws 15mm x 8.5mm deep, overall length 5" (12.7cm)



## COOLEY PATENT DUCTUS CLAMPS

Jaw length 1<sup>1</sup>/<sub>4</sub>" (3.2cm). Overall length 6<sup>1</sup>/<sub>4</sub>" (15.9cm).

Item Number	Description
MDS1337616	Straight shanks
MDS1337716	Angled shanks



## COOLEY CLAMPS

Jaw length 3cm.

<u>Item Number</u>	<u>Description</u>
MDS1342014	Straight, overall length 5 <sup>1</sup> / <sub>4</sub> " (13.3cm)
MDS1342114	Angled jaws, overall length 5 <sup>1</sup> / <sub>4</sub> " (13.3cm)
MDS1342314	Straight jaws, angled shanks, overall length 5 <sup>1</sup> / <sub>4</sub> " (13.3cm)
MDS1342414	Curved jaws, overall length 5 <sup>1</sup> / <sub>2</sub> " (14cm)



## COOLEY-SATINSKY CLAMP

Jaw length 30mm, depth 5mm.

<u>Item Number</u>	<u>Description</u>
MDS1343314	Overall length 5 <sup>1</sup> / <sub>2</sub> " (14cm)



## COOLEY TANGENTIAL OCCLUSION CLAMPS

Double-angled jaws are calibrated in 5mm increments.  
Overall length 7<sup>3</sup>/<sub>4</sub>" (19.7cm).

<u>Item Number</u>	<u>Description</u>
MDS1346570	Jaw length <sup>3</sup> / <sub>4</sub> " (1.9cm), depth 6mm
MDS1346572	Jaw length 1" (2.5cm), depth 7mm
MDS1346574	Jaw length 1 <sup>3</sup> / <sub>8</sub> " (3.5cm), depth 10mm



## COOLEY PATENT DUCTUS CLAMPS

Straight jaws, length 1<sup>1</sup>/<sub>8</sub>" (3cm).  
Overall length 8<sup>1</sup>/<sub>4</sub>" (21cm).

<u>Item Number</u>	<u>Description</u>
MDS1342721	Straight shanks
MDS1341721	Angled shanks



**COOLEY COARCTATION CLAMP**

Angled shanks. Jaw length 1½" (3.8cm).

<b>Item Number</b>	<b>Description</b>
MDS1341717	Overall length 6¾" (17.1cm)

**SATINSKY PEDIATRIC CLAMP**

Cooley jaws. Jaw length 1" (2.5cm), depth 5mm.

<b>Item Number</b>	<b>Description</b>
MDS1350206	Overall length 5½" (14cm)

**DEBAKEY PATENT DUCTUS AND PERIPHERAL VASCULAR CLAMPS**

Straight jaws, length 1⅛" (3cm).  
Overall length 8" (20.3cm).

<b>Item Number</b>	<b>Description</b>
MDS14316791	Angled shanks

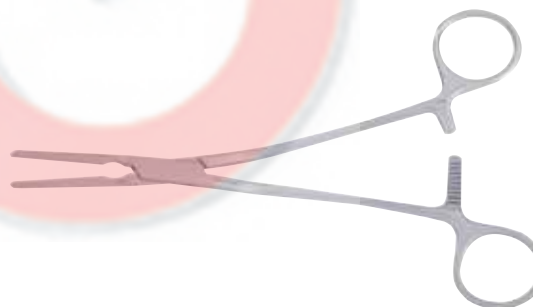
**KITZMILLER-TYPE CLAMPS**

Cooley jaws. Overall length 5¼" (13.4cm).

<b>Item Number</b>	<b>Description</b>
MDS1436510	Angled left
MDS1436512	Angled right



## DEBAKEY PATENT DUCTUS AND PERIPHERAL VASCULAR CLAMPS

Straight jaws, length 1 $\frac{1}{8}$ " (3cm).  
Overall length 8" (20.3cm).

<u>Item Number</u>	<u>Description</u>
MDS1431699	Straight shanks



## THOMPSON CAROTID CLOSURE CLAMP

Handles slightly curved. Long jaw, 1mm thick.

<u>Item Number</u>	<u>Description</u>
MDS1432851	Overall length 6 $\frac{1}{8}$ " (15.5cm)



## KARTCHNER INTERNAL CAROTID CLAMP

Long, slightly curved handles.  
Long jaw, length 1 $\frac{3}{8}$ " (3.5cm).

<u>Item Number</u>	<u>Description</u>
MDS1432853	Overall length 6 $\frac{3}{8}$ " (16.2cm)

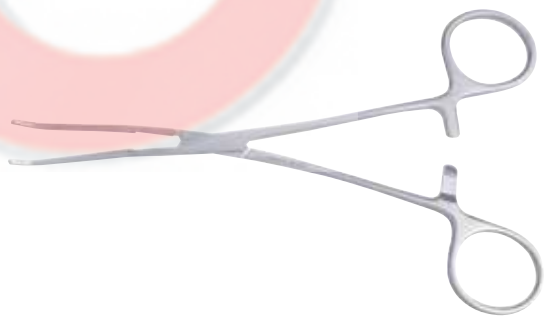

## COOLEY PERIPHERAL VASCULAR CLAMP

Light. Straight. Jaw length 1 $\frac{3}{4}$ " (4.4cm).

<u>Item Number</u>	<u>Description</u>
MDS1431017	Overall length 6 $\frac{3}{4}$ " (17.1cm)

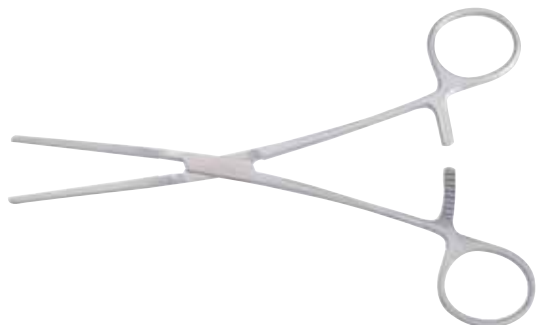

## SELMAN PERIPHERAL BLOOD VESSEL FORCEPS

Straight Cooley jaws.

Item Number	Description
MDS1436150	Jaw length 1.3cm, overall length 5" (12.7cm)
MDS1436152	Jaw length 2.5cm, overall length 5½" (14cm)



## SELMAN PERIPHERAL BLOOD VESSEL FORCEPS

Angled Cooley jaws.

Item Number	Description
MDS1436151	Jaw length 1.3cm, overall length 5" (12.7cm)
MDS1436153	Jaw length 2.1cm, overall length 5½" (14cm)



## DEBAKEY PERIPHERAL VASCULAR CLAMP

Lightweight shanks. Slight curve in shank with full angle in jaw distal. Jaw length 2¾" (6cm).

Item Number	Description
MDS1318119	Overall length 7" (17.8cm)

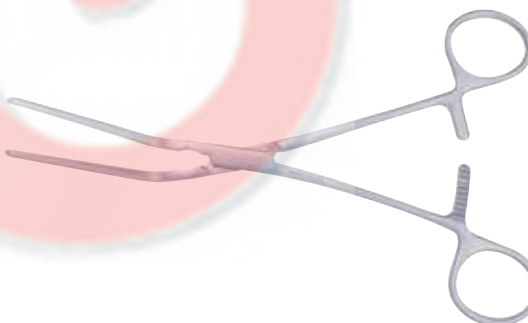

## COOLEY PERIPHERAL VASCULAR CLAMPS

Light. Jaws angled 55°.

Item Number	Description
MDS1436298	Jaw length 1¾" (3.5cm), overall length 6½" (16.5cm)
MDS1436299	Jaw length 1¾" (4.4cm), overall length 6¾" (17.1cm)
MDS1436311	Jaw length 2¾" (7cm), overall length 7" (17.8cm)
MDS1436312	Jaw length 1¾" (4.4cm), overall length 7" (17.8cm)



## LELAND JONES PERIPHERAL VASCULAR CLAMPS

Jaw length 3 $\frac{1}{2}$ " (8.9cm). Overall length 7 $\frac{1}{2}$ " (19cm).

<u>Item Number</u>	<u>Description</u>
MDS1438203	Jaws angled 15°
MDS1438205	Jaws angled 30°



## DEBAKEY CURVED PERIPHERAL VASCULAR CLAMP

A small, lightweight clamp.  
Curved jaws, length 1 $\frac{7}{8}$ " (4.8cm).

<u>Item Number</u>	<u>Description</u>
MDS1318266	Overall length 6" (15.2cm)



## DEBAKEY S-SHAPED PERIPHERAL VASCULAR CLAMP

Curved jaws and light, springy handles conform to an S-shape. Jaw length 3 $\frac{3}{8}$ " (8.5cm).

<u>Item Number</u>	<u>Description</u>
MDS1318320	Overall length 8" (20.3cm)

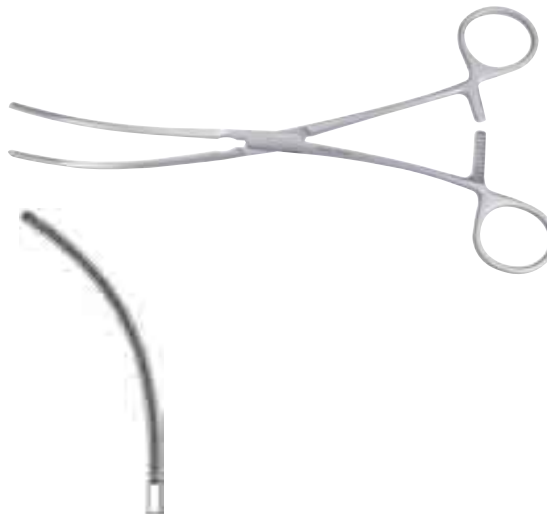



**DEBAKEY-BAINBRIGE VASCULAR CLAMP**

<b>Item Number</b>	<b>Description</b>
MDS1438228	Curved, jaw length $2\frac{3}{8}$ " (6cm), overall length 7" (17.8cm)

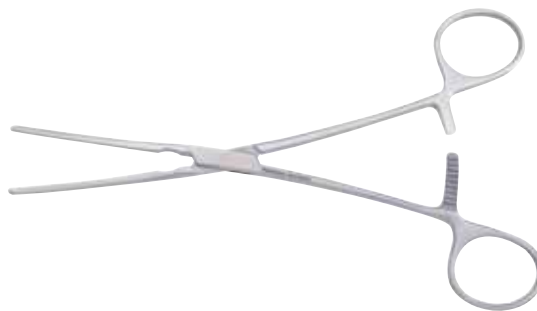
**COOLEY AORTIC ANEURYSM CLAMP**

Slightly curved jaws.

<b>Item Number</b>	<b>Description</b>
MDS1437391	Jaw length 3" (7.6cm), overall length $10\frac{3}{4}$ " (27.3cm)

**COOLEY AORTA CLAMPS**

Curved shanks.

<b>Item Number</b>	<b>Description</b>
MDS1437555	Jaw length $1\frac{7}{8}$ " (4.7cm), depth $\frac{1}{2}$ " (1.3cm), overall length 8" (20.3cm)
MDS1437557	Jaw length $2\frac{1}{8}$ " (5.4cm), depth $\frac{1}{2}$ " (1.3cm), overall length $10\frac{3}{4}$ " (27.3cm)



## GREGORY PROFUNDA CLAMPS

<u>Item Number</u>	<u>Description</u>
MDS1334914	Small, jaw length 1 <sup>3</sup> / <sub>4</sub> " (4.4cm), overall length 5 <sup>7</sup> / <sub>8</sub> " (13.7cm)
MDS1334918	Medium, jaw length 2 <sup>1</sup> / <sub>2</sub> " (6.2cm), overall length 7" (17.8cm)
MDS1334920	Large, jaw length 2 <sup>7</sup> / <sub>8</sub> " (7.3cm), overall length 7 <sup>3</sup> / <sub>4</sub> " (19.7cm)



## BAILEY AORTIC CLAMPS

Angled shafts.

<u>Item Number</u>	<u>Description</u>
MDS1438395	Extra small jaws, length 1 <sup>1</sup> / <sub>8</sub> " (29mm), depth 8mm, overall length 8" (20.3cm)
MDS1438397	Small jaws length 1 <sup>3</sup> / <sub>4</sub> " (44mm), depth 11mm, overall length 8" (20.3cm)
MDS1438399	Small jaws length 2 <sup>1</sup> / <sub>8</sub> " (54mm), depth 11mm, overall length 9 <sup>3</sup> / <sub>4</sub> " (24.8cm)



## ZANGER ABDOMINAL AORTA CLAMPS

Angled.

<u>Item Number</u>	<u>Description</u>
MDS1438315	Overall length 9 <sup>1</sup> / <sub>2</sub> " (24.1cm)



## DEBAKEY AORTIC CLAMP

Curved jaws and light, springy shanks conform to S-shape.

<u>Item Number</u>	<u>Description</u>
MDS1438286	Jaw length 3" (7.6cm), overall length 7 <sup>1</sup> / <sub>4</sub> " (18.4cm)



## DEBAKEY AORTIC ANEURYSM CLAMPS

Slightly curved jaws.

Item Number	Description
MDS1322126	Jaw length $3\frac{3}{4}$ " (9.5cm), overall length $10\frac{1}{2}$ " (26.5cm)
MDS1322131	Jaw length 4" (10cm), overall length 12" (30.5cm)

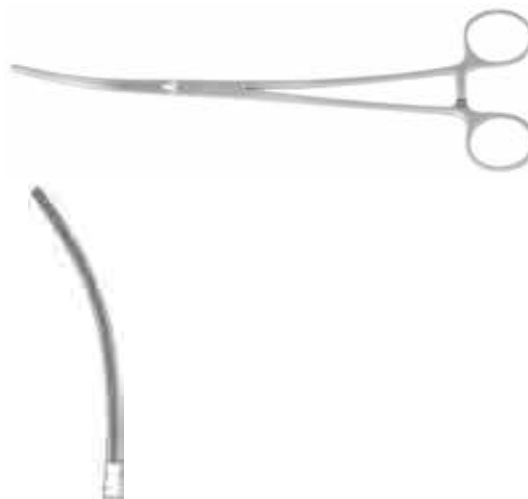

## FITZGERALD AORTIC ANEURYSM CLAMPS

Slightly curved Cooley jaws.

Item Number	Description
MDS1437371	Jaw length $3\frac{1}{4}$ " (8.5cm), overall length 10" (25.4cm)
MDS1437373	Jaw length $3\frac{3}{4}$ " (9.5cm), overall length $10\frac{3}{4}$ " (26.5cm)
MDS1437381	Jaw length $4\frac{1}{2}$ " (11.4cm), overall length $12\frac{1}{4}$ " (31cm)
MDS1437383	Jaw length $5\frac{1}{4}$ " (13.2cm), overall length 13" (33cm)



## DEBAKEY COARCTATION AND PERIPHERAL VASCULAR CLAMPS

Straight, non-crushing jaws, length  $2\frac{1}{8}$ " (5.4cm).  
Overall length 9" (22.9cm).

Item Number	Description
MDS1314022	Angled shanks



## WYLIE ABDOMINAL AORTA CLAMP

<u>Item Number</u>	<u>Description</u>
MDS1438567	Overall length 8½" (21.6cm)



## LEMOLE-STRONG AORTA CLAMPS

Jaw width 1¾" (4.4cm), depth 7⁄8" (2.2cm).

<u>Item Number</u>	<u>Description</u>
MDS1438501	Straight, overall length 7¾" (19.6cm)
MDS1438503	Angled, overall length 8" (20.3cm)



## COOLEY AORTA CLAMP

Curved shanks.

<u>Item Number</u>	<u>Description</u>
MDS1437553	Jaw length 27⁄8" (7.3cm), depth ¾" (1.9cm), overall length 10" (25.4cm)



## KAY AORTA CLAMP

DeBakey jaws.

<u>Item Number</u>	<u>Description</u>
MDS1321320	Jaw length 1¾" (4.5cm), depth 1¼" (3.2cm), overall length 8" (20.3cm)



## LAMBERT-KAY AORTA CLAMP

DeBaKey jaws.

Item Number	Description
MDS1321120	Jaw length 1 <sup>3</sup> / <sub>4</sub> " (4.5cm), depth 3/4" (1.9cm), overall length 8" (20.3cm)



## PARSONNET AORTA CLAMPS

The jaws, available in four sizes.

Item Number	Description
MDS1456112	Jaw length at base 1 <sup>1</sup> / <sub>8</sub> " (2.8cm), overall length 9 <sup>3</sup> / <sub>8</sub> " (23.8cm)
MDS1456113	Jaw length at base 1 <sup>1</sup> / <sub>4</sub> " (3.2cm), overall length 9 <sup>3</sup> / <sub>8</sub> " (23.8cm)
MDS1456114	Jaw length at base 1 <sup>1</sup> / <sub>2</sub> " (3.8cm), overall length 9 <sup>1</sup> / <sub>2</sub> " (24.1cm)
MDS1456115	Jaw length at base 1 <sup>3</sup> / <sub>4</sub> " (4.4cm), overall length 9 <sup>3</sup> / <sub>4</sub> " (24.8cm)

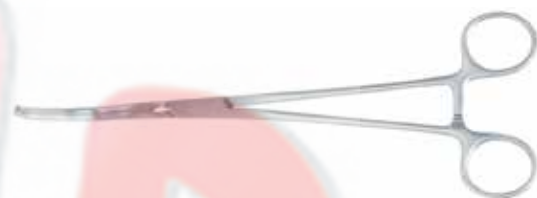

## SUBRAMANIAN "SIDEWINDER" AORTA CLAMP

Double curved jaws, length 1<sup>1</sup>/<sub>8</sub>" (2.9cm).

Item Number	Description
MDS1333115	Overall length 5 <sup>1</sup> / <sub>2</sub> " (14cm)



## DEBAKEY "SIDEWINDER" AORTA CLAMPS

Double curved jaws.

Item Number	Description
MDS1488363	Jaw length 1 <sup>3</sup> / <sub>4</sub> " (4.5cm), overall length 9" (22.9cm)
MDS1438362	Jaw length 2 <sup>3</sup> / <sub>8</sub> " (6cm), overall length 10 <sup>1</sup> / <sub>2</sub> " (26.7cm)



## COOLEY-DERRA CLAMPS

Derra-type jaws calibrated in 5mm increments.  
Overall length 6 $\frac{1}{2}$ " (16.5cm).

<u>Item Number</u>	<u>Description</u>
MDS1344116	Jaw length $\frac{3}{4}$ " (1.9cm), depth $\frac{3}{8}$ " (1cm)
MDS1344117	Jaw length $\frac{7}{8}$ " (2.2cm), depth $\frac{1}{2}$ " (1.3cm)
MDS1344118	Jaw length 1 $\frac{1}{4}$ " (3.2cm), depth $\frac{5}{8}$ " (1.6cm)

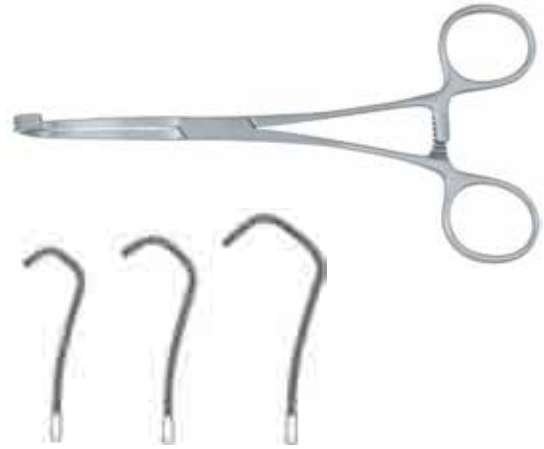

## DERRA MINIATURE ANASTOMOSIS CLAMPS

<u>Item Number</u>	<u>Description</u>
MDS1329116	Small, jaw $\frac{1}{2}$ " (1.5cm), overall length 6 $\frac{7}{8}$ " (17.4cm)
MDS1328917	Medium, jaw $\frac{3}{4}$ " (2cm), overall length 7 $\frac{1}{8}$ " (18cm)
MDS1329118	Large, jaw 1" (2.5cm), overall length 6 $\frac{3}{4}$ " (17.2cm)

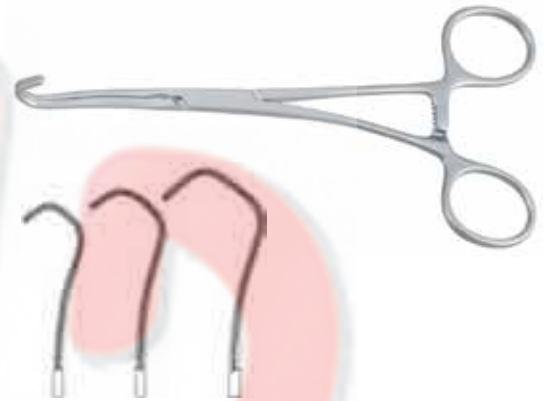

## COOLEY CURVED CLAMP

Light. Fully curved jaws.

<u>Item Number</u>	<u>Description</u>
MDS1341317	Jaw length 1 $\frac{1}{8}$ " (2.9cm), overall length 6 $\frac{1}{4}$ " (15.9cm)



## COOLEY ILIAC CLAMPS

Curved shanks, angled 45°.  
Straight jaws, length 2 $\frac{3}{8}$ " (6cm).

<u>Item Number</u>	<u>Description</u>
MDS1437751	Overall length 8 $\frac{1}{4}$ " (21.0cm)
MDS1437753	Overall length 10" (25.4cm)



## DERRA VENA CAVA CLAMPS

Longitudinally serrated jaws. Overall length 7<sup>7</sup>/<sub>8</sub>" (20cm).

Item Number	Description
MDS1436108	Jaw length 20mm, depth 14mm
MDS1436106	Jaw length 28mm, depth 15mm
MDS1436107	Jaw length 25mm, depth 16mm



## SATINSKY VENA CAVA CLAMPS

Cross-serrated jaws.

Item Number	Description
MDS5632926	Jaw length 1 <sup>1</sup> / <sub>4</sub> " (3.2cm), depth <sup>3</sup> / <sub>8</sub> " (9mm), overall length 9 <sup>1</sup> / <sub>2</sub> " (24.1cm)
MDS5632726	Jaw length 1 <sup>3</sup> / <sub>4</sub> " (4.4cm), depth <sup>1</sup> / <sub>2</sub> " (1.3cm), overall length 10" (25.4cm)



## DEBAKEY SATINSKY CLAMPS

Overall length 10<sup>1</sup>/<sub>2</sub>" (26.7cm).

Item Number	Description
MDS1438412	Extra small jaws, 1 <sup>5</sup> / <sub>8</sub> " (4cm), depth <sup>5</sup> / <sub>16</sub> " (0.9cm)
MDS1438411	Small jaws, length 2" (5.1cm), depth <sup>5</sup> / <sub>16</sub> " (0.9cm)
MDS1438416	Small jaws, length 2" (5.1cm), depth <sup>1</sup> / <sub>2</sub> " (1.3cm)
MDS1438413	Medium jaws, length 2 <sup>1</sup> / <sub>8</sub> " (5.4cm), depth <sup>3</sup> / <sub>4</sub> " (1.9cm)
MDS1438415	Large jaws, length 2 <sup>3</sup> / <sub>8</sub> " (6cm), depth <sup>3</sup> / <sub>4</sub> " (1.9cm)

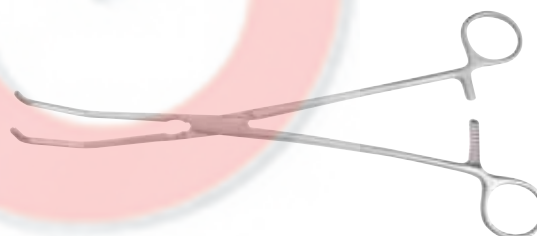

## COOLEY COARCTATION CLAMPS

Straight jaws.

Item Number	Description
MDS1437411	Straight shanks, jaw length 2" (5.1cm), overall length 8 <sup>3</sup> / <sub>4</sub> " (22.2cm)
MDS1437413	Straight shanks, jaw length 2 <sup>3</sup> / <sub>4</sub> " (7cm), overall length 9 <sup>3</sup> / <sub>4</sub> " (24.8cm)
MDS1437421	Angled shanks, jaw length 2" (5.1cm), overall length 8 <sup>3</sup> / <sub>4</sub> " (22.2cm)
MDS1437423	Angled shanks, jaw length 2 <sup>3</sup> / <sub>4</sub> " (7cm), overall length 9 <sup>3</sup> / <sub>4</sub> " (24.8cm)





## COOLEY COARCTATION CLAMPS

Straight shanks. Jaw length 1½" (3.8cm).  
Overall length 6¾" (17.1cm).

<u>Item Number</u>	<u>Description</u>
MDS1341017	Straight jaw
MDS1342317	Curved jaw



## CRAFOORD COARCTATION CLAMP

Longitudinally serrated jaws, length 2¾" (7cm).

<u>Item Number</u>	<u>Description</u>
MDS1231524	Overall length 9¼" (23.5cm)



## CRAFOORD COARCTATION FORCEPS

<u>Item Number</u>	<u>Description</u>
MDS1437472	Slightly curved jaws, length 2¾" (7cm), overall length 9¼" (23.5cm)



## DEBAKEY COARCTATION AND PERIPHERAL VASCULAR CLAMPS

Straight, non-crushing jaws, length 2⅛" (5.4cm).  
Overall length 9" (22.9cm).

<u>Item Number</u>	<u>Description</u>
MDS1310223	Straight shank
MDS1314022	Angled shanks



## GLOVER COARCTATION CLAMPS

Item Number	Description
MDS1438291	Extra-long, straight, jaw length 2 <sup>3</sup> / <sub>4</sub> " (7cm), overall length 10 <sup>1</sup> / <sub>2</sub> " (26.7cm)
MDS1438293	Extra-long, angled, jaw length 2 <sup>3</sup> / <sub>4</sub> " (7cm), overall length 10 <sup>1</sup> / <sub>2</sub> " (26.7cm)
MDS1438295	Straight, jaw length 2 <sup>1</sup> / <sub>8</sub> " (5.4cm), overall length 9" (23cm)
MDS1438297	Angled, jaw length 2 <sup>1</sup> / <sub>8</sub> " (5.4cm), overall length 8 <sup>7</sup> / <sub>8</sub> " (22.5cm)



## HARKEN CLAMPS

Curved jaw with cross-serrations.

Item Number	Description
MDS1371324	Jaw length 3 <sup>1</sup> / <sub>8</sub> " (8cm), overall length 9 <sup>3</sup> / <sub>4</sub> " (24.8cm)

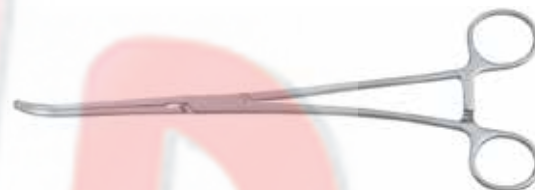

## CASTANEDA MULTI-PURPOSE CLAMPS

Jaw length 1<sup>3</sup>/<sub>8</sub>" (3.5cm). Overall length 5" (12.7cm).

Item Number	Description
MDS1348313	Jaws angled 30°
MDS1348513	Jaws angled 50°
MDS1348911	Jaws angled 90°



## DEBAKEY-CASTANEDA CLAMPS

Fine, narrow. 1.4mm DeBakey jaws. Overall length 4<sup>3</sup>/<sub>4</sub>" (12.1cm).

Item Number	Description
MDS1438924	Jaws angled 45°, curved shaft
MDS1438925	Jaws angled 60°, curved shaft
MDS1438926	Jaws angled 90°, curved shaft



## DEBAKEY MINIATURE MULTI-PURPOSE CLAMPS

Jaw length  $1\frac{1}{8}$ " (2.9cm). Overall length  $6\frac{1}{2}$ " (16.5cm).

<u>Item Number</u>	<u>Description</u>
--------------------	--------------------

MDS1318231	Jaws angled 30°
------------	-----------------

MDS1331115	Jaws angled 60°
------------	-----------------

MDS1331114	Jaws angled 90°
------------	-----------------



## DEBAKEY MULTI-PURPOSE CLAMPS

Jaws angled 90°.

<u>Item Number</u>	<u>Description</u>
--------------------	--------------------

MDS1323121	Jaw length 2" (5.1cm), overall length 8" (20.3cm)
------------	--

MDS1323123	Jaw length $2\frac{1}{2}$ " (6.4cm), overall length $8\frac{1}{2}$ " (21.6cm)
------------	--



## DEBAKEY MULTI-PURPOSE CLAMPS

Curved shanks. Jaws angled 60°.

<u>Item Number</u>	<u>Description</u>
--------------------	--------------------

MDS1325521	Jaw length 2" (5.1cm), overall length $8\frac{1}{4}$ " (21cm)
------------	--

MDS1325522	Jaw length $2\frac{1}{2}$ " (6.4cm), overall length $8\frac{1}{2}$ " (21.5cm)
------------	--

MDS1325130	Jaw length 4" (10.2cm), overall length 12" (30.5cm)
------------	--



## COOLEY MULTI-PURPOSE CURVED CLAMPS

Acutely curved jaws are calibrated in 5mm increments. Angled shanks. Overall length 8" (20.3cm).

<u>Item Number</u>	<u>Description</u>
--------------------	--------------------

MDS1437731	Jaw length $1\frac{1}{4}$ " (3.2cm), depth $\frac{5}{8}$ " (1.6cm)
------------	---

MDS1437733	Jaw length $1\frac{1}{2}$ " (3.8cm), depth $\frac{3}{4}$ " (1.9cm)
------------	---

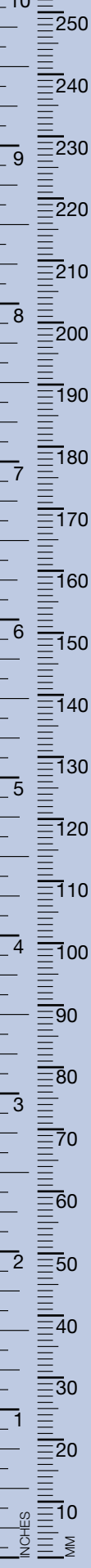

## COOLEY MULTI-PURPOSE CLAMPS

Jaws are calibrated in 5mm increments.

Item Number	Description
MDS1343130	Jaw angled 30°, length 1½" (3.8cm), overall length 6½" (16.5cm)
MDS1343160	Jaw angled 60°, length 1½" (2.9cm), overall length 6⅛" (15.6cm)
MDS1343190	Jaw angled 90°, length 1½" (3.8cm), overall length 5½" (14cm)



## CASTANEDA ANASTOMOSIS CLAMPS

Overall length 6" (15.2cm).

Item Number	Description
MDS1437908	Jaw length ⅝" (1.5cm), depth 5mm
MDS1437909	Jaw length ¾" (1.8cm), depth 6mm
MDS1437910	Jaw length 7⁄8" (2.1cm), depth 7mm



## COOLEY DOUBLE-ANGLED CLAMPS

Jaws calibrated in 5mm increments, angled 60°.

Item Number	Description
MDS1345717	Jaw length 1½" (3.8cm), depth 7.6mm, overall length 7" (17.8cm)

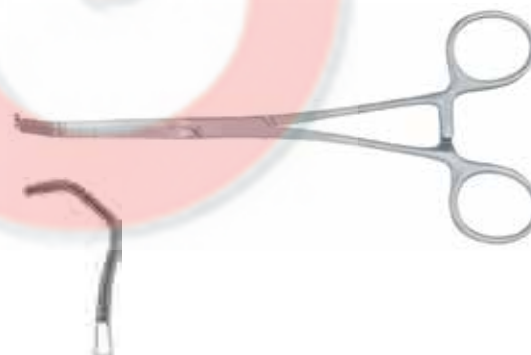

## COOLEY DOUBLE-ANGLED CLAMPS

Jaws calibrated in 5mm increments, angled 90°.

Item Number	Description
MDS1346117	Jaw length 1" (2.5cm), depth 6.8mm, overall length 6½" (16.5cm)



## COOLEY CAROTID, SUBCLAVIAN, AND RENAL (CSR) ARTERY CLAMPS

Jaws angled  $\frac{1}{3}$  of the distance from the distal tip and calibrated in 5mm increments.

<u>Item Number</u>	<u>Description</u>
MDS1437711	Jaw length $2\frac{1}{2}$ " (6.3cm), overall length $7\frac{1}{4}$ " (18.4cm)
MDS1437713	Jaw length 3" (7.6cm), overall length 9" (22.9cm)
MDS1437715	Jaw length 4" (10.2cm), overall length $10\frac{3}{4}$ " (27.3cm)



## HENLY SUBCLAVIAN ARTERY CLAMP

Double-angled jaws.

<u>Item Number</u>	<u>Description</u>
MDS1438713	Overall length $8\frac{1}{2}$ " (21.6cm)



## COOLEY ANASTOMOSIS CLAMPS

Double-angled jaws are calibrated in 5mm increments. Angled shanks. Overall length  $6\frac{1}{2}$ " (16.5cm).

<u>Item Number</u>	<u>Description</u>
MDS1437678	Jaw length $\frac{3}{4}$ " (1.9cm), depth 7.3mm
MDS1437679	Jaw length $\frac{3}{4}$ " (1.9cm), depth 6mm

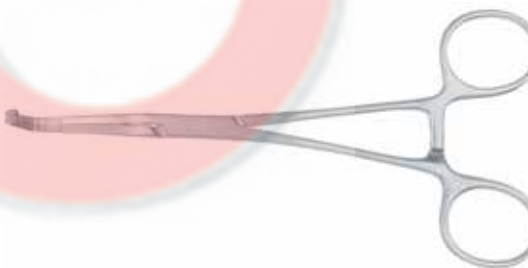

## COOLEY PARTIAL OCCLUSION CLAMPS

<u>Item Number</u>	<u>Description</u>
MDS1437761	Jaw length 1" (2.5cm), depth 7mm, overall length 8" (20.3cm)
MDS1437762	Jaw length $1\frac{3}{8}$ " (3.5cm), depth 7mm, overall length $8\frac{1}{2}$ " (21.6cm)
MDS1437763	Jaw length 2" (5.1cm), depth 1.2cm, overall length 9" (22.9cm)
MDS1437765	Jaw length $2\frac{7}{8}$ " (7.3cm), depth 1.2cm, overall length $10\frac{3}{4}$ " (27.3cm)



## COOLEY AURICULAR APPENDAGE FORCEPS

Jaws  $1\frac{5}{8}$ " (4.1cm) x  $\frac{3}{8}$ " (1cm).

<u>Item Number</u>	<u>Description</u>
MDS1437759	Overall length 10" (25.4cm)



## DEBAKEY TANGENTIAL OCCLUSION CLAMPS

<u>Item Number</u>	<u>Description</u>
MDS1438301	Jaw length 3.5cm, depth 1.1cm, overall length $7\frac{3}{4}$ " (19.7cm)
MDS1438303	Jaw length 4.8cm, depth 1.6cm, overall length $10\frac{1}{4}$ " (26cm)
MDS1438305	Jaw length 5.5cm, depth 1.5cm, overall length $10\frac{1}{2}$ " (26.7cm)
MDS1438307	Jaw length 6cm, depth 1.4cm, overall length $10\frac{3}{4}$ " (27.3cm)
MDS1438309	Jaw length 7.5cm, depth 1.7cm, overall length 11" (28cm)



## COOLEY CURVED CARDIOVASCULAR CLAMP

Curved jaws, length  $2\frac{1}{8}$ " (5.4cm).

<u>Item Number</u>	<u>Description</u>
MDS1437466	Overall length $8\frac{1}{4}$ " (21cm)



## COOLEY CARDIOVASCULAR CLAMP

Curved jaws. Jaw length 2" (5.1cm).

<u>Item Number</u>	<u>Description</u>
MDS1437757	Overall length $10\frac{3}{4}$ " (27.3cm)



## DEBAKEY CURVED CLAMP

Strongly curved jaws, length  $2\frac{3}{8}$ " (6cm).

<u>Item Number</u>	<u>Description</u>
MDS1438341	Overall length $10\frac{1}{4}$ " (26cm)



## DEBAKEY-BAHNSON CURVED CLAMPS

<u>Item Number</u>	<u>Description</u>
MDS1438342	Curved jaws, length $2\frac{1}{2}$ " (6.4cm), overall length $10\frac{3}{4}$ " (27.3cm)
MDS1438343	Slightly curved jaws, length 3" (7.6cm), overall length $11\frac{1}{4}$ " (28.6cm)



## DEBAKEY CURVED CLAMP

Acutely curved jaws, length  $3\frac{3}{8}$ " (8.6cm).

<u>Item Number</u>	<u>Description</u>
MDS1438351	Overall length $10\frac{1}{2}$ " (26.7cm)

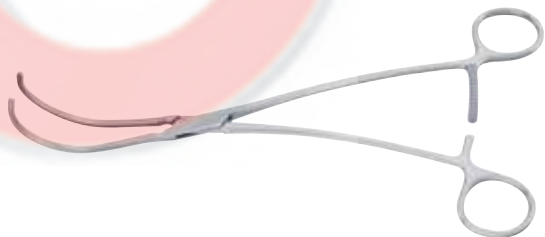

## DEBAKEY HYPOGASTRIC CLAMP

<u>Item Number</u>	<u>Description</u>
MDS1438451	Overall length $8\frac{1}{2}$ " (21.5cm)





## WYLIE "J" CLAMPS

Acutely curved jaws, length 1<sup>1</sup>/<sub>4</sub>" (3.3cm), depth 1" (2.5cm).

Item Number	Description
MDS1438561	Overall length 8 <sup>1</sup> / <sub>2</sub> " (21.6cm)
MDS1438565	Overall length 9 <sup>1</sup> / <sub>8</sub> " (23.2cm)



## WYLIE HYPOGASTRIC CLAMP

Item Number	Description
MDS1838569	Overall length 9 <sup>1</sup> / <sub>2</sub> " (24.1cm)



## DALE FEMORAL-POPLITEAL CLAMPS

Item Number	Description
MDS1327317	Small, jaw length 1/2" (1.5cm), overall length 6 <sup>7</sup> / <sub>8</sub> " (17.5cm)
MDS1327318	Medium, jaw length 3/4" (2cm), overall length 7" (17.8cm)
MDS1327319	Large, jaw length 1" (2.5cm), overall length 7 <sup>1</sup> / <sub>8</sub> " (18.1cm)

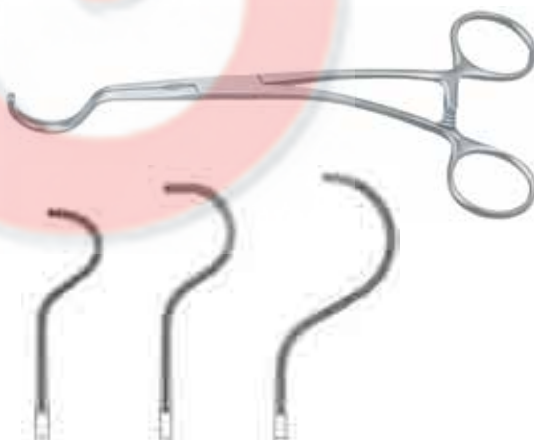

## CHERRY SUPRACELIAC CLAMP

Handle angled 60°. 2 x 3 teeth. Curved jaws, length 5<sup>3</sup>/<sub>4</sub>" (14.6cm).

Item Number	Description
MDS1438571	Overall length 12 <sup>1</sup> / <sub>2</sub> " (31.7cm)



## HENDREN CARDIOVASCULAR CLAMPS

Fine. Cooley jaws calibrated in 5mm increments.  
Overall length 6<sup>1</sup>/<sub>4</sub>" (15.9cm).

<u>Item Number</u>	<u>Description</u>
MDS1437633	Jaw base 12mm
MDS1437635	Jaw base 18mm
MDS1437637	Jaw base 24mm



## GLOVER CURVED FORCEPS

Curved jaws, length 1<sup>3</sup>/<sub>4</sub>" (4.5cm), depth 7mm.

<u>Item Number</u>	<u>Description</u>
MDS1438226	Overall length 8 <sup>1</sup> / <sub>4</sub> " (21cm)

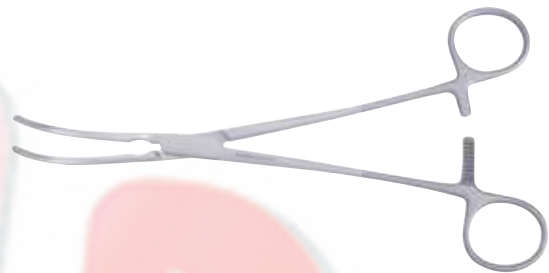

## GLOVER CURVED CLAMPS

Curved Cooley jaws.

<u>Item Number</u>	<u>Description</u>
MDS1437461	Jaw length 2" (5.1cm), overall length 8 <sup>1</sup> / <sub>2</sub> " (21.6cm)
MDS1437463	Jaw length 2 <sup>3</sup> / <sub>4</sub> " (7cm), overall length 9 <sup>3</sup> / <sub>4</sub> " (24.8cm)



## GLOVER SPOON ANASTOMOSIS CLAMP

Jaw length 2<sup>7</sup>/<sub>16</sub>" (6.2cm).

<u>Item Number</u>	<u>Description</u>
MDS1437451	Overall length 8 <sup>1</sup> / <sub>2</sub> " (21.6cm)



## GLOVER SPOON-SHAPED FORCEPS

<u>Item Number</u>	<u>Description</u>
MDS1316121	Curved jaw, length 1 <sup>5</sup> / <sub>8</sub> " (4cm), depth 7mm, overall length 8 <sup>1</sup> / <sub>2</sub> " (21.6cm)
MDS1437220	Curved jaw, length 1 <sup>7</sup> / <sub>8</sub> " (4.8cm), depth 8mm, overall length 9 <sup>1</sup> / <sub>2</sub> " (24.1cm)



## HARKEN CLAMPS

Curved jaw with cross-serrations.

<u>Item Number</u>	<u>Description</u>
MDS1437573	Jaw length 2 <sup>7</sup> / <sub>8</sub> " (7.4cm), overall length 9 <sup>1</sup> / <sub>2</sub> " (24.3cm)
MDS1437575	Jaw length 2 <sup>3</sup> / <sub>8</sub> " (6cm), overall length 9 <sup>3</sup> / <sub>8</sub> " (23.8cm)

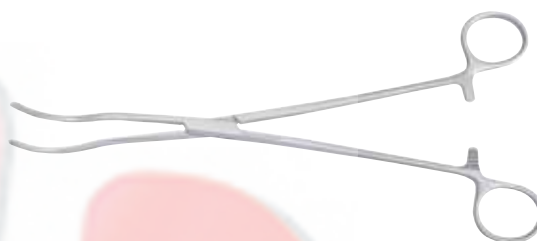

## HARKEN CLAMPS

Curved jaws with Cooley teeth.  
Overall length 10" (25.4cm).

<u>Item Number</u>	<u>Description</u>
MDS1437584	Jaw length 1 <sup>7</sup> / <sub>8</sub> " (4.8cm)
MDS1437585	Jaw length 2 <sup>1</sup> / <sub>2</sub> " (6.4cm)

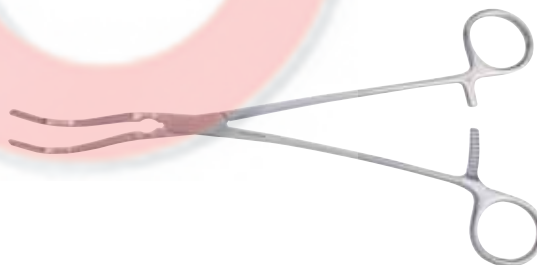

## COOLEY BRONCHUS CLAMP

Designed with Cooley jaws.  
Jaw length 2" (5.1cm).

<u>Item Number</u>	<u>Description</u>
MDS1437511	Overall length 8 <sup>1</sup> / <sub>4</sub> " (21cm)



## JAVID CAROTID ARTERY BYPASS SHUNT CLAMPS

Item Number	Description
MDS1334318	Angled jaws close to approximately 4mm diameter ring at distal tip, overall length 6 $\frac{1}{4}$ " (15.9cm)
MDS1334319	Angled jaws close to approximately 6mm diameter ring at distal tip, overall length 7" (17.8cm)



## FOGARTY CLAMPS

For vascular use. Jaws accept 33mm inserts.

Item Number	Description
MDS1456131	Straight, overall length 6 $\frac{1}{2}$ " (16.5cm)
MDS1456136	Angled, overall length 4 $\frac{5}{8}$ " (11.8cm)

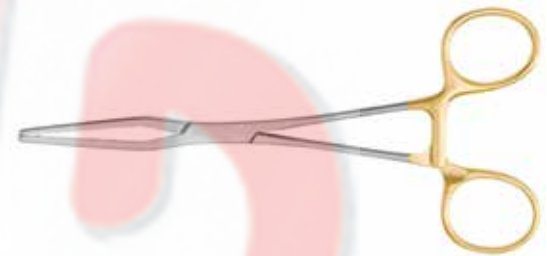

## FOGARTY CLAMPS

Item Number	Description
MDS1456141	Straight, jaws accept 61mm inserts, overall length 11 $\frac{1}{2}$ " (29.2cm)
MDS1456151	Angled, jaws accept 61mm inserts, overall length 8 $\frac{3}{4}$ " (22.2cm)
MDS1456156	Angled, jaws accept 61mm inserts, overall length 8 $\frac{1}{2}$ " (21.6cm)
MDS1456161	Angled, jaws accept 86mm inserts, overall length 9 $\frac{1}{4}$ " (23.5cm)

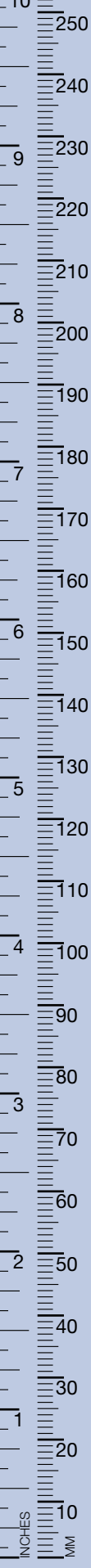

## SPRING CLIP APPLICATOR FORCEPS

Item Number	Description
MDS1456221	For use with 6mm Fogarty® spring clips, overall length 7 <sup>1</sup> / <sub>4</sub> " (18.4cm)

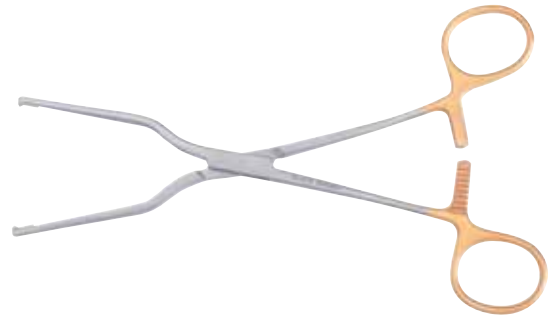

## FOGARTY FORCEPS

Jaws accept 86mm inserts.

Item Number	Description
MDS1456166	Straight, overall length 12 <sup>1</sup> / <sub>4</sub> " (31.1cm)



## RUMEL CARDIOVASCULAR TOURNIQUET

Item Number	Description
-------------	-------------

### Set screw mechanism.

MDS1466711	Working length 8" (20.3cm), stylet length 11 <sup>1</sup> / <sub>8</sub> " (28.3cm), overall length 13 <sup>5</sup> / <sub>8</sub> " (34.6cm)
MDS1467002	Eyed obturator for MDS1466711, overall length 11 <sup>1</sup> / <sub>8</sub> " (28.3cm)



### Ratchet mechanism for adjustment.

MDS1466716	Adult, working length 8" (20.3cm), stylet length 10 <sup>7</sup> / <sub>8</sub> " (27.6cm), overall length 13 <sup>1</sup> / <sub>2</sub> " (34.3cm)
MDS14667162	Eyed stylet for MDS1466716, overall length 10 <sup>7</sup> / <sub>8</sub> " (27.6cm)
MDS1466717	Pediatric, working length 6 <sup>7</sup> / <sub>8</sub> " (17.5cm), Stylet length 9 <sup>1</sup> / <sub>2</sub> " (24.1cm), overall length 12 <sup>3</sup> / <sub>8</sub> " (31.4cm)
MDS14667172	Eyed stylet for MDS1466717, overall length 9 <sup>1</sup> / <sub>2</sub> " (24.1cm)

## COOLEY CORONARY DILATORS

Malleable shaft with rounded blunt tip. Aluminum handle.  
Mirror finish. Overall length 5" (12.7cm).

Item Number	Description
MDS2040405	Tip size 0.5mm
MDS2040410	Tip size 1mm
MDS2040415	Tip size 1.5mm
MDS2040420	Tip size 2mm
MDS2040425	Tip size 2.5mm
MDS2040430	Tip size 3mm



## DEBAKEY VASCULAR DILATORS

Overall length 7 1/2" (19cm).

Item Number	Description
MDS2043005	Tip size 0.5mm
MDS2043010	Tip size 1mm
MDS2043015	Tip size 1.5mm
MDS2043020	Tip size 2mm
MDS2043025	Tip size 2.5mm
MDS2043030	Tip size 3mm
MDS2043035	Tip size 3.5mm
MDS2043040	Tip size 4mm
MDS2043045	Tip size 4.5mm
MDS2043050	Tip size 5mm
MDS2043070	Tip size 7mm
MDS2043090	Tip size 9mm



## GARRETT VASCULAR DILATORS

Thin shaft with elongated oval tip.

Overall Length 5 1/2" (14cm)	Overall Length 8 1/8" (20.6cm)	Tip Size
MDS2040001	MDS2040201	1mm
MDS2040015	MDS2040215	1.5mm
MDS2040020	MDS2040220	2mm
MDS2040025	MDS2040225	2.5mm
MDS2040030	MDS2040230	3mm
MDS2040035	MDS2040235	3.5mm
MDS2040040	MDS2040240	4mm
MDS2040045	MDS2040245	4.5mm
MDS2040050	MDS2040250	5mm
MDS2040210	Holder for 5 1/2" (14cm) dilators	
MDS2040210	Holder for 8 1/8" (20.6cm) dilators	

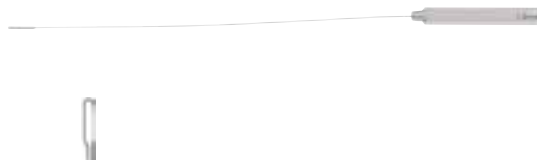

## LEATHERR ANTEGRADE/RETROGRADE VALVULOTOME

Mirror finish.

Item Number	Description
MDS2059792	Cutting surface on leading edge, overall length 7" (17.8cm)
MDS2059791	Cutting surface on leading edge, overall Length 9" (22.9cm)
MDS20597912	Blade on inside edge of tip, tip 2.9mm, overall length 13" (33cm)



## COOLEY VASCULAR SUCTION TUBE

Round, perforated end 7.5mm O.D.

Item Number	Description
MDS0417530	Working length 7" (17.8cm), overall length 12" (30.5cm)





## BAYLOR INTRACARDIAC SUMP TUBE

Angled 45°. Medium. Tip 5mm O.D.

<u>Item Number</u>	<u>Description</u>
MDS0419184	Overall length 3½" (8.9cm)



## BAYLOR SUMP TUBES

Angled 90°.

<u>Item Number</u>	<u>Description</u>
MDS0419182	Small, tip 4mm O.D. length 1¼" (3.1cm), depth 1¼" (3.1cm)
MDS0419185	Medium, tip 5mm O.D. length 2¼" (5.7cm), depth 2¼" (5.7cm)
MDS0419187	Large, tip 6.4mm O.D. length 2½" (6.4cm), depth 27/16" (6.2cm)



## GRAFTING SUCTION TUBES

Overall length 9½" (24.1cm).

<u>Item Number</u>	<u>Description</u>
MDS0419341	Tip 3mm
MDS0419353	Tip 4mm



## PEDIATRIC SUCTION TUBES

No 2, perforated, removable tip.

<u>Item Number</u>	<u>Description</u>
MDS0414411	Working length 2½" (6.4cm), overall length 7½" (19cm)



## HEPARIN NEEDLES

13GA. Luer lock. Mirror finish.

<u>Item Number</u>	<u>Description</u>
MDS0419191	Overall length 2" (5.1cm)
MDS0419194	Overall length 3" (7.6cm)



## ZANGER HEPARIN CANNULA

Malleable. Luer lock. Tip 4mm.

<u>Item Number</u>	<u>Description</u>
MDS0499195	Overall length 2 1/2" (6.3cm)



## HEPARIN CANNULA

Malleable. Tip 1.5mm.

<u>Item Number</u>	<u>Description</u>
MDS0499196	Overall length 2 1/8" (5.4cm)



## CHEST TUBE PASSERS

<u>Item Number</u>	<u>Description</u>
MDS1615296	Without ratchet, overall length 9 3/4" (24.8cm)
MDS1615290	Without ratchet, overall length 14" (35.6cm)



### COOLEY NEONATAL VASCULAR CLAMP

Straight shanks. Straight jaws, length 1 1/2" (3.8cm).

<u>Item Number</u>	<u>Description</u>
MDS7061112	Overall length 5" (12.7cm)



### COOLEY NEONATAL VASCULAR CLAMP

Angled shanks. Straight jaws, length 1 1/2" (3.8cm).

<u>Item Number</u>	<u>Description</u>
MDS7061113	Overall length 5" (12.7cm)



### COOLEY NEONATAL VASCULAR CLAMP

Curved shanks. Angled jaws, length 1 1/2" (3.8cm).

<u>Item Number</u>	<u>Description</u>
MDS7061114	Overall length 4 7/8" (12.4cm)



### COOLEY NEONATAL VASCULAR CLAMP

Straight shanks. Fully curved jaws, length 1" (2.5cm).

<u>Item Number</u>	<u>Description</u>
MDS7061115	Overall length 4 1/2" (11.4cm)



### COOLEY NEONATAL VASCULAR CLAMP

Straight shanks. Partial occlusion jaws,  
length 1 $\frac{1}{8}$ " (2.9cm).

<u>Item Number</u>	<u>Description</u>
MDS7061116	Overall length 4 $\frac{5}{8}$ " (11.7cm)



### COOLEY NEONATAL VASCULAR CLAMP

Curved shanks. Angled jaws, length 1 $\frac{3}{4}$ " (4.4cm).

<u>Item Number</u>	<u>Description</u>
MDS7061117	Overall length 5" (12.7cm)



### COOLEY VASCULAR FORCEPS

Fine jaws.

<u>Item Number</u>	<u>Description</u>
MDS7061110	Overall length 5 $\frac{1}{2}$ " (14cm)



# Ear/Endaural



König

## GRUBER EAR SPECULA

Oval tip. Chrome plated.

Item Number	Description
MDS0314846	Infant, small, 2mm x 2.5mm I.D.
MDS0314851	Infant, medium, 2.5mm x 3mm I.D.
MDS0314826	Infant, large, 3mm x 4mm I.D.
MDS1610965	Standard, small, 3mm x 4mm I.D.
MDS1610966	Standard, medium, 4mm x 5mm I.D.
MDS1610967	Standard, large, 5mm x 6mm I.D.



## FARRIOR EAR SPECULA

Glare-reducing interior surface. Oval tip.

Flat tip	Tip angled 20°	Internal Diameter
MDS4496230	MDS4496330	3mm x 4mm
MDS4496240	MDS4496340	4mm x 5mm
MDS4496245	MDS4496345	4.5mm x 5.5mm
MDS4496250	MDS4496350	5mm x 6mm
MDS4496255	MDS4496355	5.5mm x 6.5mm
MDS4496260	MDS4496360	6mm x 7mm
MDS4496265	MDS4496365	6.5mm x 7.5mm
MDS4496270	MDS4496370	7mm x 8mm
MDS4496275	MDS4496375	7.5mm x 8.5mm



## BOUCHERON EAR SPECULA

Round tip. Chrome plated.

Item Number	Description
MDS4401830	3mm I.D.
MDS4401840	4mm I.D.
MDS4401850	5mm I.D.
MDS4401860	6mm I.D.
MDS4401870	7mm I.D.
MDS4401880	8mm I.D.
MDS4401890	9mm I.D.

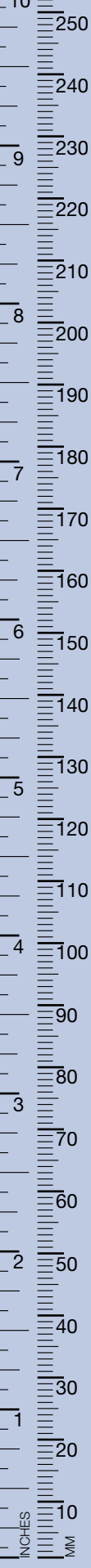

## LATHBURY COTTON APPLICATORS

Nickel-silver alloy. Overall length 6" (15.2cm).

<u>Item Number</u>	<u>Description</u>
MDS2022711	Triangular tip, light model
MDS2022709	Twisted tip, regular model



## LILLIE ATTIC HOOKS

Tip length 4mm. Overall length 7" (17.4cm).

<u>Item Number</u>	<u>Description</u>
MDS0346939	Angled 90°
MDS0368151	Angled 50°



## ALLPORT-BABCOCK MASTOID SEARCHER

<u>Item Number</u>	<u>Description</u>
MDS3658116	Overall length 6 $\frac{1}{2}$ " (16.5cm)

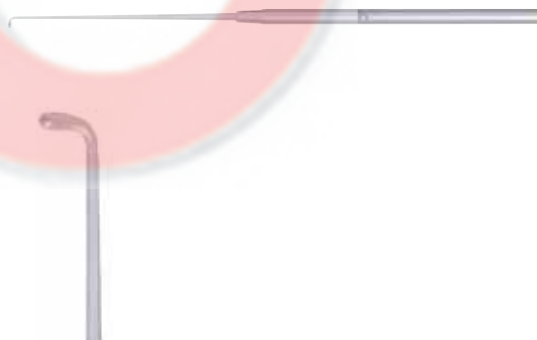

## ROSEN PROBE

<u>Item Number</u>	<u>Description</u>
MDS0397459	Overall length 6 $\frac{3}{8}$ " (16.2cm)





## BUCK EAR CURETTES

Slightly angled tip. Overall length  $5\frac{7}{8}$ " (15cm).

<u>Item Number</u>	<u>Description</u>
MDS4411600	Sharp. Size 00, 2mm O.D.
MDS4411700	Sharp. Size 0, 2.3mm O.D.
MDS4411701	Sharp. Size 1, 3mm O.D.
MDS4411702	Sharp. Size 2, 3.6mm O.D.
MDS4411703	Sharp. Size 3, 4mm O.D.
MDS4411400	Blunt. Size 00, 2mm O.D.
MDS4411500	Blunt. Size 0, 2.3mm O.D.
MDS4411501	Blunt. Size 1, 3mm O.D.
MDS4411502	Blunt. Size 2, 3.6mm O.D.
MDS4411503	Blunt. Size 3, 4mm O.D.



## BILLEAU EAR LOOPS

Oval, flexible loop. Overall length  $6\frac{1}{2}$ " (16.5cm).

<u>Item Number</u>	<u>Description</u>
MDS4418001	Small, 5.4mm x 3.9mm wide
MDS4418002	Medium, 7.7mm x 5.2mm wide
MDS4418003	Large, 9.1mm x 5.7mm wide



## HOUSE CURETTES

Double-ended. 2mm and 2.5mm wide oval cups.  
Overall length  $6\frac{1}{2}$ " (16.7cm).

<u>Item Number</u>	<u>Description</u>
MDS44676402	Slight angle
MDS4464802	Strong angle



## HOUSE STAPES CURETTES

2mm and 2.5mm cups.

<u>Item Number</u>	<u>Description</u>
MDS4476402	Overall length 6" (15.0cm)



## PAPARELLA ANGLED RING CURETTE

No. 12. Angled 20°. Blunt 2mm O.D. ring.

Item Number	Description
MDS4464912	Overall length 6½" (16.5cm)



## LEMPERT CURETTES

Oval cup. Overall length 8" (20cm).

Item Number	Description
MDS3249060	Fine. Size 6/0, cup 2.3mm x 1.5mm wide
MDS3249050	Fine. Size 5/0, cup 2.5mm x 1.8mm wide
MDS3249040	Size 0000, cup 3.2mm x 2.1mm wide
MDS3249030	Size 000, cup 3.3mm x 2.4mm wide
MDS3249020	Size 00, cup 4.3mm x 2.7mm wide
MDS3249010	Size 0, cup 4.6mm x 3mm wide
MDS3249001	Size 1, cup 5.1mm x 3.6mm wide
MDS3249002	Size 2, cup 6mm x 4mm wide.



## SPRATT MASTOID CURETTES

Oval cup. Overall length 6½" (16.5cm).

Item Number	Description
MDS3247497	Size 000, cup 3.2mm wide
MDS3247498	Size 00, cup 3.4mm wide
MDS3247500	Size 0, cup 3.7mm wide
MDS3247501	Size 1, cup 4.7mm wide
MDS3247502	Size 2, cup 5.7mm wide
MDS3247503	Size 3, cup 7mm wide
MDS3247504	Size 4, cup 8.4mm wide
MDS3247505	Size 5, cup 8.9mm wide
MDS3247506	Size 6, cup 10.2mm wide



## GUILFORD-WRIGHT MICRO BONE CURETTES

Overall length 5¼" (13.5cm).

Item Number	Description
MDS3246112	1mm cup, slightly angled
MDS3246115	1.5mm cup, slightly angled
MDS3246118	2mm cup, slightly angled



## SEXTON EAR KNIFE

Straight. Blade 10mm x 1.5mm wide.

<u>Item Number</u>	<u>Description</u>
MDS4416218	Overall length 7 $\frac{1}{4}$ " (18.4cm)



## GUILFORD-WRIGHT DOUBLE-EDGED SICKLE KNIFE

Double-edged blade, length 7mm.

<u>Item Number</u>	<u>Description</u>
MDS4416614	Overall length 5 $\frac{1}{2}$ " (14cm)



## TABB DOUBLE-ENDED FLAP KNIFE

Designed to perform the stapes incision.  
Blades 2mm x 3mm wide, angled 20° and 45°.

<u>Item Number</u>	<u>Description</u>
MDS0397936	Overall length 6 $\frac{3}{8}$ " (16.3cm)



## GUILFORD-WRIGHT FLAP KNIFE

Blade 2mm x 5mm wide.

<u>Item Number</u>	<u>Description</u>
MDS0396156	Overall length 6 $\frac{5}{8}$ " (16.8cm)



## SCHUKNECHT ROLLER KNIVES

Overall length 7½" (19.2cm).

<u>Item Number</u>	<u>Description</u>
MDS4470101	3mm vertical round blade
MDS4470102	3mm horizontal round blade



## SCHUKNECHT SICKLE KNIFE

7mm single-edged blade, angled shaft.

<u>Item Number</u>	<u>Description</u>
MDS4470315	Overall length 6¼" (15.9cm)



## TABB MYRINGOPLASTY KNIVES

Double-ended. Overall length 6¼" (15.9cm).

<u>Item Number</u>	<u>Description</u>
MDS0397916	1mm wide blade angled 90° and 2mm wide blade angled 120°
MDS0397926	1.3mm wide blades angled 90° and 115°
MDS0397937	1.1mm wide blades angled 25° and 45°

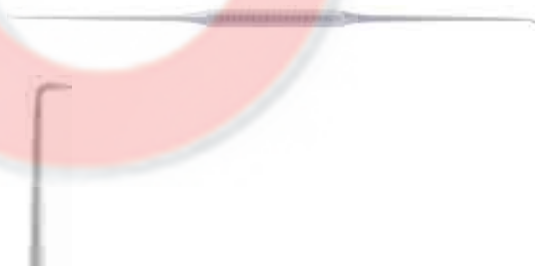

## SHEEHY ROUND KNIVES

"Weapon-style." Overall length 6½" (16.5cm).

<u>Item Number</u>	<u>Description</u>
MDS0396421	Small, cup 2mm wide
MDS0396426	Large, cup 2.5mm wide



## HOUSE KNIVES

Overall length 6½" (16.5cm).

<u>Item Number</u>	<u>Description</u>
MDS0374299	Sickle, No. 1
MDS0374294	Lancet, No. 2

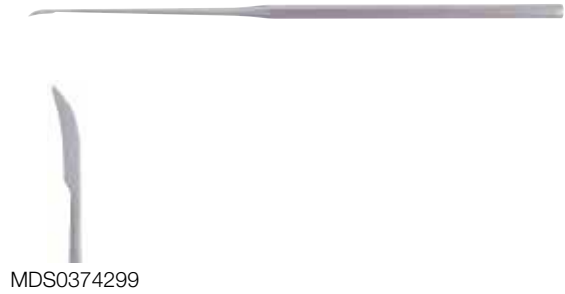

## HOUSE INCUDOSTAPEDIAL JOINT KNIFE

Blade .75mm, angled 60°.

<u>Item Number</u>	<u>Description</u>
MDS4474516	Overall length 6½" (16.5cm)



## MCCABE FLAP KNIFE DISSECTOR

Double-ended, with 2mm x 3.5mm wide blades angled 20° and 45°. Square, hollow handle.

<u>Item Number</u>	<u>Description</u>
MDS0302591	Overall length 7¼" (18.5cm)



## PAPARELLA CANAL KNIVES

Overall length 6⅝" (17cm).

<u>Item Number</u>	<u>Description</u>
MDS0397116	Handle with replaceable straight blade
MDS0397126	Handle with replaceable angled blade
MDS0397116R	Replacement blade for MDS0397116 (straight)
MDS0397126R	Replacement blade for MDS0397126 (angled)

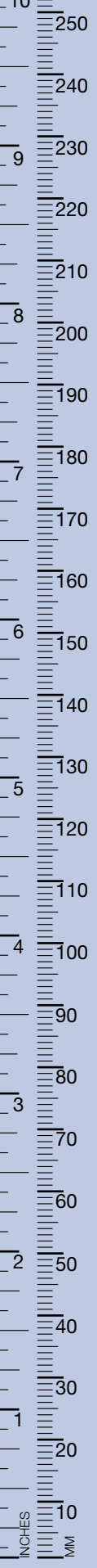

## PAPARELLA SICKLE KNIVES

Overall length 6½" (16.5cm).

<u>Item Number</u>	<u>Description</u>
MDS0397101	1mm x 4mm long
MDS0397106	Blade 1mm x 4mm wide



## AUSTIN SICKLE KNIFE

Sickle blade.

<u>Item Number</u>	<u>Description</u>
MDS0395766	3mm blade, overall length 6¼" (15.9cm)



## SHAMBAUGH PALPATING NEEDLES

Overall length 6⅛" (15.7cm).

<u>Item Number</u>	<u>Description</u>
MDS0397661	Straight, fine
MDS0397666	Straight, super-fine



## HOUSE-ROSEN NEEDLES

Slightly curved. Overall length 6½" (16.5cm).

<u>Item Number</u>	<u>Description</u>
MDS4473715	Slightly dull tip
MDS4473714	Sharp



## HOUSE-BARBARA PICK (SHATTERING NEEDLE)

Straight tip. Malleable shaft.

<u>Item Number</u>	<u>Description</u>
MDS4471015	Overall length 6½" (16.5cm)



## SCHUKNECHT NEEDLE

Straight, rigid needle tip, angled shaft.

<u>Item Number</u>	<u>Description</u>
MDS4472116	Overall length 6¼" (15.9cm)



## ROSEN SUCTION TUBES

Angled. With obturator. Working length 60mm.  
Overall length 3⅜" (8.5cm).

<u>Item Number</u>	<u>Description</u>
MDS0344014	14GA
MDS0344016	16GA
MDS0344018	18GA
MDS0344020	20GA
MDS0344022	22GA
MDS0344024	24GA



## GUILFORD-WRIGHT SUCTION TUBES

Overall length 4" (10.5cm).

<u>Item Number</u>	<u>Description</u>
MDS0382118	18GA
MDS0382120	20GA
MDS0382122	22GA
MDS0382124	24GA





## SCHUKNECHT SUCTION TIPS

Working length 4½" (11.4cm). Working length 78mm.

<u>Item Number</u>	<u>Description</u>
MDS0384420	20GA
MDS0384424	24GA



## BARON SUCTION TUBES

<u>Item Number</u>	<u>Description</u>
MDS0440310	3Fr working length 3" (7.6cm)
MDS4410203	3Fr working length 4" (10.2cm)
MDS0440315	5Fr working length 3" (7.6cm)
MDS4410205	5Fr working length 4" (10.2cm)
MDS0440320	7Fr working length 3" (7.6cm)
MDS0440317	7Fr working length 4" (10.2cm)



## HOUSE SUCTION-IRRIGATORS

Working length 3⅝" (9.2cm).

<u>Item Number</u>	<u>Description</u>
MDS0440109	3Fr, working length 2¾" (7cm)
MDS0440113	3Fr, working length 3⅝" (9.2cm)
MDS0440112	5Fr, working length 2¾" (7cm)
MDS0440115	5Fr, working length 3⅝" (9.2cm)
MDS0440215	7Fr, working length 2¾" (7cm)
MDS0440117	7Fr, working length 3⅝" (9.2cm)
MDS0440118	8Fr, working length 2¾" (7cm)
MDS0440125	10Fr, working length 2¾" (7cm)
MDS0440130	12Fr, working length 2¾" (7cm)
MDS0440145	14Fr, working length 2¾" (7cm)



## FRAZIER SUCTION TUBES & OBTURATORS

Angled, with finger valve and obturator.  
Working length  $3\frac{7}{8}$ " (9.8cm).

<u>Item Number</u>	<u>Description</u>
MDS4029506	6Fr, tube
MDS4029516	Obturator, for 6Fr tube MDS4029506
MDS4029507	7Fr, tube
MDS4029517	Obturator, for 7Fr tube MDS4029507
MDS4029508	8Fr, tube
MDS4029518	Obturator, for 8Fr tube MDS4029508
MDS4029509	9Fr, tube
MDS4029519	Obturator, for 9Fr tube MDS4029509
MDS4029510	10Fr, tube
MDS4029520	Obturator, for 10Fr tube MDS4029510
MDS4029511	11Fr, tube
MDS4029531	Obturator, for 11Fr tube MDS4029511
MDS4029512	12Fr, tube
MDS4029522	Obturator, for 12Fr tube MDS4029512



## ANTHONY MASTOID SUCTION TUBES

Straight with tubing connection.  
Overall length  $6\frac{1}{8}$ " (15.6cm).

<u>Item Number</u>	<u>Description</u>
MDS4006660	2mm I.D.
MDS4006661	3mm I.D.



## HOUSE SUCTION ADAPTER

For House suction tubes.

<u>Item Number</u>	<u>Description</u>
MDS0385230	Short



### PAPARELLA PICKS

Tip 1mm wide. Overall length 6½" (16.5cm).

Item Number	Description
MDS0397211	Right
MDS0397217	Left



### HOUGH FOOT PLATE PICKS

Overall length 5⅞" (14.9cm).

Item Number	Description
MDS0396206	Slightly curved tip



### AUSTIN PICKS

Sharp pointed tip. Overall length 6⅜" (16.2cm).

Item Number	Description
MDS0395746	Tip length 1mm, angled 25°
MDS0395756	Tip length 1mm, angled 90°
MDS0395751	Tip length 1mm, angled 45°
MDS0373549	Tip length 3mm, angled 90°



### SHEA OBLIQUE HOOK

Slightly blunt tip, 0.5mm wide.  
Hook angled 90°, length 3mm.

Item Number	Description
MDS4400316	Overall length 6⅛" (15.8cm)

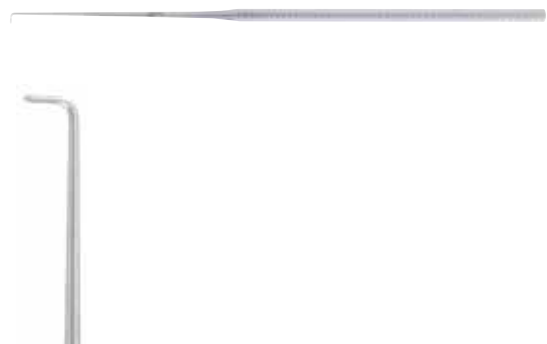

## SCHUKNECHT FOOT PLATE HOOKS

Angled shaft. Overall length  $6\frac{5}{16}$ " (16.2cm).

<u>Item Number</u>	<u>Description</u>
MDS0397521	Anterior 0.4mm tip, bent forward
MDS0397526	Anterior 0.7mm tip, bent forward
MDS0397531	Posterior 0.4mm tip, bent downward
MDS0397536	Posterior 0.7mm tip, bent downward

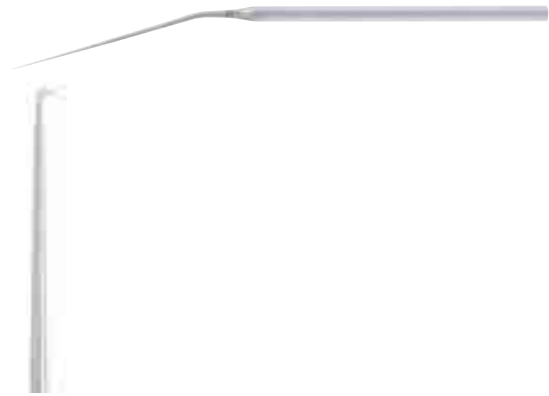

## HOUGH-SAUNDERS HOOK

Tip 1mm, angled 90°.

<u>Item Number</u>	<u>Description</u>
MDS0397156	Overall length $6\frac{1}{2}$ " (16.5cm)



## HOUGH EXCAVATORS

"Whirlybird-style." Overall length  $5\frac{7}{8}$ " (15cm).

<u>Item Number</u>	<u>Description</u>
MDS0396266	Curved left, blade 1mm wide, length 5mm
MDS0396276	Curved left, blade 0.7mm wide, length 5mm
MDS0396246	Curved right, blade 1mm wide, length 5mm
MDS0396256	Curved right, blade 0.7mm wide, length 5mm



## DERLACKI MOBILIZER

Angled tip with serrated end.

<u>Item Number</u>	<u>Description</u>
MDS0397671	Overall length $6\frac{3}{16}$ " (15.8cm)



## HOUSE STAPES ELEVATORS

“Gimmick-style.” Angled tip, 12mm x 1mm wide.  
Overall length 6½" (16.5cm).

<u>Item Number</u>	<u>Description</u>
MDS0374259	Regular model



## GUILFORD-WRIGHT DUCKBILL ELEVATORS

<u>Item Number</u>	<u>Description</u>
MDS0396116	Curved, blade 3mm wide, overall length 5 <sup>5</sup> / <sub>8</sub> " (14.3cm)
MDS0396111	Curved, blade 4mm wide, overall length 5 <sup>5</sup> / <sub>8</sub> " (14.3cm)



## AUSTIN DUCKBILL ELEVATOR

Slightly curved blade, 2mm wide.

<u>Item Number</u>	<u>Description</u>
MDS0373599	Overall length 6¼" (15.9cm)



## PAPARELLA DUCKBILL ELEVATOR

Blade 3.5mm wide.

<u>Item Number</u>	<u>Description</u>
MDS0397221	Overall length 6½" (16.5cm)



## LEMPERT HEAVY ELEVATOR

Blade 7mm wide.

<u>Item Number</u>	<u>Description</u>
MDS4480705	Overall length 7¼" (18.5cm)



## HOUSE MEASURING RODS

Overall length 6½" (16.5cm).

<u>Item Number</u>	<u>Description</u>
MDS4476635	3.5mm
MDS4476640	4mm
MDS4476645	4.5mm
MDS4476650	5mm



## MCCABE PERFORATION RASPS

Overall length 6⅛" (15.8cm).

<u>Item Number</u>	<u>Description</u>
MDS0396891	Blade angled 45°
MDS0396896	Blade angled 120°

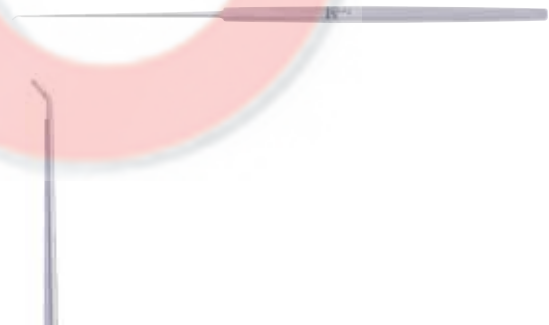

## AUSTIN STRUT CALIPER AND MEASURING GAUGE

<u>Item Number</u>	<u>Description</u>
MDS0395791	First prong at 3.5mm, groove at 4mm, and second prong at 4.5mm, overall length 6¼" (15.9cm)



## CRABTREE DISSECTORS

"Jimmy." Malleable shaft. Overall length 6 $\frac{1}{2}$ " (16.5cm).

<u>Item Number</u>	<u>Description</u>
MDS0396516	Small tip, blade 1.3mm
MDS0396501	Large tip, blade 2mm



## HARTMANN EAR FORCEPS

Serrated, cupped jaws.

<u>Item Number</u>	<u>Description</u>
MDS0370234	Extremely fine, working length 2" (5.1cm)
MDS4616112	Light pattern, working length 2 $\frac{3}{8}$ " (6cm)
MDS4616114	Regular pattern, working length 2 $\frac{3}{16}$ " (5.5cm)

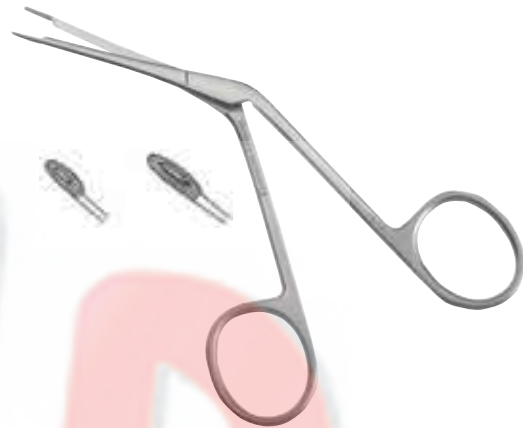

## NOYES EAR FORCEPS

Overall length 5 $\frac{1}{2}$ " (14cm).

<u>Item Number</u>	<u>Description</u>
MDS0370519	Alligator-type, fine, fine, serrated grasping jaws
MDS4426308	1 x 2 teeth with serrated jaws





## WULLSTEIN EAR FORCEPS

Working length 3<sup>1</sup>/<sub>8</sub>" (7.9cm).

<u>Item Number</u>	<u>Description</u>
MDS4441645	Heavy, serrated jaws
MDS4441809	Fine, cup-shaped jaws, 4.5mm x 0.9mm wide oval cup



## HEERMANN ALLIGATOR EAR FORCEPS

Extremely fine. Straight jaws.

<u>Item Number</u>	<u>Description</u>
MDS4451000	Working length 4 <sup>5</sup> / <sub>8</sub> " (11.7cm)



## HOUSE STRUT FORCEPS

Fine, smooth jaws.

<u>Item Number</u>	<u>Description</u>
MDS0371004	Working length 3 <sup>1</sup> / <sub>8</sub> " (7.9cm)



## HOUSE ALLIGATOR FORCEPS

Fine, serrated jaws open horizontally to right.

<u>Item Number</u>	<u>Description</u>
MDS4499400	Working length 3 <sup>1</sup> / <sub>8</sub> " (7.9cm)



## HOUSE ALLIGATOR GRASPING FORCEPS

Fine, serrated. Jaws 6mm.

<u>Item Number</u>	<u>Description</u>
MDS4499401	Working length 3 $\frac{1}{8}$ " (7.9cm)



## CUP FORCEPS

Working length 4" (10cm).

<u>Item Number</u>	<u>Description</u>
MDS4446201	Cup 1mm
MDS4446202	Cup 2mm
MDS4446203	Cup 3mm



## HOUGH ALLIGATOR FORCEPS

Fine, serrated side-grasping jaws.  
Working length 3 $\frac{1}{8}$ " (7.9cm).

<u>Item Number</u>	<u>Description</u>
MDS0393291	Angled right
MDS0393292	Angled left



## WULLSTEIN TYPE TYMPANOPLASTY FORCEPS

Fine, oval cup-shaped jaws. Working length 2 $\frac{3}{4}$ " (7cm).

<u>Item Number</u>	<u>Description</u>
MDS4499306	Angled upward 90°
MDS4499307	Angled upward 35°



## HOUSE CUP FORCEPS

Fine oval cup jaws, .6mm x 1mm cup.

<u>Item Number</u>	<u>Description</u>
MDS4499308	Working length 3" (7.6cm)



## HARTMANN-HERZFELD EAR PUNCH FORCEPS

Round, cup-shaped jaws. Working length 3<sup>13</sup>/<sub>16</sub>" (7.1cm).

<u>Item Number</u>	<u>Description</u>
MDS4426720	2mm
MDS4426730	3mm

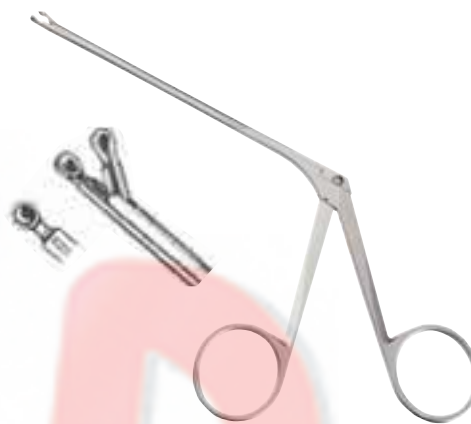

## STRUEMPPEL EAR PUNCH FORCEPS

Fenestrated oval cup jaws, 2.5mm x 6mm.

<u>Item Number</u>	<u>Description</u>
MDS4427108	Working length 3" (7.6cm)



## HOUSE-WULLSTEIN OVAL CUP FORCEPS

Working length 2<sup>3</sup>/<sub>16</sub>" (7.2cm). .6mm x 1mm oval cups.

<u>Item Number</u>	<u>Description</u>
MDS4436301	Jaws bent right
MDS4436302	Jaws bent left



### BELLUCCI ALLIGATOR SCISSORS

7mm blades.

<u>Item Number</u>	<u>Description</u>
MDS4431041	Working length 3" (7.6cm), overall length 5 <sup>3</sup> / <sub>8</sub> " (13.7cm)



### WULLSTEIN EAR SCISSORS

Fine blades, length 5mm. Working length 4<sup>1</sup>/<sub>2</sub>" (11.4cm).

<u>Item Number</u>	<u>Description</u>
MDS4431140	Curved right
MDS4441000	Straight
MDS4431145	Curved left

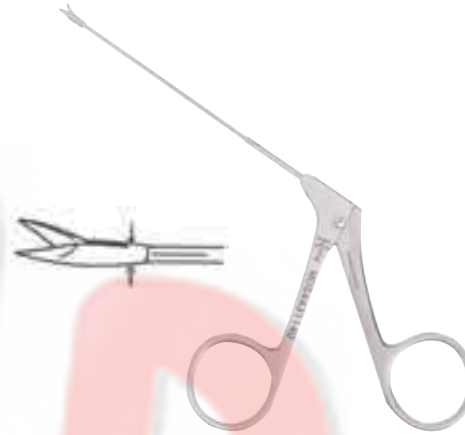

### HOUSE-BELLUCCI ALLIGATOR SCISSORS

Working length 3" (7.6cm), overall length 5<sup>1</sup>/<sub>4</sub>" (13.4cm).

<u>Item Number</u>	<u>Description</u>
MDS4431046	Extra-delicate tip
MDS4431040	Delicate tip



### HOUSE-DIETER MALLEUS NIPPER

2mm fine jaws.

<u>Item Number</u>	<u>Description</u>
MDS4438501	Working length 3" (7.6cm)



## HOUSE ALLIGATOR CRIMPER FORCEPS

Fine, serrated jaws, length 8mm.

<u>Item Number</u>	<u>Description</u>
MDS4499601	Working length 3" (7.6cm)



## MCGEE WIRE-CRIMPING FORCEPS

Fine 3mm jaws. Angled down.

<u>Item Number</u>	<u>Description</u>
MDS4437140	Working length 2 <sup>7</sup> / <sub>8</sub> " (7.2cm)

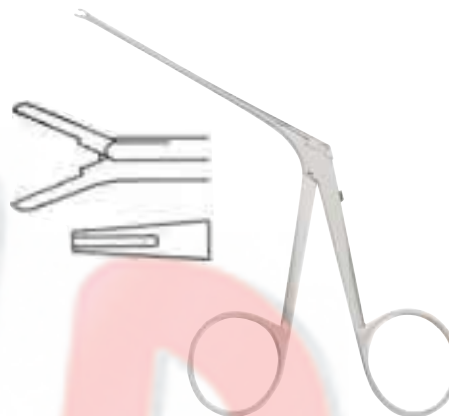

## JUERS CRIMPING FORCEPS

Fine 6mm jaws. Working length 3" (7.6cm).

<u>Item Number</u>	<u>Description</u>
MDS0394591	Jaws offset right
MDS0394596	Jaws offset left



## HOUSE WIRE GUIDE

.6mm long tip, notched at the end.

<u>Item Number</u>	<u>Description</u>
MDS4441001	Overall length 6 <sup>1</sup> / <sub>2</sub> " (16.5cm)



## ANDREWS-HARTMANN RONGEUR FORCEPS

Slightly curved.

<u>Item Number</u>	<u>Description</u>
MDS4627500	Overall length 5 <sup>5</sup> / <sub>8</sub> " (14.4cm)



## SHEARER CHICKEN-BILL RONGEUR FORCEPS

Small jaws.

<u>Item Number</u>	<u>Description</u>
MDS4627640	Overall length 5 <sup>3</sup> / <sub>4</sub> " (14.5cm)

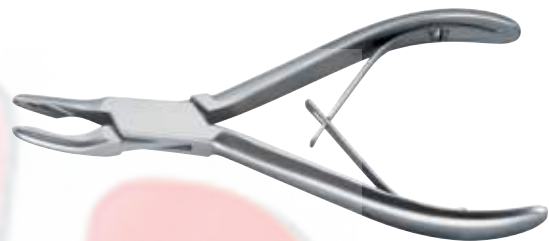

## KERRISON RONGEUR FORCEPS

Working length 3<sup>1</sup>/<sub>2</sub>" (9cm).

<u>Item Number</u>	<u>Description</u>
MDS4630313	Extra-small, size 0, jaws 3mm wide
MDS4630304	Small, size 1, jaws 4mm wide
MDS4630305	Medium, size 2, jaws 5mm wide
MDS4630306	Large, size 3, jaws 6mm wide



## LEMPERT RONGEUR FORCEPS

Light model with slender jaws.

<u>Item Number</u>	<u>Description</u>
MDS4630870	Jaws 7mm x 2.5mm wide, overall length 7 <sup>1</sup> / <sub>2</sub> " (19cm)
MDS4630872	Jaws 10mm x 2mm wide, overall length 6 <sup>1</sup> / <sub>2</sub> " (16.5cm)
MDS4630874	Jaws 10mm x 3mm wide, overall length 9" (22.9cm)



## JUERS-LEMPERT RONGEUR FORCEPS

Straight jaws on curved handles, 2.5mm wide.

<u>Item Number</u>	<u>Description</u>
MDS4641380	Overall length 7" (17.8cm)



## LEMPERT RONGEUR FORCEPS

Curved jaws, 3mm wide.

<u>Item Number</u>	<u>Description</u>
MDS4641385	Overall length 7½" (19.1cm)



## CICHERELLI RONGEUR FORCEPS

Curved.

<u>Item Number</u>	<u>Description</u>
MDS1803251	Overall length 6½" (16.5cm)



## BANE RONGEUR FORCEPS

Curved jaws taper to tip.

<u>Item Number</u>	<u>Description</u>
MDS9911050	Overall length 6⅞" (17.5cm)





### OLIVECRONA RONGEUR FORCEPS

Strongly curved jaws, 18mm x 4.5mm wide.

<u>Item Number</u>	<u>Description</u>
MDS4643561	Overall length 8" (20.3cm)



### LUER-WHITING RONGEUR FORCEPS

Curved jaws, 13mm x 6.5mm wide.

<u>Item Number</u>	<u>Description</u>
MDS3213717	Overall length 7" (18cm)



### RUSKIN RONGEUR FORCEPS

Double-action. Slightly curved jaws.  
Overall length 7 1/2" (19cm).

<u>Item Number</u>	<u>Description</u>
MDS3223655	Jaws 5mm wide
MDS3223656	Jaws 6mm wide



### BEYER RONGEUR FORCEPS

Double-action. Fine.

<u>Item Number</u>	<u>Description</u>
MDS3220018	Bite 15mm x 3mm wide, overall length 7" (18cm)
MDS3220118	Bite 15mm x 4mm wide, overall length 7" (18cm)



## RUSKIN MINI RONGEURS

Bite 15mm x 3mm wide. Overall length 6" (15.2cm).

<u>Item Number</u>	<u>Description</u>
--------------------	--------------------

MDS3221115	Straight
------------	----------

MDS3221715	Curved
------------	--------



## WILDE EAR FORCEPS

Angled, with serrated tips. Mirror finish.

<u>Item Number</u>	<u>Description</u>
--------------------	--------------------

MDS4420110	Regular size, overall length 4 <sup>3</sup> / <sub>8</sub> " (11.1cm)
------------	--

MDS4420114	Extra-long shanks, overall length 5 <sup>1</sup> / <sub>2</sub> " (14cm)
------------	---

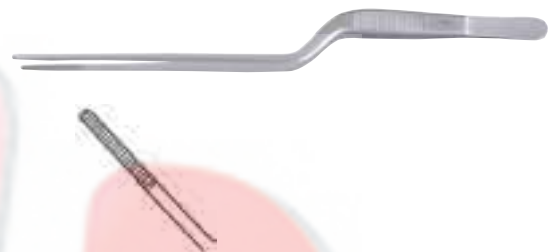

## BLAKE EAR FORCEPS

Small, light, fine. Angled, with serrated tips. Mirror finish.

<u>Item Number</u>	<u>Description</u>
--------------------	--------------------

MDS4426109	Overall length 3 <sup>1</sup> / <sub>2</sub> " (8.9cm)
------------	--

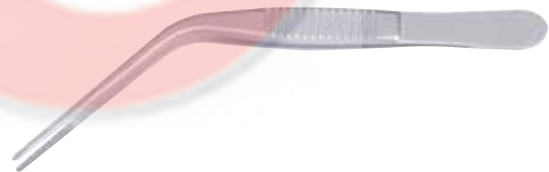

## LUCAE EAR FORCEPS

Bayonet-shaped. Serrated tips.

<u>Item Number</u>	<u>Description</u>
--------------------	--------------------

MDS4420614	Overall length 5 <sup>3</sup> / <sub>4</sub> " (14.6cm)
------------	---

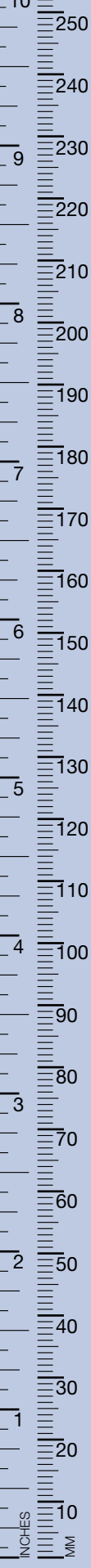

## GRUENWALD EAR FORCEPS

Bayonet-shaped. Serrated tips.

<u>Item Number</u>	<u>Description</u>
MDS4615720	Overall length 6 <sup>3</sup> / <sub>8</sub> " (16.2cm)



## SHEEHY OSSICLE HOLDING FORCEPS

4 x 5 teeth.

<u>Item Number</u>	<u>Description</u>
MDS0315436	Overall length 4 <sup>3</sup> / <sub>4</sub> " (12.1cm)



## HOUSE HANDHELD RETRACTOR

Double-ended. Blades 20mm x 7mm and 25mm x 9mm wide.

<u>Item Number</u>	<u>Description</u>
MDS0378111	Overall length 6" (15.2cm)



## ALLPORT MASTOID RETRACTOR

4 x 4 blunt prongs.

<u>Item Number</u>	<u>Description</u>
MDS1862117	Overall length 2 <sup>5</sup> / <sub>8</sub> " (6.8cm)



## JANSEN MASTOID RETRACTOR

3 x 3 blunt prongs.

<u>Item Number</u>	<u>Description</u>
MDS1862910	Overall length 4" (10cm)



## GIFFORD MASTOID RETRACTOR

3 x 3 blunt prongs.

<u>Item Number</u>	<u>Description</u>
MDS1832016	Overall length 3" (7.6cm)



## SNITMAN ENDAURAL RETRACTOR

3 x 3 sharp prongs. Jaw opening 2" (5.1cm).

<u>Item Number</u>	<u>Description</u>
MDS1862710	Overall length 4 <sup>3</sup> / <sub>16</sub> " (10.6cm)

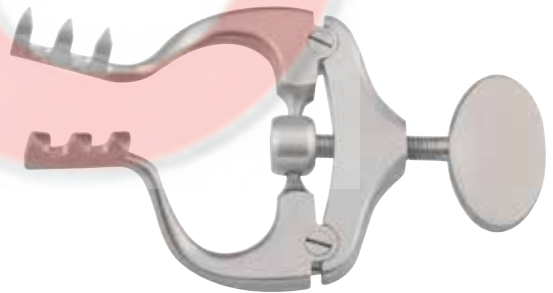

## WULLSTEIN RETRACTORS

3 x 3 sharp prongs. Angled shanks.

<u>Item Number</u>	<u>Description</u>
MDS1866210	Arm length 2 <sup>1</sup> / <sub>2</sub> " (6.4cm), overall length 4 <sup>1</sup> / <sub>8</sub> " (10.5cm)
MDS1866213	Arm length 3 <sup>1</sup> / <sub>8</sub> " (8cm), overall length 5" (12.7cm)



## SCHUKNECHT SELF-RETAINING POSTAURICULAR RETRACTOR

3 x 3 sharp prongs. Angled shanks.  
Arm length 3" (7.6cm).

<u>Item Number</u>	<u>Description</u>
MDS1868814	Overall length 5 1/2" (14cm)



## PERKINS OTOLOGIC RETRACTORS

Rake blade is 1/2" x 3/4" (1.3cm x 1.9cm); solid blade, curved and serrated, is 1/2" x 1" (1.3cm x 2.5cm).  
Total opening 2 1/4" (5.7cm). Overall length 5 1/4" (13.3cm).

<u>Item Number</u>	<u>Description</u>
MDS0388160	Left for patient's left
MDS0388168	Right for patient's right



## PAPARELLA RETRACTOR

Angled 2 x 2 sharp prongs.

<u>Item Number</u>	<u>Description</u>
MDS0388131	Overall length 5" (12.7cm)

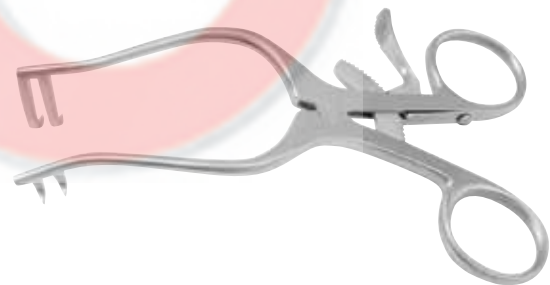

## WIET OTOLOGIC SCISSORS

Bayonet-shaped. Castoviejo-style.

<u>Item Number</u>	<u>Description</u>
MDS4431045	Straight blades, overall length 6 1/2" (16.5cm)



## MCCABE FACIAL NERVE DISSECTOR

For parotid surgery. Angled, smooth jaws, length 14mm.

<u>Item Number</u>	<u>Description</u>
MDS0302590	Overall length 5½" (14cm)



## HOUSE PRESSURE FORCEPS

1.6cm x 1.2cm wide jaw.

<u>Item Number</u>	<u>Description</u>
MDS0303236	Overall length 7½" (19cm)



## HARTMANN TUNING FORKS

Class C. Magnesium-aluminum alloy.

<u>Item Number</u>	<u>Description</u>
MDS4406007	C64HZ
MDS4407203	C128HZ
MDS4407202	C256HZ
MDS4407003	C512HZ
MDS4407004	C1024HZ
MDS4407005	C2048HZ
MDS4407201	C4096HZ
MDS4407100	Standard set of five tuning forks in durable, compact case, includes one each of forks C128HZ, C256HZ, C512HZ, C1024HZ and C2048HZ



# Nasal





## VIENNA NASAL SPECULA

Standard pattern.

<u>Item Number</u>	<u>Description</u>
MDS4611201	Small, blade 9.4mm x 27mm
MDS4611202	Medium, blade 11.2mm x 30mm
MDS4611203	Large, blade 12.7mm x 32mm



## MERZ-VIENNA NASAL SPECULA

Light, with fine spring. Thin blades, rounded at proximal portion. Overall length  $5\frac{3}{8}$ " (13.6cm).

<u>Item Number</u>	<u>Description</u>
MDS4611301	Small, blade 27mm x 4.8mm
MDS4611302	Medium, blade 25mm x 6.3mm
MDS4611303	Large, blade 32mm x 6.5mm



## LILLIE NASAL SPECULUM

Thin, round blades for maximum field. Blade 32mm x 3.6mm wide.

<u>Item Number</u>	<u>Description</u>
MDS4611420	Overall length 5" (13cm)

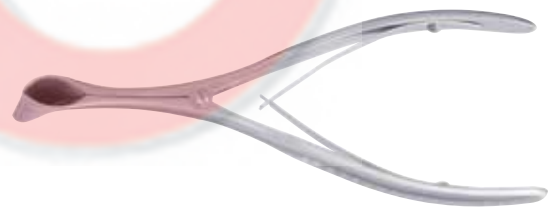

## SONNENSCHN NASAL SPECULA

Medium. Blade 29mm wide.

<u>Item Number</u>	<u>Description</u>
MDS4611540	Overall length $6\frac{1}{8}$ " (15.5cm)



## KILLIAN NASAL SPECULA

With set screw. Overall length 5" (12.5cm).

<u>Item Number</u>	<u>Description</u>
MDS4612050	Small blade 51mm
MDS4612065	Medium blade 64mm
MDS4612075	Large blade 76mm
MDS4612090	Extra-large blade 90mm



## BECKMAN-COLVER NASAL SPECULUM

Blade 29mm.

<u>Item Number</u>	<u>Description</u>
MDS4607003	Overall length 5 <sup>3</sup> / <sub>4</sub> " (14.6cm)

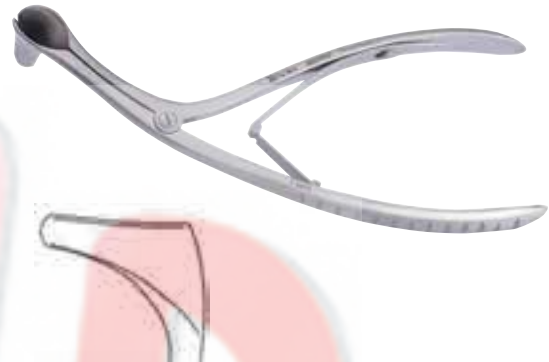

## HALLE-TIECK NASAL SPECULA

Very small size. Blade 18mm.

<u>Item Number</u>	<u>Description</u>
MDS4611613	Overall length 5 <sup>1</sup> / <sub>4</sub> " (13.5cm)

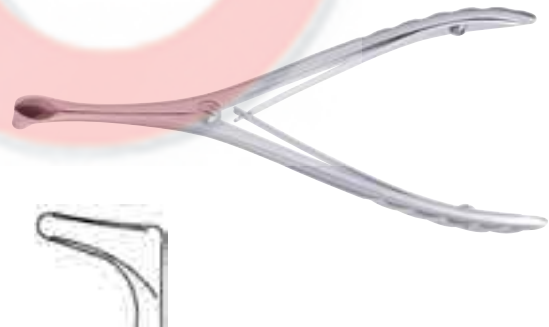

## COTTLE NASAL SPECULA

A modified Killian speculum with narrowed, tapering blades 5cm long. With set screw.

<u>Item Number</u>	<u>Description</u>
MDS4612650	Overall length 5 <sup>3</sup> / <sub>4</sub> " (14.6cm)



## COTTLE SPECULA

Overall length 5 $\frac{3}{8}$ " (13.6cm).

<u>Item Number</u>	<u>Description</u>
MDS4612530	Short 30mm blades taper from 4mm to 9mm wide
MDS4612535	Short 35mm blades taper from 8mm to 10mm wide
MDS4612550	Medium 50mm blades taper from 8mm to 10mm wide
MDS4612555	Medium 55mm blades taper from 8mm to 10mm wide
MDS4612560	Medium 60mm narrow blades taper from 5mm to 9mm wide
MDS4612570	Medium-long 70mm blades taper from 8mm to 10mm wide
MDS4612575	Long 75mm blades taper from 8mm to 10mm wide
MDS4612580	Long 80mm blades taper from 8mm to 10mm wide
MDS4612590	Extra-long 90mm blades taper from 8mm to 10mm wide



## SINGLE PRONG MICRO HOOKS

Overall length 6 $\frac{1}{4}$ " (15.9cm).

<u>Item Number</u>	<u>Description</u>
MDS1820602	Small, sharp tip, 1mm
MDS1820601	Large, sharp tip, 2mm



## DOUBLE PRONG MICRO HOOKS

Overall length 6 $\frac{1}{4}$ " (15.9cm).

<u>Item Number</u>	<u>Description</u>
MDS1824602	Sharp, 2mm between tips
MDS1824605	Sharp, 5mm between tips
MDS1824607	Sharp, 7mm between tips
MDS1824610	Sharp, 10mm between tips
MDS1823602	Blunt, 2mm between tips
MDS1823605	Blunt, 5mm between tips
MDS1823607	Blunt, 7mm between tips
MDS1823610	Blunt, 10mm between tips



## NASAL TENACULA JOSEPH HOOKS

Overall length 6¼" (15.9cm)

Item Number	Description
MDS1821601	Single sharp hook, 5.8mm diameter
MDS1821602	Double hook, 2mm between sharp prongs
MDS1821605	Double hook, 5mm between sharp prongs
MDS1821607	Double hook, 7mm between sharp prongs
MDS1821610	Double hook, 10mm between sharp prongs

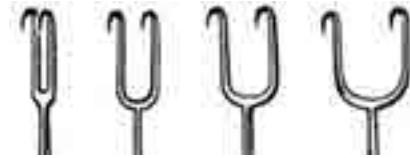

## CONVERSE SKIN HOOKS

Overall length 7" (17.8cm).

Item Number	Description
MDS1822201	No. 1, hook diameter 1.8mm
MDS1822202	No. 2, hook diameter 2.5mm
MDS1822203	No. 3, hook diameter 3.4mm



## KLEINERT-KUTZ SKIN HOOKS

Overall length 6¾" (16.2cm).

Item Number	Description
MDS1821301	No. 1, hook diameter 2.5mm
MDS1821302	No. 2, hook diameter 4.2mm
MDS1821303	No. 3, hook diameter 4.8mm

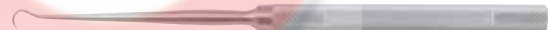

## COTTLE SHARP TENACULUM

Item Number	Description
MDS0268311	Small shallow curve, overall length 5⅞" (13.6cm)
MDS0268321	Small deep curve, overall length 5⅞" (13.6cm)
MDS1841714	Large deep curve, overall length 5⅞" (13.6cm)



## COTTLE DOUBLE HOOK

3mm between prongs.

<u>Item Number</u>	<u>Description</u>
MDS1831603	Overall length 6" (15.2cm)



## STRAIGHT'S SINGLE TENACULUM

Sharp.

<u>Item Number</u>	<u>Description</u>
MDS1831413	Overall length 5 <sup>3</sup> / <sub>8</sub> " (13.6cm)



## GILLIES SKIN HOOKS

Overall length 7" (17.8cm).

<u>Item Number</u>	<u>Description</u>
MDS4656018	Small, hook diameter 3mm
MDS4656218	Large, hook diameter 4mm



## COTTLE RETRACTORS

11mm between two prongs. Overall length 6" (15.2cm).

<u>Item Number</u>	<u>Description</u>
MDS4655614	Sharp prongs



## COTTLE-NEIVERT RETRACTOR

Double-ended. Blades 12mm and 7mm wide. 9mm between blunt prongs, other end with rounded edges.

<u>Item Number</u>	<u>Description</u>
MDS4655920	Overall length 8 <sup>5</sup> / <sub>8</sub> " (21.9cm)



## PECK RAKE RETRACTOR

Four sharp prongs. Jaw tip 8mm wide.

<u>Item Number</u>	<u>Description</u>
MDS4237913	Overall length 5 <sup>3</sup> / <sub>8</sub> " (13.6cm)



## FOMON NOSTRIL ELEVATOR-RETRACTOR

13mm between ball-tipped prongs.

<u>Item Number</u>	<u>Description</u>
MDS4655616	Overall length 6 <sup>1</sup> / <sub>4</sub> " (15.9cm)



## NEIVERT RETRACTOR

Double-ended. Blades 12mm and 3.8mm wide. 11mm between ball-tipped prongs.

<u>Item Number</u>	<u>Description</u>
MDS4655921	Overall length 8 <sup>1</sup> / <sub>2</sub> " (21.8cm)



## COTTLE FOUR PRONG RETRACTOR

Blunt prongs, 2mm wide.

<u>Item Number</u>	<u>Description</u>
MDS4689914	Overall length 6½" (16.5cm)



## CONVERSE ALAR RETRACTOR

Double-ended, 12mm and 14mm wide ends.

<u>Item Number</u>	<u>Description</u>
MDS4690312	Overall length 4½" (11.4cm)



## CONVERSE BLADE RETRACTOR

Overall length 3¾" (9.5cm)

<u>Item Number</u>	<u>Description</u>
MDS4667701	Size 1, 18mm x 9mm
MDS4667702	Size 2, 21mm x 12mm
MDS4667703	Size 3, 38mm x 12mm
MDS4667704	Size 4, 53mm x 12mm



## LUER "S" RETRACTOR

Double-ended, 6mm and 15mm wide ends.

<u>Item Number</u>	<u>Description</u>
MDS1895514	Overall length 5½" (14cm)





## CONVERSE NASAL RETRACTOR

Blade 44mm x 11mm wide.

<u>Item Number</u>	<u>Description</u>
MDS1690812	Overall length 4½" (11.4cm)



## DINGMAN FLEXSTEEL RETRACTOR

Malleable.

<u>Item Number</u>	<u>Description</u>
MDS1813841	7" x ½" (17.8cm x 1.3cm) wide



## AUFRICHT RETRACTOR-SPECULUM

Blade 50mm x 13mm wide.

<u>Item Number</u>	<u>Description</u>
MDS4655116	Overall length 7½" (18.9cm)



## DAVIS RETRACTOR

Double-ended, with slightly lipped blades for support.  
Blades 19mm x 9mm wide and 23mm x 6.4mm wide.

<u>Item Number</u>	<u>Description</u>
MDS1816415	Overall length 6" (15.2cm)



## JOSEPH SCISSORS

Sharp/sharp. Blades 3.5cm from mid-screw.  
Overall length 5" (14cm).

Item Number	Description
MDS0830414	Straight
MDS0730414	Straight, serrated edges
MDS0830514	Curved
MDS0730514	Curved, serrated edges



## MICROSURGERY SCISSORS

Round handle. Overall length 6" (15.2cm).

Item Number	Description
MDS0940125	Straight blades, 13mm from screw
MDS0940115	Curved blades, 12mm from screw

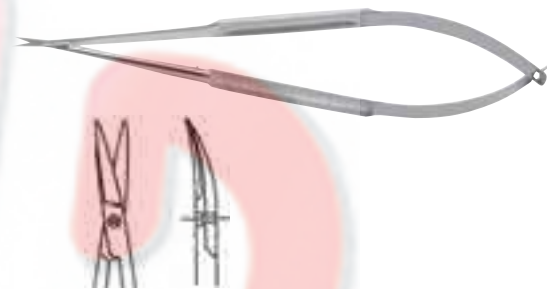

## METZENBAUM-LIPSETT SCISSORS

Curved. Serrated edges. Metzenbaum blades thinned down  $\frac{7}{8}$ " (2.2cm) from tips.

Item Number	Description
MDS0825861	Overall length 5 $\frac{1}{2}$ " (14cm)



## FOMON SABER-BACK SCISSORS

Serrated, curved blades.

Item Number	Description
MDS0841514	Overall length 5" (12.7cm)



## FOMON UPPER LATERAL SCISSORS

Fully curved blades.

<u>Item Number</u>	<u>Description</u>
MDS0840713	Overall length 5 <sup>1</sup> / <sub>4</sub> " (13.5cm)



## FOMON ANGULAR SCISSORS

Light pattern, with ground-out blades.

<u>Item Number</u>	<u>Description</u>
MDS0840315	Overall length 5 <sup>3</sup> / <sub>4</sub> " (14.6cm)

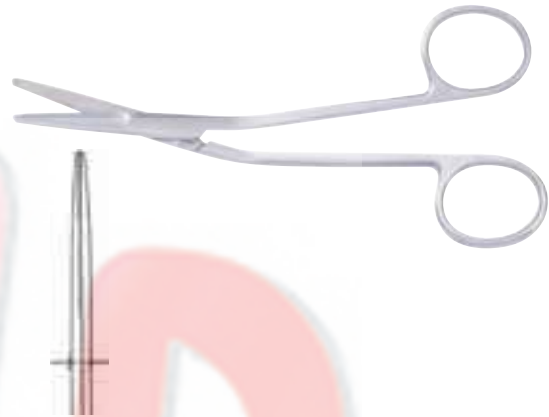

## MAYO MICRO DISSECTING SCISSORS

Curved-on-flat. Blunt/blunt.

<u>Item Number</u>	<u>Description</u>
MDS0816114	Overall length 5 <sup>1</sup> / <sub>2</sub> " (14cm)

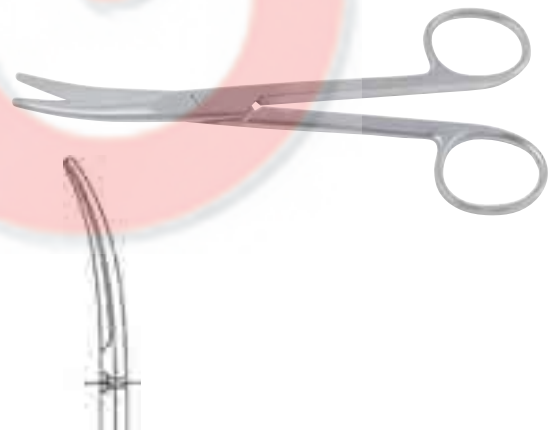

## SUPER CUT METZENBAUM DISSECTING SCISSORS

Mirror finish. Overall length 5<sup>3</sup>/<sub>4</sub>" (14.6cm).

<u>Item Number</u>	<u>Description</u>
MDS0728115	Overall length 5 <sup>3</sup> / <sub>4</sub> " (14.6cm)



## RAGNELL NASAL SCISSORS

Curved.

<u>Item Number</u>	<u>Description</u>
MDS0830912	Overall length 5 1/4" (13.3cm)



## CAPLAN ANGULAR SCISSORS

Double-action, angled-on-flat, serrated blades.

<u>Item Number</u>	<u>Description</u>
MDS0870722	Overall length 7 1/2" (19cm)



## COTTLE ANGULAR SCISSORS

Heavy, rounded blades. Mirror finish.

<u>Item Number</u>	<u>Description</u>
MDS0870616	Overall length 6 1/2" (16.5cm)



## COTTLE HEAVY SEPTUM SCISSORS

With serrated blade. Angled.

<u>Item Number</u>	<u>Description</u>
MDS0870817	Overall length 6 7/8" (17.5cm)



## LITTLER SUTURE-CARRYING SCISSORS

8mm from tips. Mirror finish.

<u>Item Number</u>	<u>Description</u>
MDS0809711	Overall length 4½" (12cm)
MDS0809714	Overall length 5½" (14cm)



## COTTLE BULLDOG SCISSORS

Blunt blades, slightly curved-on-flat.

<u>Item Number</u>	<u>Description</u>
MDS0802771	Overall length 4½" (11.5cm)



## KNIGHT NASAL SCISSORS

Angled-on-side.

<u>Item Number</u>	<u>Description</u>
MDS0840918	Overall length 6¾" (17.2cm)

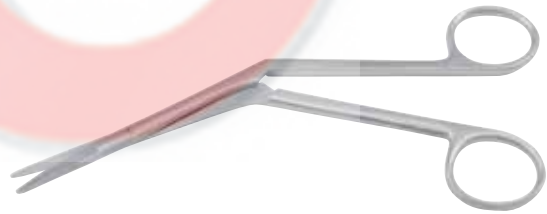

## SUPER CUT PLASTIC & RECONSTRUCTIVE SCISSORS

Curved. One serrated blade.

<u>Item Number</u>	<u>Description</u>
MDS0728111	Overall length 4½" (11.4cm)
MDS0728114	Overall length 5½" (14cm)



## SUPER CUT GORNEY PLASTIC SURGERY SCISSORS

Beveled blades. Blunt/blunt. One serrated blade.  
Overall length 7½" (19cm).

<u>Item Number</u>	<u>Description</u>
MDS0728219	Curved



## SUPER CUT FREEMAN-KAYE SCISSORS

Beveled blades with flat tips. Blunt/blunt.  
One serrated blade. Overall length 7" (17.8cm).

<u>Item Number</u>	<u>Description</u>
MDS0728418	Curved



## FREEMAN RHYTIDECTOMY SCISSORS

<u>Item Number</u>	<u>Description</u>
MDS0728618	Overall length 7" (17.8cm)

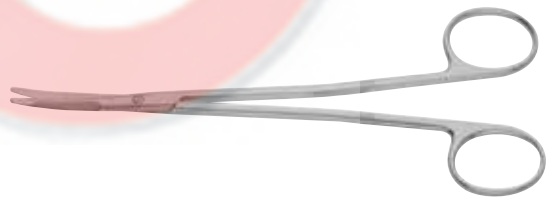

## WEBSTER NEEDLE HOLDERS

Light, with smooth jaws. Overall length 5" (12.7cm).

<u>Item Number</u>	<u>Description</u>
MDS2410013	Mirror finish



## CONVERSE NEEDLE HOLDER

Light, with longitudinally-serrated jaws. Small.

<u>Item Number</u>	<u>Description</u>
MDS2412012	Overall length 4 <sup>3</sup> / <sub>8</sub> " (11cm)



## NEIVERT NEEDLE HOLDER

For nasal suturing. Offset ring.

<u>Item Number</u>	<u>Description</u>
MDS2414613	Overall length 5" (12.7cm)



## GRUENWALD EAR FORCEPS

Bayonet-shaped. Serrated tips.

<u>Item Number</u>	<u>Description</u>
MDS4615720	Overall length 6 <sup>3</sup> / <sub>8</sub> " (16.2cm)



## CUSHING TISSUE AND DRESSING FORCEPS

Bayonet. Serrated, square dissecting tip.

<u>Item Number</u>	<u>Description</u>
MDS1235019	Overall length 7 <sup>5</sup> / <sub>8</sub> " (19.4cm)
MDS1235119	1 x 2 teeth, overall length 7 <sup>5</sup> / <sub>8</sub> " (19.4cm)





## GRUENWALD TISSUE FORCEPS

Bayonet. 1 x 2 teeth.

<u>Item Number</u>	<u>Description</u>
MDS4420430	Overall length 6 $\frac{1}{4}$ " (15.9cm)



## FISH NASAL GRASPING AND DRESSING FORCEPS

Alligator-type. Serrated jaws. Jaw length 12mm.

<u>Item Number</u>	<u>Description</u>
MDS4642103	Overall length 7" (17.8cm)



## CALLISON-ADSON TISSUE/TYING FORCEPS

1 x 2 teeth, tying platform.

<u>Item Number</u>	<u>Description</u>
MDS4622195	Overall length 5" (12.7cm)



## BEASLEY-BABCOCK TISSUE FORCEPS

<u>Item Number</u>	<u>Description</u>
MDS0141766	Overall length 5" (12.7cm)



## WATSON-WILLIAMS POLYP FORCEPS

Working length  $4\frac{3}{8}$ " (11cm).

<u>Item Number</u>	<u>Description</u>
MDS4619603	Small, jaw length 6.5mm
MDS4619604	Large, jaw length 10mm



## MACKENTY SEPTUM ELEVATOR

Flat, curved blade, Overall length  $5\frac{3}{4}$ " (14.6cm).

<u>Item Number</u>	<u>Description</u>
MDS4641004	4.3mm wide
MDS4641005	5mm wide

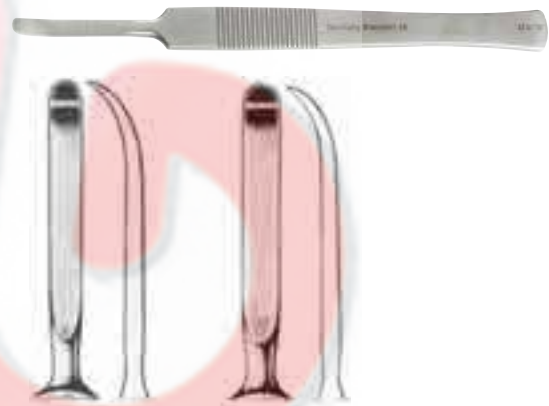

## CUSHING "LITTLE JOKER" ELEVATOR

Small. Blunt blade, 6mm wide.

<u>Item Number</u>	<u>Description</u>
MDS3276119	Overall length $7\frac{1}{4}$ " (18.4cm)



## LOVE-ADSON PERIOSTEAL ELEVATOR

Semi-sharp blade, 5mm wide.

<u>Item Number</u>	<u>Description</u>
MDS3275817	Overall length $6\frac{1}{2}$ " (16.5cm)



## FREER SEPTUM ELEVATOR

Double-ended, sharp and blunt.

<u>Item Number</u>	<u>Description</u>
MDS4641518	Overall length 7 <sup>3</sup> / <sub>4</sub> " (19.7cm)



## HAMRICK SUCTION DISSECTOR AND ELEVATOR

Blunt elevator blade with suction connector and obturator. Tubular, blunt end and fitting to connect with suction apparatus.

<u>Item Number</u>	<u>Description</u>
MDS4641717	Overall length 6 <sup>3</sup> / <sub>4</sub> " (17.2cm)



## COTTLE ELEVATOR-FEELER

Double-ended. Graduated in centimeters. Blades 47mm.

<u>Item Number</u>	<u>Description</u>
MDS4642322	Overall length 9" (22.9cm)



## DINGMAN PERIOSTEAL ELEVATOR

Double-ended.

<u>Item Number</u>	<u>Description</u>
MDS4642518	Overall length 7" (17.8cm)



## COTTLE-MACKENTY ELEVATOR

Double-ended. Curved blades, 5mm wide.

<u>Item Number</u>	<u>Description</u>
MDS4641122	Overall length 8½" (22cm)



## COTTLE ELEVATOR

Double-ended. Blades 3.2mm.

<u>Item Number</u>	<u>Description</u>
MDS4642123	Overall length 8⅞" (22.5cm)

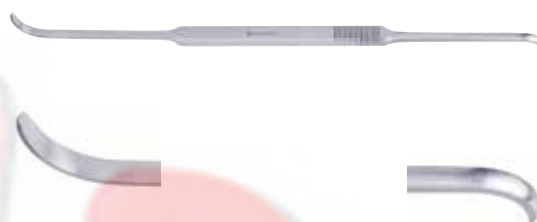

## PIERCE SUBMUCOUS DISSECTOR

Double-ended with right and left blades. Spherical style.

<u>Item Number</u>	<u>Description</u>
MDS4653721	Overall length 7½" (19.1cm)

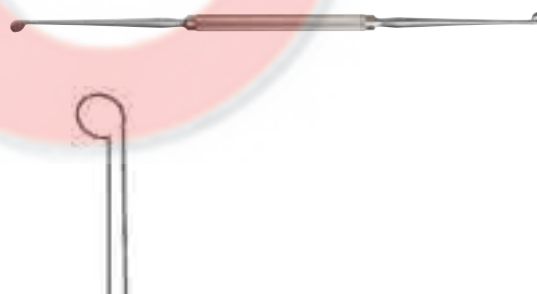

## GOLDMAN DISPLACER AND SEPTUM ELEVATOR

Tip 6mm wide.

<u>Item Number</u>	<u>Description</u>
MDS4630620	Overall length 7½" (19cm)



## JOSEPH PERIOSTEOTOMES

Blade 5mm wide. Overall length 6½" (16.5cm).

<u>Item Number</u>	<u>Description</u>
MDS4642516	Slightly curved blade



## CUSHING ELEVATOR

Narrow. Sharp blade, 8mm wide.

<u>Item Number</u>	<u>Description</u>
MDS3276220	Overall length 7¾" (19.7cm)



## HAJEK-BALLENGER SEPTUM ELEVATOR AND DISSECTOR

Double-ended. Sharp and blunt blades.

<u>Item Number</u>	<u>Description</u>
MDS4642821	Overall length 7½" (19.1cm)



## DINGMAN ZYGOMA ELEVATOR

Heavy, with curved, rounded blade.

<u>Item Number</u>	<u>Description</u>
MDS4643000	Overall length 8⅝" (21.3cm)



## BOIES NASAL FRACTURE ELEVATOR

Tip 9mm.

<u>Item Number</u>	<u>Description</u>
MDS4630418	Overall length 7½" (19.1cm)



## PENNINGTON SEPTUM ELEVATOR AND DISSECTOR

Double-ended.

<u>Item Number</u>	<u>Description</u>
MDS4653921	Overall length 8¼" (21cm)



## COTTLE NASAL KNIFE

Stiff blade with 5.5mm rounded edge.

<u>Item Number</u>	<u>Description</u>
MDS4638215	Overall length 5⅝" (14.3cm)



## JOSEPH BUTTON-END KNIFE

Straight with probe point. 32mm x 4.2mm wide.

<u>Item Number</u>	<u>Description</u>
MDS4637616	Overall length 5½" (14cm)

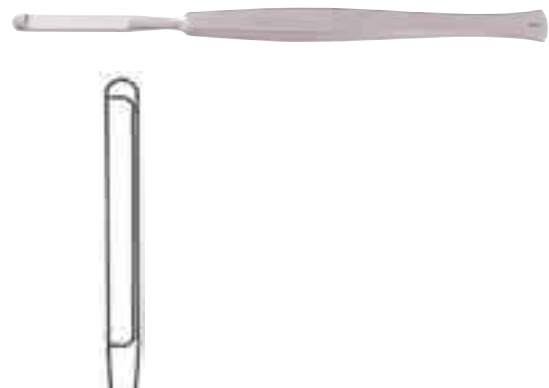

## BALLENGER SWIVEL KNIVES

Straight. Overall length 7<sup>3</sup>/<sub>4</sub>" (19.7cm).

<u>Item Number</u>	<u>Description</u>
MDS4639003	Blade 3mm wide
MDS4639004	Blade 4mm wide
MDS4639005	Blade 5mm wide
MDS4639203	Bayonet style, blade 3mm wide
MDS4639204	Bayonet style, blade 4mm wide
MDS4639205	Bayonet style, blade 5mm wide

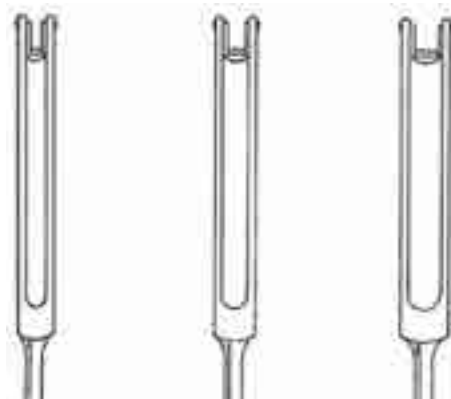

## CINELLI OSTEOTOMES

Double guards. Overall length 6<sup>1</sup>/<sub>2</sub>" (16.5cm).

<u>Item Number</u>	<u>Description</u>
MDS4647210	Straight, blade 10mm wide
MDS4647212	Straight, blade 12mm wide
MDS4647214	Straight, blade 14mm wide
MDS4647216	Straight, blade 16mm wide
MDS4647218	Curved, blade 10mm wide



## RUBIN OSTEOTOMES

Overall length 6<sup>1</sup>/<sub>2</sub>" (16.5cm).

<u>Item Number</u>	<u>Description</u>
MDS4646810	Blade 10mm wide
MDS4646814	Blade 14mm wide



## FREER SEPTUM KNIFE

Blade length 5mm.

<u>Item Number</u>	<u>Description</u>
MDS4637415	Overall length 6 <sup>1</sup> / <sub>4</sub> " (15.9cm)





## CONVERSE OSTEOTOMES

Straight. Overall length 7" (17.8cm).

<u>Item Number</u>	<u>Description</u>
MDS3268702	2mm wide
MDS3268704	4mm wide
MDS3268706	6mm wide
MDS3268708	8mm wide
MDS3268710	10mm wide
MDS3268712	12mm wide



## SILVER OSTEOTOMES

Guarded. Cutting edge  $\frac{3}{16}$ " (5mm).  
Overall length  $6\frac{7}{8}$ " (17.5cm).

<u>Item Number</u>	<u>Description</u>
MDS4647301	Straight
MDS4647302	Curved left
MDS4647303	Curved right



## ANDERSON-NEIVERT OSTEOTOMES

Guarded. Blade 6mm wide. Overall length 8" (20.3cm).

<u>Item Number</u>	<u>Description</u>
MDS4647901	Curved left
MDS4647902	Curved right



## PARKES OSTEOTOME

Guarded. Straight. Blade 5mm wide.

<u>Item Number</u>	<u>Description</u>
MDS4646215	Overall length $6\frac{1}{4}$ " (15.9cm)



## NEIVERT OSTEOTOME

Guarded. Straight. Cutting edge 5mm.

<u>Item Number</u>	<u>Description</u>
MDS4647820	Overall length 8" (20.3cm)



## FREER SUBMUCOUS CHISELS

Tip 5mm wide. Working length 7 1/2" (19cm).

<u>Item Number</u>	<u>Description</u>
MDS4645004	Straight tip
MDS4645104	Curved tip



## HAJEK SEPTUM CHISELS

V-shaped cutting edge. Overall length 6" (15.2cm).

<u>Item Number</u>	<u>Description</u>
MDS4648404	No. 1, small, 4mm
MDS4648406	No. 2, medium, 6mm
MDS4648408	No. 3, large, 8mm



## FOMON CHISEL

Guarded. One size, 7mm blade.

<u>Item Number</u>	<u>Description</u>
MDS4647007	Overall length 6 1/4" (15.9cm)



## COTTLE CHISEL-OSTEOTOMES

Thin blade with depth markings.  
Overall length 7¼" (18.4cm).

<u>Item Number</u>	<u>Description</u>
MDS4645404	Blade 4mm wide
MDS4645407	Blade 7mm wide
MDS4645409	Blade 9mm wide
MDS4645412	Blade 12mm wide



## COTTLE CHISEL

Curved, with depth markings. Blade 6mm wide.

<u>Item Number</u>	<u>Description</u>
MDS4645506	Overall length 7¼" (18.4cm)

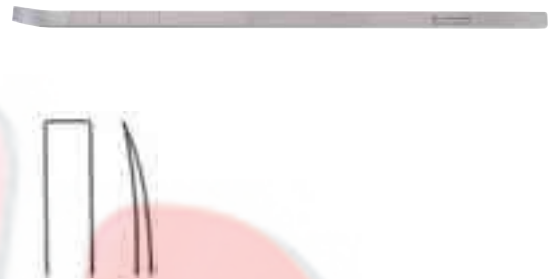

## CONVERSE CHISELS

Guarded. Blade 7.4mm wide.  
Overall length 7½" (19.1cm).

<u>Item Number</u>	<u>Description</u>
MDS4650001	Curved right
MDS4650002	Curved left

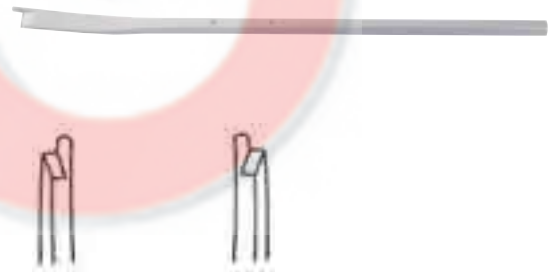

## GRUENWALD-BRYANT NASAL CUTTING FORCEPS

Working length 47/8" (12.4cm).

<u>Item Number</u>	<u>Description</u>
MDS4634701	Jaws 9mm x 2.5mm wide
MDS4634702	Jaws 10mm x 2.5mm wide
MDS4634703	Jaws 10mm x 3.5mm wide



## BLAKESLEY NASAL FORCEPS

Fenestrated jaws. Overall length 7<sup>1</sup>/<sub>8</sub>" (18cm).

<u>Item Number</u>	<u>Description</u>
MDS4622101	No. 0, cup 8mm x 3.5mm wide
MDS4622102	No. 1, cup 11mm x 4mm wide
MDS4622103	No. 2, cup 12mm x 5mm wide



## HAJEK-KOFFLER SPHENOID PUNCH FORCEPS

Reversible model. Up-cutting jaws.  
Bite size, 4mm x 3mm.

<u>Item Number</u>	<u>Description</u>
MDS4630816	Working length 7 <sup>1</sup> / <sub>8</sub> " (18cm)



## LILLIE-KILLIAN SEPTUM BONE FORCEPS

Reinforced serrated jaws.

<u>Item Number</u>	<u>Description</u>
MDS4617017	Overall length 6 <sup>3</sup> / <sub>4</sub> " (17.2cm)

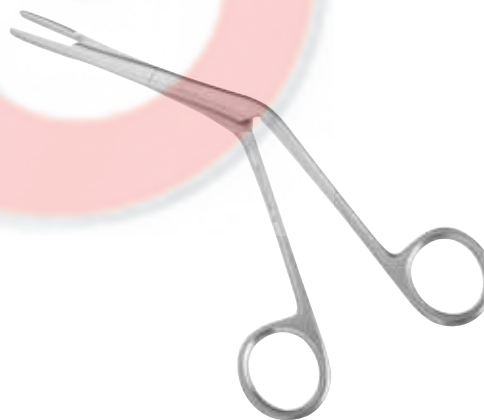

## FERRIS SMITH FRAGMENT FORCEPS

Alligator-type. Fenestrated, serrated jaws,  
8.2mm x 6.1mm.

<u>Item Number</u>	<u>Description</u>
MDS4631820	Working length 7 <sup>3</sup> / <sub>4</sub> " (19.7cm)



## JANSEN-MIDDLETON SEPTUM FORCEPS

Double-action. Spoon-shaped blades.

<u>Item Number</u>	<u>Description</u>
MDS4632517	Overall length 7 <sup>1</sup> / <sub>4</sub> " (18.4cm)

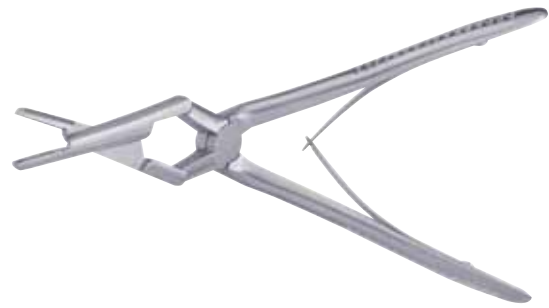

## JANSEN-STRUYCKEN SEPTUM FORCEPS

Double-action. Through-cutting blades.

<u>Item Number</u>	<u>Description</u>
MDS4632519	Overall length 7 <sup>3</sup> / <sub>4</sub> " (19.7cm)



## RUSKIN RONGEUR FORCEPS

Double-action. Slightly curved jaws.  
Overall length 7<sup>1</sup>/<sub>2</sub>" (19cm).

<u>Item Number</u>	<u>Description</u>
MDS3223655	Jaws 5mm wide
MDS3223656	Jaws 6mm wide



## LEMPERT RONGEUR FORCEPS

Light model with slender jaws.

<u>Item Number</u>	<u>Description</u>
MDS4630870	Jaws 7mm x 2.5mm wide, overall length 7 <sup>1</sup> / <sub>2</sub> " (19cm)
MDS4630872	Jaws 10mm x 2mm wide, overall length 6 <sup>1</sup> / <sub>2</sub> " (16.5cm)
MDS4630874	Jaws 10mm x 3mm wide, overall length 9" (22.9cm)



## SHEARER CHICKEN-BILL RONGEUR FORCEPS

Small jaws.

<u>Item Number</u>	<u>Description</u>
MDS4627640	Overall length 5 <sup>3</sup> / <sub>4</sub> " (14.5cm)



## COTTLE MALLETS

One flat face of replaceable nylon, one round face.  
Face 1<sup>1</sup>/<sub>8</sub>" (2.9cm) diameter.

<u>Item Number</u>	<u>Description</u>
MDS3277218	Overall length 8" (20.3cm)
MDS9901541	Nylon face replacement for MDS3277218



## LUCAE BONE MALLET

Face 1<sup>1</sup>/<sub>8</sub>" (2.8cm) diameter. Weight 11oz (311.3g).

<u>Item Number</u>	<u>Description</u>
MDS3269626	Overall length 8" (20.3cm)



## CRANE MALLET

Short handle. Face 1<sup>3</sup>/<sub>16</sub>" (3cm) diameter.  
Weight 8 oz (227g).

<u>Item Number</u>	<u>Description</u>
MDS3277020	Overall length 6 <sup>1</sup> / <sub>4</sub> " (15.9cm)



## COTTLE MALLET

One flat face for use with chisels, one round face for use with Cottle Bone Crusher. Face 1 $\frac{1}{8}$ " (2.9cm) diameter.

<u>Item Number</u>	<u>Description</u>
MDS3274624	Overall length 8" (20.3cm)



## COTTLE BONE CRUSHER

For preparation of cartilage implant material.

<u>Item Number</u>	<u>Description</u>
MDS4625800	Working area $\frac{5}{8}$ " x $2\frac{3}{4}$ " (1.6cm x 7cm)



## WALSHAM SEPTUM STRAIGHTENERS

Overall length 9" (22.9cm).

<u>Item Number</u>	<u>Description</u>
MDS4657224	Universal



## ASCH SEPTUM STRAIGHTENER

Angled.

<u>Item Number</u>	<u>Description</u>
MDS4657123	Overall length 8 $\frac{3}{4}$ " (22.2cm)





## RUBIN MORSELIZER

Jaws 17mm x 5mm wide.

<u>Item Number</u>	<u>Description</u>
MDS4625121	Overall length 8" (20.3cm)



## JOSEPH NASAL SAWS

Bayonet-type. Blade length 1 1/2" (3.8cm) long.  
Overall length 7 1/4" (18.4cm).

<u>Item Number</u>	<u>Description</u>
MDS4653219	Bent to left when teeth are up, for patient's right
MDS4653419	Bent to right when teeth are up, for patient's left

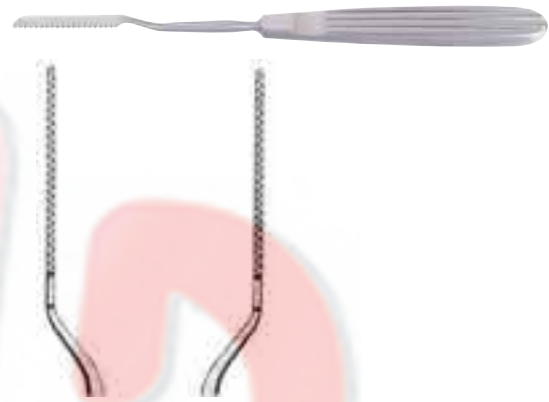

## AUFRICHT NASAL RASPS

Curved. Blade 25mm x 9mm wide.  
Overall length 8" (20.3cm).

<u>Item Number</u>	<u>Description</u>
MDS4650501	Up-cutting
MDS4650502	Down-cutting

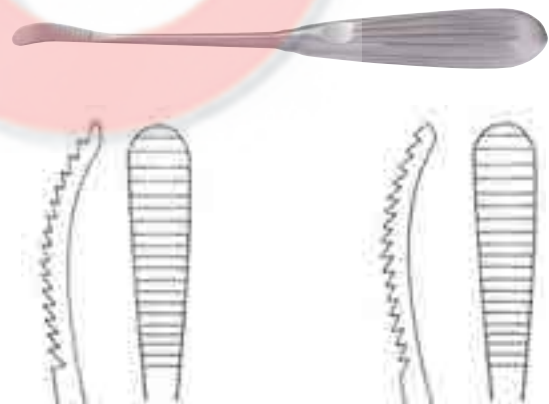

## MALTZ NASAL RASP

Down-cutting. Blade 35mm x 8mm wide.

<u>Item Number</u>	<u>Description</u>
MDS4650418	Overall length 6 3/4" (17.1cm)



## MALTZ-ANDERSON NASAL RASP

Up-cutting. Blade 38mm x 5.7mm wide.

<u>Item Number</u>	<u>Description</u>
MDS4650618	Overall length 6½" (16.5cm)

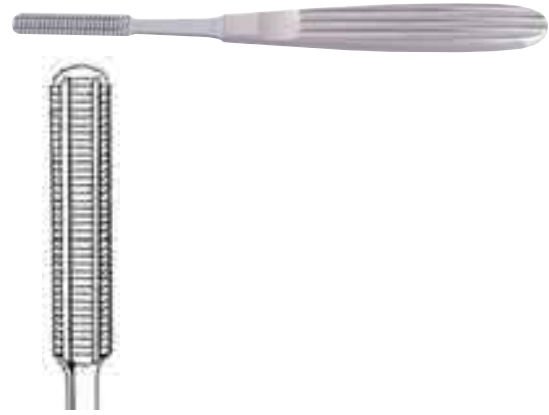

## GOOD ANTRUM RASP

Round and conical rasp for enlarging opening in all directions.

<u>Item Number</u>	<u>Description</u>
MDS0295441	Overall length 6¾" (17cm)



## LEWIS NASAL RASPS

Blade 19mm x 10mm wide.  
Overall length 7" (17.8cm).

<u>Item Number</u>	<u>Description</u>
MDS4651616	Coarse

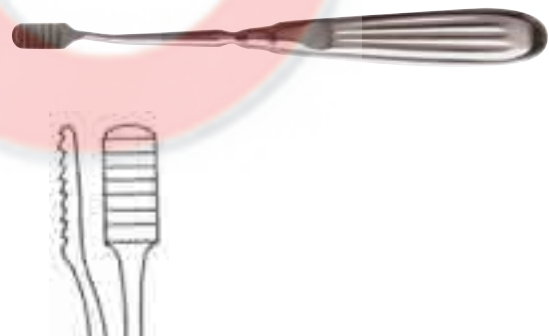

## DIAMOND RASPS

Overall length 7¼" (18.4cm).

<u>Item Number</u>	<u>Description</u>
MDS4642005	Straight, coarse grit
MDS4642006	Curved, coarse grit
MDS4642003	Straight, medium grit
MDS4642004	Curved, medium grit



## DOUBLE-ENDED RASPS

Tungsten carbide ends. Overall length 8<sup>1</sup>/<sub>4</sub>" (21cm).

<u>Item Number</u>	<u>Description</u>
MDS4640102	Grit 1 and 2
MDS4640034	Grit 3 and 4
MDS4640506	Grit 5 and 6
MDS4640708	Grit 7 and 8



## FOMON NASAL RASPS

Down-cutting. Double-ended. Each blade 4.2cm x 0.7cm wide. Overall length 8<sup>1</sup>/<sub>2</sub>" (21.6cm).

<u>Item Number</u>	<u>Description</u>
MDS4652021	Flat, double-sided, with three flat surfaces and one beveled surface
MDS4652010	Single-sided, fine teeth
MDS4652012	Single-sided, coarse teeth

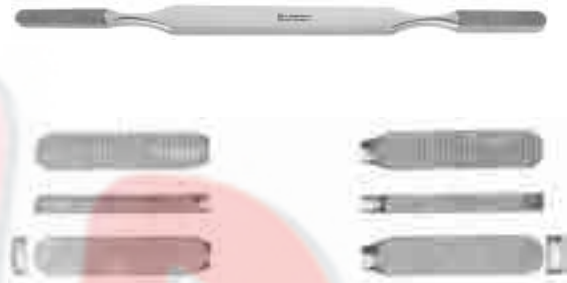

## COTTLE RASP OR SWEEPER

Hollow handle. Down-cutting.

<u>Item Number</u>	<u>Description</u>
MDS4651821	Overall length 8 <sup>1</sup> / <sub>2</sub> " (21.6cm)

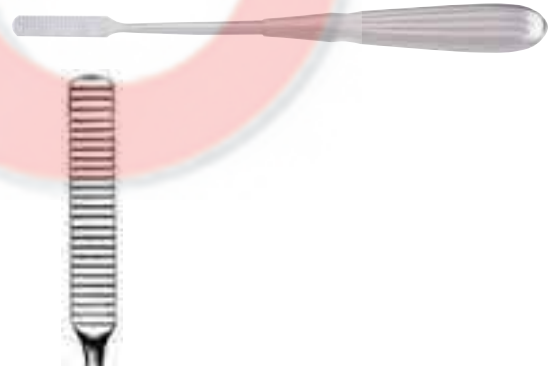

## WIENER-PIERCE ANTRUM TROCAR AND RASP

<u>Item Number</u>	<u>Description</u>
MDS4653530	Overall length 7 <sup>3</sup> / <sub>4</sub> " (19.7cm)



## COAKLEY SINUS CURETTES

Item Number	Description
MDS4660701	No. 1, slightly angled oval jaw, overall length 6½" (16.5cm)
MDS4660702	No. 2, oval jaw angled 45°, overall length 6¾" (16.2cm)
MDS4660706	No. 3, oval jaw angled 90°, overall length 5⅞" (14.9cm)
MDS4660704	No. 4, straight oval jaw, overall length 6½" (16.5cm)
MDS4660705	No. 5, oval jaw angled 45°, overall length 6¾" (16.2cm)
MDS4660707	No. 6, slightly angled triangular jaw, overall length 6½" (16.5cm)



## BARON SUCTION TUBES

Item Number	Description
MDS0040307	3Fr, working length 3" (7.6cm)
MDS0440311	3Fr, working length 4" (10.2cm)
MDS0440315	5Fr, working length 3" (7.6cm)
MDS4410205	5Fr, working length 4" (10.2cm)
MDS0440320	7Fr, working length 3" (7.6cm)
MDS0440317	7Fr, working length 4" (10.2cm)



## FRAZIER SUCTION TUBES

Angled, with finger valve and obturator.

Item Number	Description
MDS4029506	6Fr, working length 3⅞" (9.8cm)
MDS4029507	7Fr, working length 3⅞" (9.8cm)
MDS4029508	8Fr, working length 3⅞" (9.8cm)
MDS4029509	9Fr, working length 3⅞" (9.8cm)
MDS4029510	10Fr, working length 3⅞" (9.8cm)
MDS4029511	11Fr, working length 3⅞" (9.8cm)
MDS4029512	12Fr, working length 3⅞" (9.8cm)



## COTTLE COLUMELLA CLAMP

Jaws 11mm wide.

<u>Item Number</u>	<u>Description</u>
MDS1099210	Overall length 4 $\frac{1}{4}$ " (10.8cm)



## CARTILAGE CUTTING BOARD

PVC.

<u>Item Number</u>	<u>Description</u>
MDS4662242	Size 3" x 5" x $\frac{5}{8}$ " (7.6cm x 12.7cm x 1.6cm)



## METRIC RULER

Deeply etched with accurate scales.

<u>Item Number</u>	<u>Description</u>
MDS0234015	Length 6" (15cm)



## STRUEMPPEL-VOSS PEDIATRIC FORCEPS

Oval, fenestrated cup. Working length 4 $\frac{1}{8}$ " (10.5cm).  
Cup size 2.4mm.

<u>Item Number</u>	<u>Description</u>
MDS4427111	Straight
MDS4427109	Angled up 45°
MDS4427110	Angled up 90°



## TAKAHASHI NASAL FORCEPS

Working length 4½" (11.5cm).

<u>Item Number</u>	<u>Description</u>
MDS5113112	Jaws 8mm x 2.5mm wide
MDS4631301	Jaws 10mm x 4mm wide



## ADULT NASAL SCISSORS

Serrated blades. Working length 5⅛" (13cm).

<u>Item Number</u>	<u>Description</u>
MDS0204219	Straight
MDS0204239	Curved right
MDS0204229	Curved left



## BLAKESLEY-WEIL NASAL FORCEPS

Angled up 90°. Working length 4½" (11.5cm).

<u>Item Number</u>	<u>Description</u>
MDS0275949	3.5mm cup
MDS0397166	4mm cup
MDS0297171	5mm cup

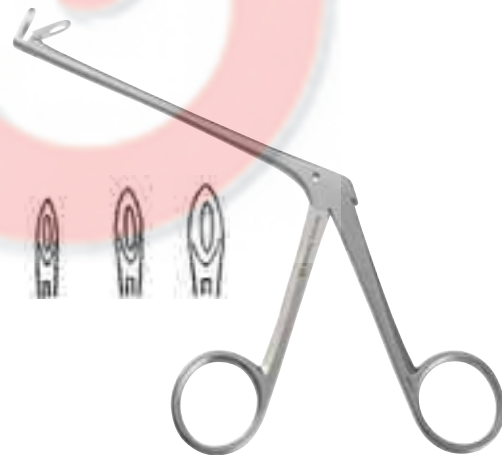

## BLAKESLEY NASAL FORCEPS

Up-turned 45°. Overall length 7" (17.8cm).

<u>Item Number</u>	<u>Description</u>
MDS4622301	No. 0, cup 8mm x 3.5mm wide
MDS4622302	No. 1, cup 11mm x 4mm wide
MDS4622303	No. 2, cup 12mm x 5mm wide



## BLAKESLEY-WEIL FORCEPS

Fenestrated cup 5mm x 2.5mm wide. No. 00.  
Working length 4½" (11.5cm).

<u>Item Number</u>	<u>Description</u>
--------------------	--------------------

MDS4623301	Straight
MDS4623302	Angled up 45°



## STRYUCKEN TURBINATE FORCEPS

Tips 1.5mm wide.

<u>Item Number</u>	<u>Description</u>
--------------------	--------------------

MDS4630591	Working length 4¾" (12cm)
------------	---------------------------



## BLAKESLEY-WEIL FORCEPS

Working length 4½" (11.5cm).

<u>Item Number</u>	<u>Description</u>
--------------------	--------------------

MDS4630681	Straight, No. 0, tip 3.5mm wide
MDS4630682	Straight, No. 1, tip 4mm wide
MDS4630683	Straight, No. 2, tip 5mm wide



## NASAL SUCTION FORCEPS

Double-action.

<u>Item Number</u>	<u>Description</u>
--------------------	--------------------

MDS4630351	Straight, No. 00, tip 2.5mm wide, working length 4¾" (12cm)
MDS4630352	Angled up, No. 00, tip 2.5mm wide, working length 4⅝" (11cm)
MDS4630353	Straight, No. 0, tip 3.5mm wide, working length 4¾" (12cm)
MDS4630354	Angled up, No. 0, tip 3.5mm wide, working length 4⅝" (11cm)
MDS4630355	Straight, No. 1, tip 4.85mm wide, working length 4¾" (12cm)
MDS4630356	Angled up, No. 1, tip 4.85mm wide, working length 4⅝" (11cm)





## BLAKESLEY THRU-CUT FORCEPS

Fenestrated. Serrated.

<b>Item Number</b>	<b>Description</b>
MDS4631091	Straight, No. 00, jaw width 2.5mm, working length 4 <sup>3</sup> / <sub>4</sub> " (12cm)
MDS4631092	Angled up 45°, No. 00, jaw 2.5mm wide, working length 4 <sup>3</sup> / <sub>8</sub> " (11cm)
MDS4631093	Straight, No. 0, jaw 3.5mm wide, working length 4 <sup>3</sup> / <sub>4</sub> " (12cm)
MDS4631094	Angled up 45°, No. 0, jaw 3.5mm wide, working length 4 <sup>3</sup> / <sub>8</sub> " (11cm)
MDS4631095	Straight, No. 1, jaw 5mm wide, working length 4 <sup>3</sup> / <sub>4</sub> " (12cm)
MDS4631096	Angled up 45°, No. 1, jaw 4mm wide, working length 4 <sup>3</sup> / <sub>4</sub> " (12cm)
MDS4631097	Angled right, No. 0, jaw 3.5mm wide, working length 4 <sup>3</sup> / <sub>4</sub> " (12cm)
MDS4631098	Angled left, No. 0, jaw 3.5mm wide, working length 4 <sup>3</sup> / <sub>4</sub> " (12cm)



## GIRAFFE FORCEPS

<b>Item Number</b>	<b>Description</b>
MDS4630852	Vertical, angled up 55°, 2mm double-action jaw, working length 5 <sup>1</sup> / <sub>2</sub> " (14cm)
MDS4630853	Vertical, angled up 90°, 2mm double-action jaw, working length 5 <sup>1</sup> / <sub>8</sub> " (13cm)
MDS4630855	Horizontal, angled up 55°, 2mm double-action jaw, working length 5 <sup>1</sup> / <sub>2</sub> " (14cm)
MDS4630856	Horizontal, angled up 90°, 2mm double-action jaw, working length 5 <sup>1</sup> / <sub>8</sub> " (13cm)
MDS4630854	Horizontal, angled up 55°, 3mm double-action jaw, working length 5 <sup>1</sup> / <sub>2</sub> " (14cm)
MDS4630851	Vertical, angled up 55°, 3mm double-action jaw, working length 5 <sup>1</sup> / <sub>2</sub> " (14cm)



## HUWEISER ANTRUM GRASPING FORCEPS

Working length 4" (10cm).

<b>Item Number</b>	<b>Description</b>
MDS4630901	Fixed jaws, curved 90°, movable jaw opens backward up to 120°



## BIOPSY AND GRASPING FORCEPS

Item Number	Description
MDS4630301	Vertical, angled up 70°, 3mm cup, working length 5½" (14cm)
MDS4630302	Vertical angled up 70°, 4mm cup, working length 5½" (14cm)
MDS4630303	Vertical angled up 110°, 3mm cup, working length 5" (12.5cm)
MDS4640304	Vertical angled up 110°, 4mm cup, overall length 5" (12.5cm)
MDS4630401	Horizontal double-action, angled up 70°, 3mm cup, working length 5½" (14cm)
MDS4630402	Horizontal angled up 70°, 4mm cup, working length 5½" (14cm)
MDS4630403	Horizontal double-action, angled up 110°, 3mm cup, working length 5" (12.5cm)
MDS4630404	Horizontal angled up 110°, 4mm cup, working length 4¾" (12.25cm)



## ROTATING OSTRUM PUNCH

Rotates 360°. Working length 4¾" (11cm).

Item Number	Description
MDS4631181	Cup 1.5mm wide
MDS4631182	Cup 2.5mm wide



## MICRO WILDE-TYPE BACK BITER

Jaw width 2mm.

Item Number	Description
MDS4631201	Straight, rotates 360°, working length 4¾" (11cm)
MDS4631202	Curved up, non-rotating, working length 3⅛" (8cm)
MDS4631203	Curved down, non-rotating, working length 3⅛" (8cm)

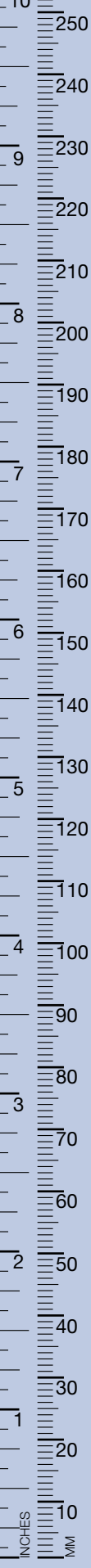

## BLAKESLEY PUNCH FORCEPS

Working length 4½" (11.5cm).

<b>Item Number</b>	<b>Description</b>
MDS4631291	Straight, No. 00, 2.5mm cup
MDS4631292	Angled, No. 00, 2.5mm cup
MDS4631301	Straight, No. 0, 3.5mm cup



## STAMMBERGER ANTRUM PUNCHES

Backward-cutting.

<b>Item Number</b>	<b>Description</b>
MDS4630101	Upside down, working length 4⅛" (10.5cm)
MDS4630102	Right side, working length 4⅛" (10.5cm)
MDS4630103	Left side, working length 4¼" (10.7cm)
MDS4630104	Slender, upside down, working length 4¾" (12cm)
MDS4630105	Slender, right side, working length 4¾" (12cm)
MDS4630106	Slender, left side, working length 4¾" (12cm)



## STAMMBERGER CIRCULAR PUNCHES

<b>Item Number</b>	<b>Description</b>
MDS4630452	3.5mm cup, straight, working length 7⅝" (19.5cm)
MDS4630453	3.5mm cup, angled up 70°, working length 7" (17.8cm)
MDS4630454	4.5mm cup, angled up 70°, working length 7¼" (18.5cm)



## STAMMBERGER ANTRUM PUNCHES

Tip 3mm wide. With flushing port.  
Working length 4<sup>1</sup>/<sub>4</sub>" (10.9cm).

<u>Item Number</u>	<u>Description</u>
MDS4630107	Right side cutting
MDS4630108	Left side cutting



## HAJEK-KOFFLER THRU-CUT PUNCH

Tip 2.5mm wide.

<u>Item Number</u>	<u>Description</u>
MDS6411622	Working length 6 <sup>1</sup> / <sub>2</sub> " (16.5cm)



## SICKLE KNIVES

Adult. Overall length 7<sup>1</sup>/<sub>2</sub>" (19cm).

<u>Item Number</u>	<u>Description</u>
MDS6430151	Straight, pointed blade, length 9mm
MDS6430152	Left, pointed blade, length 8.5mm
MDS6430153	Right, pointed blade, length 8.5mm
MDS6430154	Straight, rounded blade, length 10mm



## ANTRUM CURETTES

Overall length 7<sup>1</sup>/<sub>2</sub>" (19cm).

<u>Item Number</u>	<u>Description</u>
MDS4630204	Cup 5mm x 5mm wide
MDS4630205	Cup 6mm x 1.5mm wide
MDS6430206	Cup 10mm x 3mm wide
MDS6430201	Cup 10mm x 7mm wide
MDS6430203	Cup 10mm x 9mm wide
MDS6430202	Cup 13mm x 8mm wide



## FRONTAL SINUS CURETTES

Cup 5mm x 2mm wide.

<b>Item Number</b>	<b>Description</b>
MDS6430207	Cup angled 45°, overall length 7½" (19cm)
MDS6430208	Cup angled 90°, overall length 7¼" (18.3cm)
MDS643206S	Straight, overall length 7¾" (19.6cm)



## ANTRUM CURETTES

10mm x 7mm wide fenestrated cup, angled.  
Overall length 7½" (19cm).

<b>Item Number</b>	<b>Description</b>
MDS6430209	Forward-cutting
MDS6430210	Backward-cutting



## MAXILLARY SINUS OSTIUM SEEKER

Double ball-ended. Curved. 1.5mm and 2mm tips.

<b>Item Number</b>	<b>Description</b>
MDS6430251	Overall length 7½" (19cm)



## DOUBLE BALL-ENDED ELEVATOR

2.2mm and 2.5mm tips.

<b>Item Number</b>	<b>Description</b>
MDS6441411	Overall length 7⅝" (19.5cm)



## SINUS SUCTION TUBES

Item Number	Description
MDS6441436	Short curve, 2.5mm tip, overall length 6" (15cm)



## FRONTAL OSTIUM SEEKER

Double ball-ended. Curved.  
Right-angle ball hook on one end.

Item Number	Description
MDS6440502	Overall length 8 1/4" (21cm)



## SINUS SUCTION TUBES

Item Number	Description
MDS6431432	Short curve, 4mm tip, overall length 5 3/4" (14.5cm)
MDS6431434	Long curve, 5mm tip, overall length 5 1/2" (14.5cm)
MDS6431435	Long curve, 3.5mm tip, overall length 5 3/4" (14.5cm)
MDS6431431	Long curve, 4mm tip, overall length 5 3/4" (14.5cm)
MDS6431433	Short curve, 5mm tip, overall length 5 1/2" (14cm)
MDS6431437	Gentle curve, 2.4mm tip, overall length 6 1/8" (15.5cm).



## TROCAR AND CANNULAS

Item Number	Description
MDS6431481	Oblique end, 5mm trocar tip, overall length 6 1/2" (16.5cm)
MDS6431483	Oblique end, 4mm trocar tip, overall length 6 1/2" (16.5cm)
MDS6431484	Oblique end, 3mm trocar tip, overall length 6 7/8" (17.5cm)

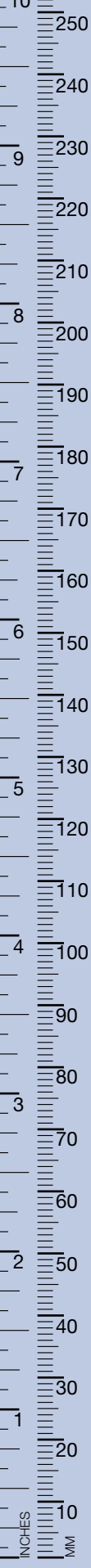

# Oral/Tonsil/ Bronchoscopic



König



## BARNHILL ADENOID CURETTES

Overall length 8½" (21.6cm).

<u>Item Number</u>	<u>Description</u>
MDS4663000	Size 0, 11mm
MDS4663001	Size 1, 13mm
MDS4663002	Size 2, 15mm
MDS4663003	Size 3, 17mm
MDS4663004	Size 4, 19mm



## VOGEL ADENOID CURETTE

Overall length 8½" (21.6cm).

<u>Item Number</u>	<u>Description</u>
MDS4661001	Infant size, 7mm



## REVERSE CURVE ADENOID CURETTES

Overall length 8½" (21.6cm).

<u>Item Number</u>	<u>Description</u>
MDS0893551	Size 0, 11mm
MDS0893556	Size 1, 13mm
MDS0893561	Size 2, 15mm
MDS0893566	Size 3, 17mm
MDS0893571	Size 4, 19mm

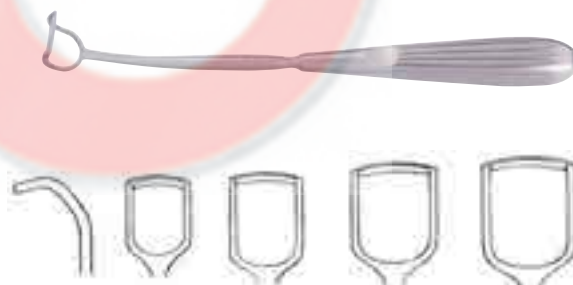

## JONES CURETTES

<u>Item Number</u>	<u>Description</u>
MDS0893661	Infant size, 4mm, overall length 8½" (21.2cm)
MDS0871444	Child size, 6mm, overall length 8¾" (22cm)
MDS0893671	Adult size, 8mm, overall length 9" (22.8cm)



## ROSENMUELLER FOSSAE CURETTE

Size 8mm.

Item Number	Description
MDS0893636	Overall length 9" (22.9cm)



## MELTZER ADENOID PUNCHES

Working length 4<sup>3</sup>/<sub>4</sub>" (12.1cm).

Item Number	Description
MDS4624536	Small round jaws, 6mm basket, 5mm bite
MDS4624497	Small triangular jaws, 7mm basket, 6mm bite
MDS4624496	Large round jaws, 8mm basket, 7mm bite
MDS4624499	Large triangular jaws, 9mm basket, 8mm bite



## MELTZER (RONIS) ADENOID PUNCHES

Curved shank. Triangular jaws.  
Overall length 5<sup>5</sup>/<sub>16</sub>" (13.5cm).

Item Number	Description
MDS4625011	6.3mm
MDS4625012	8mm



## ST. CLAIR-THOMPSON ADENOID FORCEPS

5mm x 10mm ring jaw.

Item Number	Description
MDS5018618	Overall length 7 <sup>1</sup> / <sub>4</sub> " (18.4cm)



## WEDER TONGUE DEPRESSORS

<u>Item Number</u>	<u>Description</u>
MDS4811501	Small, overall length 5½" (14cm)
MDS4811502	Large, overall length 6" (15.2cm)



MDS4811501



MDS4811502

## JENNINGS MOUTH GAGS

Self-retaining, with automatic ratchet lock.

<u>Item Number</u>	<u>Description</u>
MDS4827411	Infant size, overall length 6¼" (15.9cm)
MDS4827413	Child size, overall length 7" (17.8cm)
MDS4827415	Adult size, overall length 8" (20.3cm)



## SLUDER-JANSEN MOUTH GAG

Curved arms. Ratchet lock.

<u>Item Number</u>	<u>Description</u>
MDS4827420	Overall length 5½" (14cm)



## DINGMAN MOUTH GAGS

Item Number	Description
MDS4823000	Complete set, includes frame and three sizes of tongue blades
MDS4832301	Blade no. 1, 2½" x 1" (6.5cm x 2.5cm) wide
MDS4832302	Blade no. 2, 2¾" x 1¼" (7cm x 2.9cm) wide
MDS4832303	Blade no. 3, 3¼" x 1¼" (8.2cm x 3.2cm) wide
MDS4832310	Frame only



## MCIVOR MOUTH GAGS

Universal size, providing two-point contact on silicone covered ring. Easily adjustable.

Item Number	Description
MDS4832000	Complete with three sizes of blades, blade lengths are 6.8cm, 8.5cm and 9.5cm, all 25mm wide
MDS4832010	Frame only
MDS4832001	Blade no. 4, large, 3¾" x 1" (9.5cm x 2.5cm) wide
MDS4832002	Blade no. 3, medium, 3½" x 1" (8.5cm x 2.5cm) wide
MDS4832003	Blade no. 2½, small, 2⅝" x 1" (6.8cm x 2.5cm) wide



## DAVIS-CROWE MOUTH GAGS

Standard pattern, with double bite. Complete with frame.

Item Number	Description
MDS4840101	For patient's right
MDS4831000	For patient's left
MDS4838002	Frame only, for patient's right
MDS4831010	Frame only, for patient's left



## DAVIS-CROWE MOUTH GAG TONGUE DEPRESSOR BLADES

Item Number	Description
MDS4831002	No. 2, 6.5cm x 2.3cm wide
MDS4831008	No. 3, 8cm x 2.4cm wide
MDS4831009	No. 4, 9.3cm x 2.5cm wide
MDS4831001	No. 5, 10.8cm x 2.6cm wide



## DAVIS-CROWE MOUTH GAG TONGUE DEPRESSOR BLADES

Without tube.

Item Number	Description
MDS4831104	No. 2, 6.5cm x 2.6cm wide
MDS4831109	No. 3, 7.7cm x 2.7cm wide
MDS4831102	No. 4, 9cm x 2.7cm wide
MDS4831110	No. 5, 10cm x 2.7cm wide



## RING RETRACTOR BLADES

For use with the Davis-Crowe or McIvor mouth gag frame. A groove the full length of the blade holds the endotracheal tube, protects it from moving, kinking or closure by teeth. Four sizes, right and left.

Item Number	Description
MDS4840512	No. 2, right, 2 1/4" x 7/8" (5.7cm x 2.3cm) wide
MDS4840513	No. 3, right, 3" x 1 1/8" (7.2cm x 2.7cm) wide
MDS4840514	No. 4, right, 3 1/2" x 1 1/4" (8.8cm x 3.3cm) wide
MDS4840515	No. 5 right, 3 3/4" x 1 1/2" (9.5cm x 3.8cm)
MDS4831202L	No. 2, left, 2 1/4" x 7/8" (5.7cm x 2.3cm) wide
MDS4831203L	No. 3, left, 3" x 1 1/8" (7.2cm x 2.7cm) wide
MDS4831204L	No. 4, left, 3 1/2" x 1 1/4" (8.8cm x 3.3cm) wide
MDS4831205L	No. 5 left, 3 3/4" x 1 1/2" (9.5cm x 3.8cm)

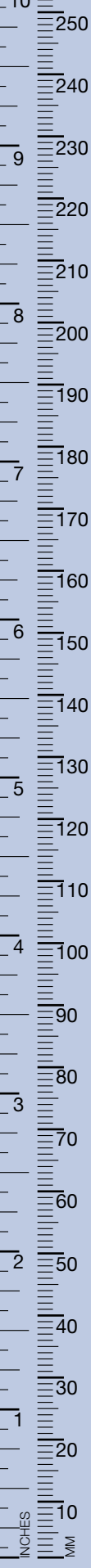

### BROPHY TENACULA

Sharp. Overall length 7<sup>3</sup>/<sub>4</sub>" (19.7cm).

<u>Item Number</u>	<u>Description</u>
MDS0868838	Heavy



### HURD TONSIL DISSECTOR AND PILLAR RETRACTOR

<u>Item Number</u>	<u>Description</u>
MDS5013310	Overall length 9" (22.5cm)



### WHITE TONSIL SEIZING FORCEPS

<u>Item Number</u>	<u>Description</u>
MDS5020523	Overall length 9 <sup>1</sup> / <sub>2</sub> " (24.0cm)

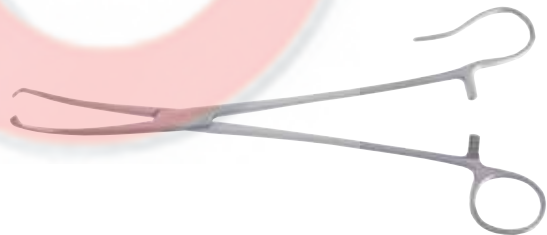

### WHITE-LILLIE TONSIL SEIZING FORCEPS

<u>Item Number</u>	<u>Description</u>
MDS5020518	Overall length 7 <sup>1</sup> / <sub>2</sub> " (19cm)



## MAGIELSKI TONSIL SEIZING FORCEPS

Two opposing rows of non-traumatic Allis-type teeth assure of firm grip.

<u>Item Number</u>	<u>Description</u>
MDS5020623	Overall length 7½" (19cm)



## TIVNEN TONSIL SEIZING FORCEPS

Guard on lock prevents over-riding of 3 x 3 prongs.

<u>Item Number</u>	<u>Description</u>
MDS5021321	Overall length 8½" (21.6cm)



## COLVER TONSIL PILLAR GRASPING FORCEPS

5 x 6 teeth.

<u>Item Number</u>	<u>Description</u>
MDS5020219	Overall length 7⅝" (19.4cm)

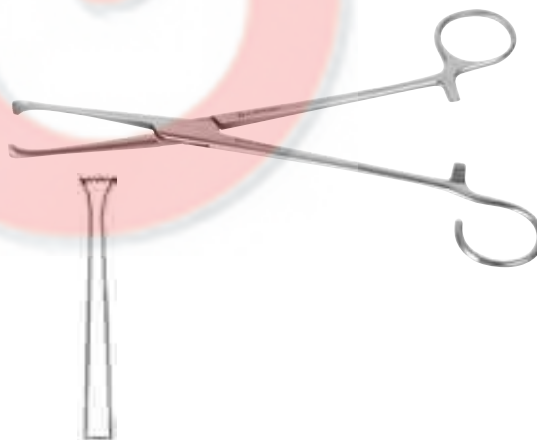

## CUT SNARE WIRES

Overall length 4" (10.2cm). Available by the gross (144).

<u>Item Number</u>	<u>Description</u>
MDS5026707	Size 7, diameter .43mm
MDS5026708	Size 8, diameter .48mm





## EVES TONSIL SNARES

Includes 12 wires. Overall length 11 $\frac{1}{8}$ " (28.3cm).

<u>Item Number</u>	<u>Description</u>
MDS5025228	With ratchet
MDS5025028	Without ratchet

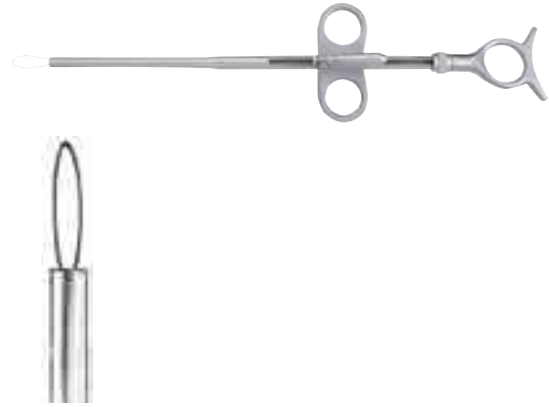

## TYDINGS TONSIL SNARE

One-piece model.

<u>Item Number</u>	<u>Description</u>
MDS5026000	Working length 6 $\frac{5}{8}$ " (16.9cm)



## BOETTCHER (SCHNIDT) TONSIL ARTERY FORCEPS

Slightly curved jaws.

<u>Item Number</u>	<u>Description</u>
MDS5018319	Overall length 7 $\frac{1}{2}$ " (19cm)

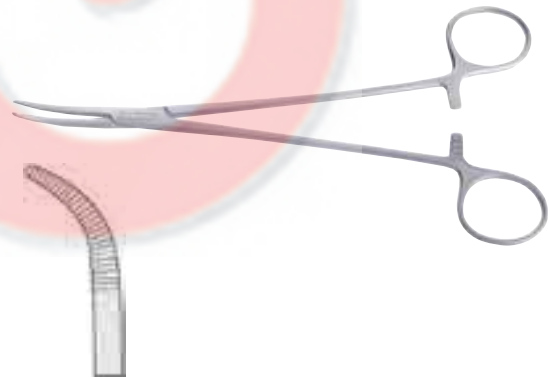

## SAWTELL TONSIL ARTERY FORCEPS

Fully curved jaws.

<u>Item Number</u>	<u>Description</u>
MDS5018119	Overall length 7 $\frac{1}{2}$ " (19cm)



## COLVER TONSIL KNIFE

Serrated blade.

<u>Item Number</u>	<u>Description</u>
MDS5030101	Overall length 7½" (19cm)



## FISHER TONSIL KNIFE AND DISSECTOR

Blunt end, semi-sharp anterior edge and semi-sharp teeth.

<u>Item Number</u>	<u>Description</u>
MDS5030122	Overall length 8¼" (21cm)



## BALLENGER SPONGE HOLDING FORCEPS

Overall length 7" (17.8cm).

<u>Item Number</u>	<u>Description</u>
MDS1617018	Straight, serrated loop jaws
MDS1617218	Straight, smooth loop jaws
MDS1617118	Curved, serrated loop jaws
MDS1617318	Curved, smooth loop jaws

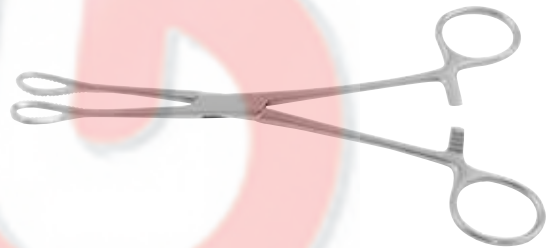

## METZENBAUM DISSECTING SCISSORS

Dissecting blades. Blunt/blunt. Overall length 7" (17.8cm).

<u>Item Number</u>	<u>Description</u>
MDS0828018	Straight
MDS0828118LH	Slightly curved-on-flat, left-handed
MDS0828118	Slightly curved-on-flat



### METZENBAUM DISSECTING SCISSORS

Light model. Fine, narrow blades are curved for delicate dissections. Mirror finish.

<u>Item Number</u>	<u>Description</u>
MDS0828318	Overall length 7 <sup>3</sup> / <sub>8</sub> " (18.7cm)

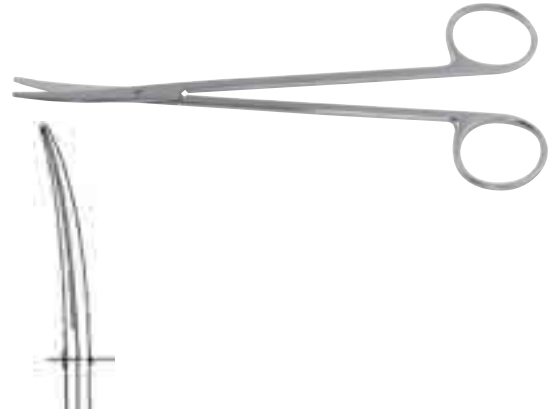

### BOETTCHER SCISSORS

Curved double-edged blades. Mirror finish.

<u>Item Number</u>	<u>Description</u>
MDS0843518	Overall length 7 <sup>1</sup> / <sub>2</sub> " (19cm)



### LILLIE SCISSORS

Blades curved-on-flat. Mirror finish.

<u>Item Number</u>	<u>Description</u>
MDS0851420	Overall length 8" (20.3cm)



### SUPER CUT METZENBAUM DISSECTING SCISSORS

Curved. Black handles. Mirror finish.  
Overall length 7" (17.8cm).

<u>Item Number</u>	<u>Description</u>
MDS0728118	Dissecting blades slightly curved-on-flat
MDS0728318	Fine



## DEAN SCISSORS

Angled blades. One blade serrated.  
Handles slightly curved.

<u>Item Number</u>	<u>Description</u>
MDS0842717	Overall length 6 <sup>3</sup> / <sub>4</sub> " (17.1cm)



## BLAIR-BROWN NEEDLE HOLDER

For fine needles and sutures.

<u>Item Number</u>	<u>Description</u>
MDS0151536	Overall length 5 <sup>1</sup> / <sub>4</sub> " (13.3cm)

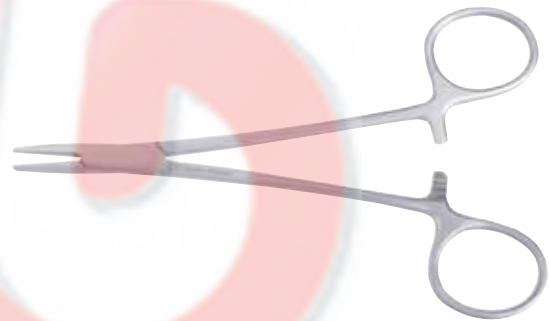

## METZENBAUM TONSIL NEEDLE HOLDER

Slotted, curved jaws.

<u>Item Number</u>	<u>Description</u>
MDS2429018	Overall length 7 <sup>1</sup> / <sub>8</sub> " (18.1cm)



### CARMODY TISSUE FORCEPS

Fine serrations on jaws. 1 x 2 teeth. Mirror finish.

Item Number	Description
MDS1020216	Overall length 6 <sup>1</sup> / <sub>4</sub> " (15.9cm)



### BROWN TISSUE FORCEPS

7 x 8 teeth.

Item Number	Description
MDS1018915	Overall length 6" (15.2cm)
MDS1018920	Overall length 8" (20.3cm)



### SCHMEDEN TONSIL PUNCH

Triangular jaws. 12.7mm x 9.7mm wide.

Item Number	Description
MDS4636203	Working length 5 <sup>1</sup> / <sub>2</sub> " (14cm)



## EXTRACTING FORCEPS

<u>Item Number</u>	<u>Description</u>
--------------------	--------------------

MDS4900151	No. 151
MDS490151A	No. 151A
MDS4900222	No. 222



MDS490151A



MDS4900222

## EXTRACTING FORCEPS

<u>Item Number</u>	<u>Description</u>
--------------------	--------------------

MDS490017C	No. 17C
------------	---------

## EXTRACTING FORCEPS

<u>Item Number</u>	<u>Description</u>
--------------------	--------------------

MDS4900035	No. 35
------------	--------



## EXTRACTING FORCEPS

<u>Item Number</u>	<u>Description</u>
--------------------	--------------------

MDS490053R	No. 53R
------------	---------



## EXTRACTING FORCEPS

<u>Item Number</u>	<u>Description</u>
MDS490074N	No. 74N
MDS49074XN	No. 74XN
MDS490151S	No. 151S



MDS490151S

## EXTRACTING FORCEPS

<u>Item Number</u>	<u>Description</u>
MDS4900062	No. 62



## EXTRACTING FORCEPS

<u>Item Number</u>	<u>Description</u>
MDS4900085	No. 85



## EXTRACTING FORCEPS

<u>Item Number</u>	<u>Description</u>
MDS490085A	No. 85A



## EXTRACTING FORCEPS

<u>Item Number</u>	<u>Description</u>
MDS4900086	No. 86
MDS4900073	No. 73
MDS4900MD3	No. MD3
MDS4900013	No. 13



MDS4900073



MDS4900MD3

## EXTRACTING FORCEPS

<u>Item Number</u>	<u>Description</u>
MDS4900087	No. 87, English pattern
MDS4900022	No. 22, English pattern



MDS4900087



MDS4900022

## EXTRACTING FORCEPS

<u>Item Number</u>	<u>Description</u>
MDS490099A	No. 99A



## EXTRACTING FORCEPS

<u>Item Number</u>	<u>Description</u>
MDS490099C	No. 99C



## EXTRACTING FORCEPS

Item Number	Description
MDS4900MD1	No. MD1
MDS4900MD2	No. MD2



MDS4900MD1



MDS4900MD2

## EXTRACTING FORCEPS

Item Number	Description
MDS490150SK	No. 150SK



## EXTRACTING FORCEPS

Item Number	Description
MDS490150X	No. 150X



## EXTRACTING FORCEPS

Item Number	Description
MDS490151SK	No. 151SK



Item Number	Description
MDS49017SK	No. 17SK

## EXTRACTING FORCEPS

<u>Item Number</u>	<u>Description</u>
MDS49023SK	No. 23SK



## EXTRACTING FORCEPS

<u>Item Number</u>	<u>Description</u>
MDS4900023	No. 23



## EXTRACTING FORCEPS

<u>Item Number</u>	<u>Description</u>
MDS4900006	No. 6
MDS490150S	No. 150S



MDS4900006



MDS490150S

## EXTRACTING FORCEPS

<u>Item Number</u>	<u>Description</u>
MDS4900101	No. 101



## EXTRACTING FORCEPS

Item Number	Description
MDS490010S	No. 10S



## EXTRACTING FORCEPS

Item Number	Description
MDS4900016	No. 16
MDS4900203	No. 203



MDS4900016



MDS4900203

## EXTRACTING FORCEPS

Item Number	Description
MDS4900017	No. 17
MDS4900001	No. 1
MDS490001A	No. 1A
MDS4900150	No. 150
MDS490150A	No. 150A



MDS4900001



MDS490001A



MDS4900150

## EXTRACTING FORCEPS

Item Number	Description
MDS490150AS	No. 150AS

## EXTRACTING FORCEPS

Item Number	Description
MDS490150C	No. 150C

## EXTRACTING FORCEPS

<b>Item Number</b>	<b>Description</b>
MDS490018L	No. 18L
MDS4900286	No. 286
MDS490053L	No. 53L
MDS4900069	No. 69



MDS490018L



MDS4900286



MDS490053L



MDS4900069

## EXTRACTING FORCEPS

<b>Item Number</b>	<b>Description</b>
MDS490088L	No. 88L
MDS490088R	No. 88R



MDS490088R

## EXTRACTING FORCEPS

<b>Item Number</b>	<b>Description</b>
MDS4900065	No. 65



## EXTRACTING FORCEPS

<b>Item Number</b>	<b>Description</b>
MDS490001B	No. 1B



## EXTRACTING FORCEPS

<u>Item Number</u>	<u>Description</u>
MDS4900103	No. 103



## EXTRACTING FORCEPS

<u>Item Number</u>	<u>Description</u>
MDS490010H	No. 10H



## EXTRACTING FORCEPS

<u>Item Number</u>	<u>Description</u>
MDS4900015	No. 15



## EXTRACTING FORCEPS

<u>Item Number</u>	<u>Description</u>
MDS490018R	No. 18R



## EXTRACTING FORCEPS

<u>Item Number</u>	<u>Description</u>
MDS4900201	No. 201



## EXTRACTING FORCEPS

<u>Item Number</u>	<u>Description</u>
MDS490210H	No. 210H



## EXTRACTING FORCEPS

<u>Item Number</u>	<u>Description</u>
MDS490210S	No. 210S



## EXTRACTING FORCEPS

<u>Item Number</u>	<u>Description</u>
MDS4900024	No. 24





## EXTRACTING FORCEPS

<u>Item Number</u>	<u>Description</u>
MDS4900028	No. 28

## EXTRACTING FORCEPS

<u>Item Number</u>	<u>Description</u>
MDS4900288	No. 288

## EXTRACTING FORCEPS

<u>Item Number</u>	<u>Description</u>
MDS4900032	No. 32



## EXTRACTING FORCEPS

<u>Item Number</u>	<u>Description</u>
MDS490032A	No. 32A



## EXTRACTING FORCEPS

<u>Item Number</u>	<u>Description</u>
MDS4900033	No. 33



## UNIVERSITY OF MINNESOTA-TYPE CHEEK RETRACTOR/TONGUE DEPRESSOR

Item Number	Description
MDS4820114	Overall length 5½" (14cm)



## OBWEGESER-TYPE TISSUE RETRACTORS

Flat blade. Overall length 8¾" (22.2cm).

Item Number	Description
MDS1370816	Curved down, 25mm x 7mm wide
MDS1368449	Curved down, 42mm x 10mm wide
MDS1358444	Curved down, 55mm x 12mm wide
MDS1358459	Curved down, 70mm x 14mm wide
MDS1358454	Curved down, 80mm x 16mm wide
MDS1370771	Curved up, 42mm x 13mm wide
MDS1370841	Curved up, 60mm x 12mm wide
MDS1370786	Curved up, 80mm x 16mm wide



## OBWEGESER-TYPE SOFT TISSUE RETRACTORS

Concave blade. Overall length 8¾" (22.2cm).

Item Number	Description
MDS1278456	Curved down, 16mm x 5mm wide
MDS1270816	Curved down, 25mm x 7mm wide
MDS1270821	Curved down, 35mm x 10mm wide
MDS1258449	Curved down, 42mm x 10mm wide
MDS1270831	Curved down, 55mm x 12mm wide
MDS1258459	Curved down, 70mm x 14mm wide
MDS1270841	Curved down, 80mm x 16mm wide
MDS1270761	Curved up, 25mm x 7mm wide
MDS1270766	Curved up, 35mm x 10mm wide
MDS1270771	Curved up, 42mm x 10mm wide
MDS1270776	Curved up, 55mm x 12mm wide
MDS1270781	Curved up, 70mm x 14mm wide
MDS1270786	Curved up, 80mm x 16mm wide



## OBWEGESER-TYPE RAMUS RETRACTORS

Curved. Conclave blade. Overall length 8<sup>3</sup>/<sub>4</sub>" (22.2cm).

<u>Item Number</u>	<u>Description</u>
MDS1270911	70mm x 15mm wide
MDS1270916	70mm x 22mm wide



## OBWEGESER-TYPE RAMUS RETRACTOR

Curved. Flat blade. Overall length 8<sup>3</sup>/<sub>4</sub>" (22.2cm).

<u>Item Number</u>	<u>Description</u>
MDS1280911	70mm x 11mm wide



## OBWEGESER-TYPE MANDIBULAR CHANNEL RETRACTORS

Overall length 6<sup>3</sup>/<sub>4</sub>" (17.1cm).

<u>Item Number</u>	<u>Description</u>
MDS1281008	8mm wide
MDS1281010	10mm wide



## OBWEGESER-TYPE NASAL SPINE RETRACTOR

Overall length 8<sup>3</sup>/<sub>4</sub>" (22.2cm).

<u>Item Number</u>	<u>Description</u>
MDS1270061	Straight, flat blade, 42mm x 10mm wide



## OBWEGESER-TYPE CHIN RETRACTOR

<u>Item Number</u>	<u>Description</u>
MDS1270506	Overall length 6 $\frac{1}{8}$ " (15.5cm)



## SEWELL ORBITAL RETRACTORS

No slot, overall length 6 $\frac{1}{4}$ " (15.9cm).

<u>Item Number</u>	<u>Description</u>
MDS1293525	Blade 7mm x 52mm wide
MDS1293524	Blade 9mm x 51mm wide
MDS1293523	Blade 11mm x 50mm wide
MDS1293522	Blade 13mm x 67mm wide



## HARGIS-TYPE MANDIBULAR BODY RETRACTOR

<u>Item Number</u>	<u>Description</u>
MDS1281461	Overall length 7" (18cm)



## SMITH SAGITTAL-TYPE SPLIT SEPARATORS

9mm x 10mm wide. Overall length 7" (17.8cm).

<u>Item Number</u>	<u>Description</u>
MDS1289650	Curved right
MDS1289655	Curved left



## SMITH-TYPE RAMUS SEPARATOR

Overall length 8" (20.3cm).

Item Number	Description
MDS1289660	Blade 12mm



## MOLT-TYPE EXODONTIA ORAL CURETTE

Double-ended. Overall length 7" (17.8cm).

Item Number	Description
MDS779124	Size 2-4



## EPKER-TYPE OSTEOTOMES

Overall length 7" (17.8cm).

Item Number	Description
MDS1297886	Straight, 1.2mm x 4mm wide
MDS1297896	Straight, 1.2mm x 6mm wide
MDS1297899	Straight, 1.2mm x 8mm wide
MDS1297918	Sharply curved, 1.2mm x 6mm wide
MDS1297916	Sharply curved, 1.2mm x 8mm wide



## OBWEGESER-TYPE NASAL OSTEOTOME

Overall length 7 1/2" (19cm).

Item Number	Description
MDS1297941	Ball tips



## OBWEGESER-TYPE SPLITTING OSTEOTOMES

Overall length 8<sup>3</sup>/<sub>4</sub>" (22.2cm).

<u>Item Number</u>	<u>Description</u>
MDS1298265	Blade 8mm wide
MDS1298266	Blade 12mm wide
MDS1298267	Blade 16mm wide



## TESSIER-TYPE MAXILLARY LEVERS

Blade 9mm wide. Overall length 6" (15.2cm).

<u>Item Number</u>	<u>Description</u>
MDS1216551	Right
MDS1216556	Left



## ORAL SURGERY ELEVATORS

Angled. Overall length 6" (15.2cm).

<u>Item Number</u>	<u>Description</u>
MDS1210072	No. 73
MDS1210073	No. 74



## POTTS-TYPE EXODONTIA ORAL SURGERY ELEVATORS

Overall length 6" (15.2cm).

<u>Item Number</u>	<u>Description</u>
MDS1215151	No. 1, right
MDS1215156	No. 2, left



## COGSWELL-TYPE EXODONTIA ORAL ELEVATORS

Overall length 6" (15.2cm).

Item Number	Description
MDS1213541	Straight
MDS1294146	Angled



## CRYER-TYPE EXONDONTIA ORAL SURGERY ELEVATORS

Overall length 6" (15.2cm).

Item Number	Description
MDS1213691	No. 31
MDS1213696	No. 32



## CRANE-TYPE EXODONTIA ORAL PICK ELEVATOR

Overall length 6" (15.2cm).

Item Number	Description
MDS1213491	Angled



## PERIOSTEAL ELEVATOR

Overall length 7" (17.8cm).

Item Number	Description
MDS1211856	No. 856





## SELDIN-TYPE PERIOSTEAL ELEVATOR

No. 23. Overall length 7<sup>3</sup>/<sub>4</sub>" (19.7cm).

<u>Item Number</u>	<u>Description</u>
--------------------	--------------------

MDS1211816	Flat handle
------------	-------------



## MOLT-TYPE PERIOSTEAL ELEVATOR

Overall length 7<sup>1</sup>/<sub>4</sub>" (18.4cm).

<u>Item Number</u>	<u>Description</u>
--------------------	--------------------

MDS1211886	No. 9
------------	-------



## PERIOSTEAL ELEVATOR

Hexagonal handle. Double-ended.  
Overall length 7" (17.8cm).

<u>Item Number</u>	<u>Description</u>
--------------------	--------------------

MDS1211896	No. 9H
------------	--------



## OBWEGESER-TYPE PERIOSTEAL ELEVATORS

Flat. Overall length 7" (17.8cm).

<u>Item Number</u>	<u>Description</u>
--------------------	--------------------

MDS1212361	Blade 6mm wide
------------	----------------

MDS1212391	Blade 7mm wide
------------	----------------

MDS1212371	Blade 9mm wide
------------	----------------

MDS1212376	Blade 11mm wide
------------	-----------------



## FREER-TYPE (MODIFIED) ELEVATORS

Double-ended. Sharp. Overall length 8½" (21.6cm).

Item Number	Description
MDS1211951	Slightly curved
MDS1211956	Strongly curved



## OBWEGESER-FREER-TYPE PERIOSTEAL ELEVATOR

Double-ended. Blunt/blunt. Overall length 8½" (21.6cm).

Item Number	Description
MDS1211936	Tip 6mm wide



## GILLIES-TYPE MALAR ELEVATOR

Overall length 9" (22.9cm).

Item Number	Description
MDS0291411	Large handle



## ROWE-TYPE DISIMPACTION FORCEPS

Overall length 9½" (24.1cm).

Item Number	Description
MDS1291611	Right
MDS1291616	Left



## ORAL BONE FILES

Double-ended. One end 5mm rounded and one end 7mm rounded. Overall length 7<sup>1</sup>/<sub>4</sub>" (18.4cm).

<u>Item Number</u>	<u>Description</u>
MDS1880152	Serrated
MDS1880416	Cross-serrated



## OBWEGESER-TYPE MANDIBULAR AWLS

Curved.

<u>Item Number</u>	<u>Description</u>
MDS1202176	Small, overall length 6" (15.2cm)
MDS1202191	Large, overall length 7 <sup>1</sup> / <sub>8</sub> " (18.1cm)



## OBWEGESER-TYPE ZYGOMATIC ARCH AWL

<u>Item Number</u>	<u>Description</u>
MDS1202221	Overall length 9" (23cm)



## OBWEGESER-TYPE MAXILLARY AWL

Slightly curved.

<u>Item Number</u>	<u>Description</u>
MDS1202101	Overall length 7" (18cm)



### WIRE-CUTTING SCISSORS

Overall length 4<sup>3</sup>/<sub>4</sub>" (12.1cm).

Item Number	Description
MDS0883112	Blades angled-to-side



### WIRE-CUTTING SCISSORS

Overall length 4<sup>3</sup>/<sub>4</sub>" (12.1cm).

Item Number	Description
MDS0885012	Straight blades
MDS0885112	Curved blades



### CASTROVIEJO-TYPE CALIPER

Straight. 0-40mm.

Item Number	Description
MDS1800441	Overall length 7" (17.8cm)



### SMITH-TYPE WIRE CUTTING SCISSORS

Maximum cutting capacity 0.3mm for hard wire and 0.6mm for soft wire.

Item Number	Description
MDS0806817	Overall length 6 <sup>1</sup> / <sub>4</sub> " (15.9cm)



## WIRE-TWISTING FORCEPS

<u>Item Number</u>	<u>Description</u>
MDS0665211	Overall length 6 <sup>3</sup> / <sub>4</sub> " (17.1cm)



## JACKSON TRACHEAL TENACULUM

<u>Item Number</u>	<u>Description</u>
MDS5411615	Overall length 5 <sup>3</sup> / <sub>4</sub> " (14.6cm)



## TROUSSEAU-JACKSON TRACHEAL DILATOR

Two probe-pointed blades.

<u>Item Number</u>	<u>Description</u>
MDS5411114	Overall length 5 <sup>1</sup> / <sub>2</sub> " (14cm)



## LABORDE TRACHEAL DILATOR

Three prongs.

<u>Item Number</u>	<u>Description</u>
MDS5411314	Overall length 5 <sup>1</sup> / <sub>2</sub> " (14cm)

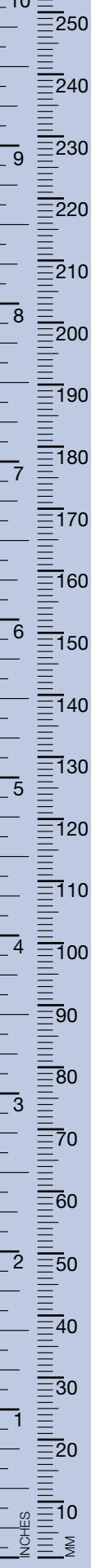

## JACKSON TRACHEAL HEMOSTATIC FORCEPS

Full curved, serrated jaws.

Item Number	Description
MDS5499314	Overall length 5½" (14cm)



## TRACHEAL RETRACTORS

Overall length 6¼" (15.9cm).

Item Number	Description
MDS1822002	2 sharp prongs
MDS1822003	3 sharp prongs
MDS1822102	2 blunt prongs
MDS1822103	3 blunt prongs



MDS1822002 MDS1822003 MDS1822102 MDS1822103

## LUKENS THYMUS RETRACTOR

Double-ended. Blades 12mm and 8mm wide.

Item Number	Description
MDS4007517	Overall length 6¾" (17.1cm)



## JACKSON TRACHEAL RETRACTOR

Double-ended. Flat blade ¾" (1cm) wide on one end, two prongs on the other end.

Item Number	Description
MDS5411717	Overall length 7" (17.8cm)



## NEW'S TRACHEOTOMY HOOK

<u>Item Number</u>	<u>Description</u>
MDS5413115	Overall length 6 $\frac{1}{2}$ " (16.5cm)



## ANDREWS-PYNCHON SUCTION TUBE

Smaller modification of the Pynchon tube. Mirror finish.

<u>Item Number</u>	<u>Description</u>
MDS0415222	Overall length 8 $\frac{5}{8}$ " (22cm)



## JACKSON LARYNGEAL ATOMIZER

Spray tube length 4" (10.2cm). Partially chrome plated.

<u>Item Number</u>	<u>Description</u>
MDS0400670	Glass bottle-style supplied as available, overall length 9" (22.9cm)



## MEDIASTINOSCOPY ASPIRATING NEEDLE

22GA. Mirror finish.

<u>Item Number</u>	<u>Description</u>
MDS4488230	Working length 8 $\frac{1}{2}$ " (22cm)





## JAKO MICROLARYNGEAL GRASPING FORCEPS

Grasping tip 1.5mm x 8.5mm wide.  
Working length 9½" (24cm).

Item Number	Description
MDS4481501	Straight, pass diameter 3.5mm
MDS4481503	Angled left, pass diameter 5mm
MDS4481502	Angled right, pass diameter 5mm

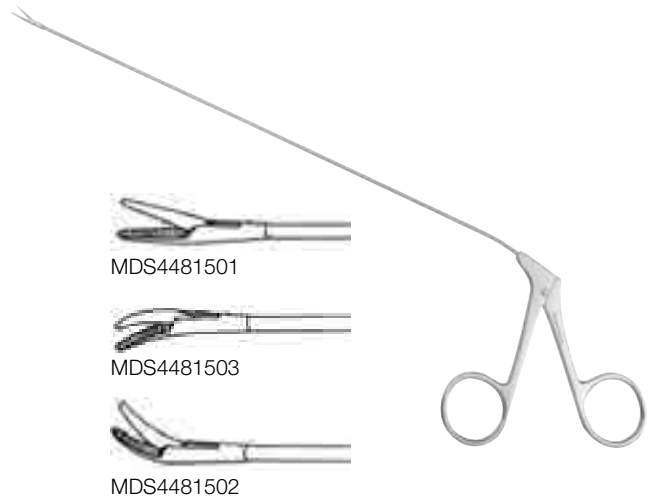

## JAKO MICROLARYNGEAL CUP-SHAPED FORCEPS

Cup diameter 2.5mm. Pass diameter 4.5mm.  
Working length 9½" (24cm).

Item Number	Description
MDS4481301	Straight
MDS4481303	Angled left
MDS4481302	Angled right

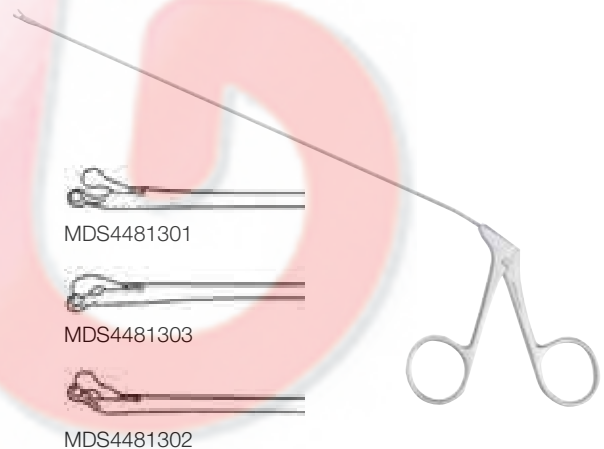

## JAKO MICROLARYNGEAL SCISSORS

Blade length 6mm. Working length 9¼" (23.5cm).

Item Number	Description
MDS4487144	Straight, vertical
MDS4442301	Straight, horizontal
MDS4442302	Angled left
MDS4422304	Angled right
MDS4442300	Angled up

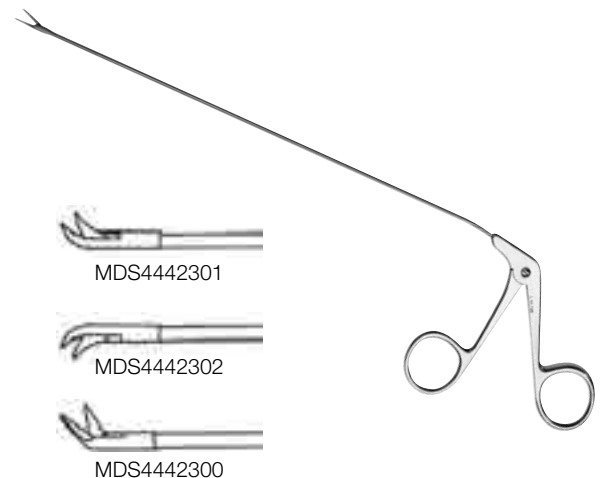

## JAKO LARYNGEAL SUCTION TUBE

7Fr. Open-ended.

<u>Item Number</u>	<u>Description</u>
MDS4482321	Working length 8 <sup>5</sup> / <sub>8</sub> " (22cm)



## JACKSON VELVET EYE ASPIRATING TUBE

Distal tip has a smooth, oval-shaped opening on each side in opposing positions, and a closed blunt end.

<u>Item Number</u>	<u>Description</u>
MDS0429110	Diameter 4mm, overall length 10" (25.4cm)



## JACKSON OPEN-END ASPIRATING TUBE

Diameter 4mm.

<u>Item Number</u>	<u>Description</u>
MDS0429310	Overall length 10" (25.4cm)

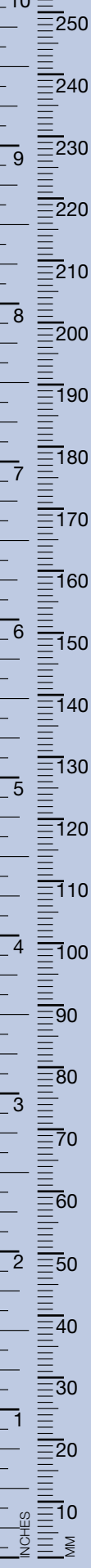

## JACKSON LARYNGEAL FORCEPS

Cross-action.

<u>Item Number</u>	<u>Description</u>
MDS5210122	Serrated, toothed jaw

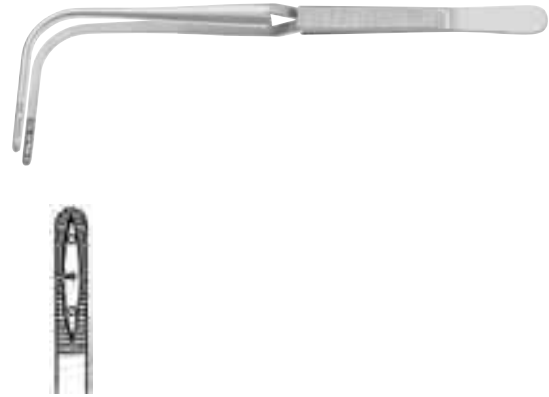

## PATTERSON LARYNGEAL FORCEPS

Cup-shaped jaws. 12mm x 4mm wide.

<u>Item Number</u>	<u>Description</u>
MDS4440336	Working length 11" (28cm)



## JACKSON LARYNGEAL GRASPING FORCEPS

Alligator-style. Grasping tip 20mm x 4mm wide.  
Pass diameter 5mm.

<u>Item Number</u>	<u>Description</u>
MDS4442351	Working length 14 <sup>1</sup> / <sub>8</sub> " (35.9cm)



## JACKSON LARYNGEAL FORCEPS

Fine. Straight cup.

<u>Item Number</u>	<u>Description</u>
MDS4442420	2mm, working length 11" (28cm)
MDS4442421	4mm, working length 11 <sup>1</sup> / <sub>2</sub> " (29.2cm)
MDS4442424	4mm, working length 18 <sup>7</sup> / <sub>8</sub> " (48cm)
MDS4442422	5mm, working length 11" (28cm)
MDS4442423	6mm, working length 11" (28cm)



## JACKSON LARYNGEAL FORCEPS

Fine.

<u>Item Number</u>	<u>Description</u>
MDS4442430	2mm angled cup, working length 11" (28cm)
MDS4442431	4mm angled cup, working length 11" (28cm)

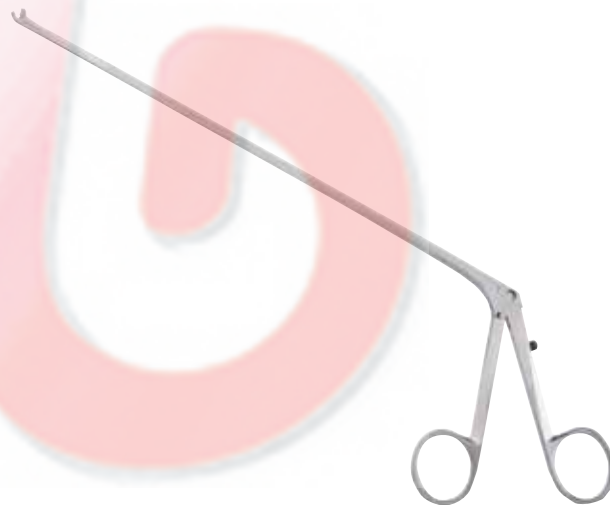

## ALLIGATOR GRASPING FORCEPS

Extra-small size, fine. Grasping tip 8mm x 3mm wide.  
Pass diameter 4mm.

<u>Item Number</u>	<u>Description</u>
MDS4442480	Working length 11" (28cm)

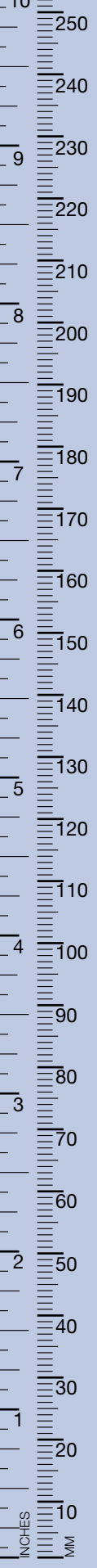
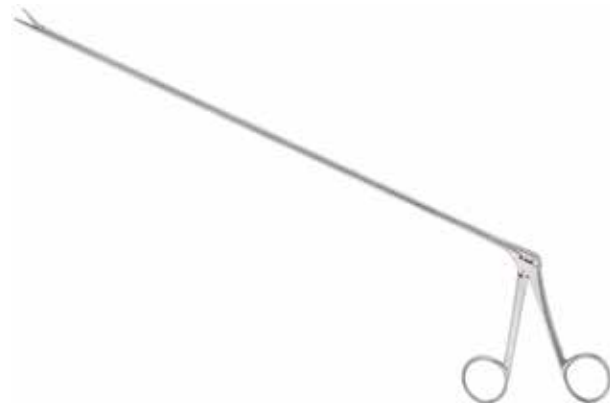

# Ophthalmic

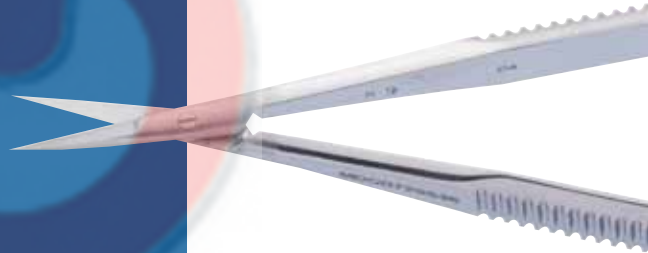

König

## BARRAQUER WIRE SPECULUM

<u>Item Number</u>	<u>Description</u>
MDS0765635	Wire blades 1.3cm x 6mm x 8mm wide, overall length 1 <sup>5</sup> / <sub>8</sub> " (4cm)
MDS0787855	Wire blades 1cm x 6mm x 8mm wide, overall length 1 <sup>1</sup> / <sub>2</sub> " (3.8cm)

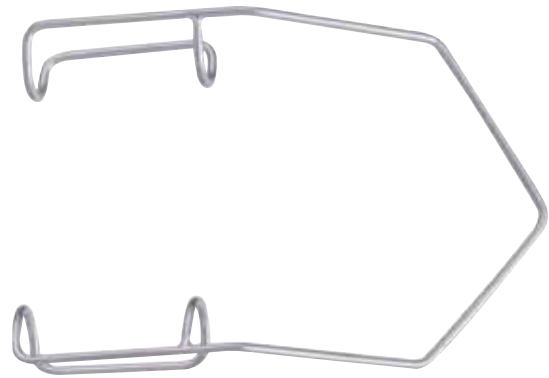

## BARRAQUER WIRE SPECULUM

Overall length 1<sup>1</sup>/<sub>2</sub>" (3.8cm).

<u>Item Number</u>	<u>Description</u>
MDS0786875	Solid blades 1.5cm x 5mm x 7mm wide
MDS0787871	Solid blades 1.2cm x 4mm x 7mm wide

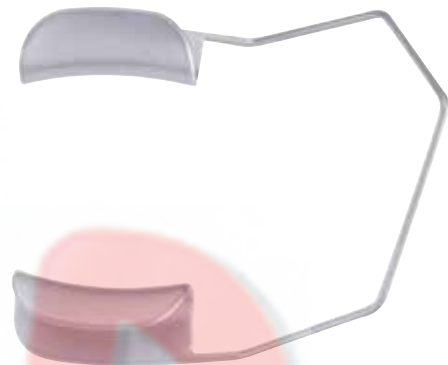

## KRATZ-BARRAQUER WIRE EYE SPECULUM

Wire blades 14mm long x 7mm deep. Adult.

<u>Item Number</u>	<u>Description</u>
MDS0787897	Overall length 1 <sup>3</sup> / <sub>4</sub> " (4.4cm)

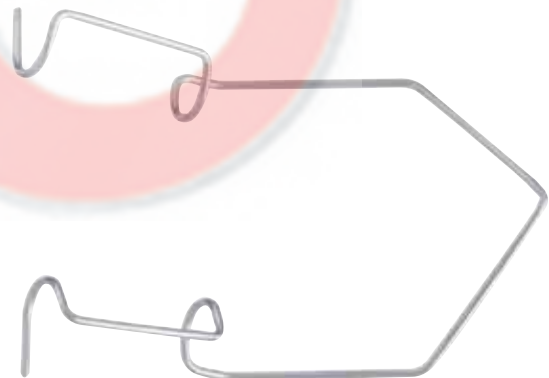

## SAUER EYE SPECULUM

Solid blades 1cm long x 4.5mm deep.

<u>Item Number</u>	<u>Description</u>
MDS0787931	Overall length 1 <sup>1</sup> / <sub>4</sub> " (3.2cm)



## THORNTON WIRE EYE SPECULUM

Wire blades with wings 15mm long x 7mm deep.

<u>Item Number</u>	<u>Description</u>
MDS0787915	Overall length 1 <sup>3</sup> / <sub>4</sub> " (4.4cm)

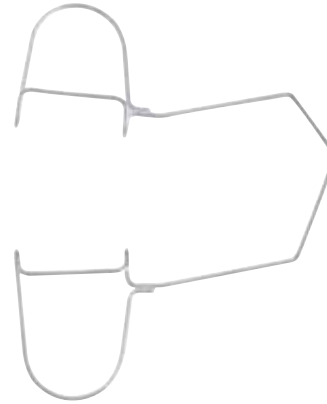

## COOK EYE SPECULUM

Solid blade with lock nut.

<u>Item Number</u>	<u>Description</u>
MDS0787933	Blades 7.5mm long x 5mm deep, overall length 1 <sup>1</sup> / <sub>2</sub> " (3.8cm)



## LANCASTER EYE SPECULUM

Solid blades 15mm long x 7mm deep.

<u>Item Number</u>	<u>Description</u>
MDS0765755	Overall length 3" (7.6cm)



## CASTROVIEJO EYE SPECULUM

Curved arms. Open blades 15mm long x 7.5mm deep.

<u>Item Number</u>	<u>Description</u>
MDS0787967	Overall length 3 <sup>1</sup> / <sub>4</sub> " (8.3cm)





### LIEBERMAN EYE SPECULUM

V-wire with adjustable mechanism.  
Blades 13mm long x 7mm deep.

Item Number	Description
MDS0787957	Overall length 3 1/8" (8cm)



### LIEBERMAN EYE SPECULUM

K-wire with adjustable mechanism.  
Blades 15mm long x 7mm deep.

Item Number	Description
MDS0787953	Overall length 3 1/8" (8cm)

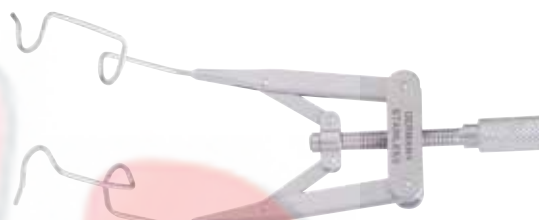

### LIEBERMAN EYE SPECULUM

Angled 45°. Solid blades 15mm long x 7mm wide.

Item Number	Description
MDS0787959	Overall length 3 1/8" (7.8cm)

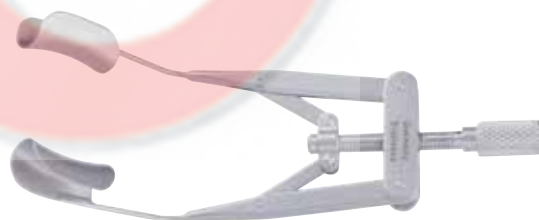

### LIEBERMAN OPEN WIRE EYE SPECULUM

With aspirator. Open wire blades  
15mm long x 7mm deep.

Item Number	Description
MDS0787949	Adult

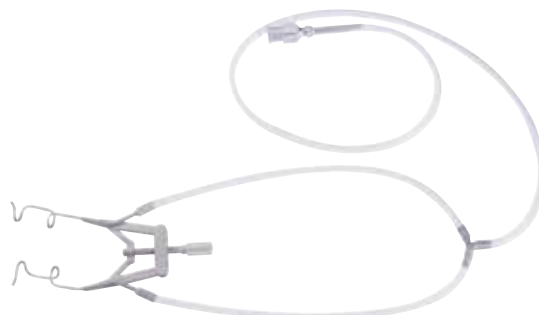

## SCHOTT EYE SPECULUM

Rotatable adjustment mechanism.  
Wire blades 55mm x 11mm.

<u>Item Number</u>	<u>Description</u>
MDS0787993	Overall length 4 $\frac{1}{8}$ " (10.5cm)

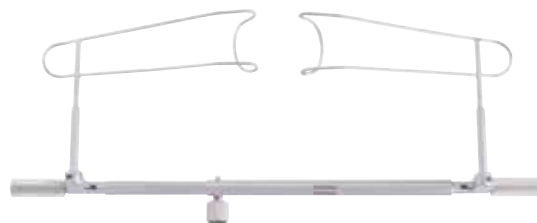

## DESMARRES LID RETRACTORS

Overall length 5 $\frac{1}{2}$ " (14cm).

<u>Item Number</u>	<u>Description</u>
MDS1823108	Extra-small, No. 0, 9mm wide
MDS1823112	Small, No. 1, 12mm wide
MDS1823114	Medium, No. 2, 13mm wide
MDS1823116	Large, No. 3, 16mm wide



## SERREFINE

Finely constructed, for holding sutures out of the field.

<u>Item Number</u>	<u>Description</u>
MDS0795861	Overall length 1 $\frac{3}{8}$ " (3.5cm)



## JAEGER LID PLATE

<u>Item Number</u>	<u>Description</u>
MDS0755399	Overall length 4 $\frac{3}{8}$ " (11cm)



## JAFFE WIRE LID RETRACTOR

Large. Wire blades 14mm long x 7mm deep.

<u>Item Number</u>	<u>Description</u>
MDS0777386	Set of two

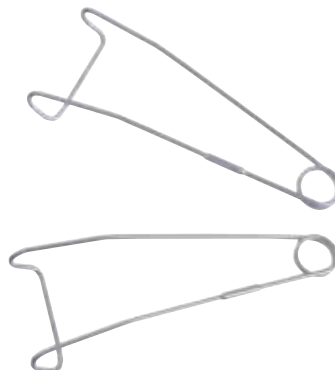

## KNAPP LACRIMAL SAC RETRACTORS

Four prongs. 1cm wide.

<u>Item Number</u>	<u>Description</u>
MDS4237813	Sharp, overall length 5" (12.7cm)



## AGRIKOLA LACRIMAL SAC RETRACTOR

Curved, 3 x 3 semi-sharp prongs.  
Finger grips and screw lock.

<u>Item Number</u>	<u>Description</u>
MDS0787026	Overall length 1 1/2" (3.8cm)



## RAZOR BLADE BREAKER AND HOLDER

With push-pull lock ferrule. Closes to small. Round serrated handle for delicate manipulations. Short model.

<u>Item Number</u>	<u>Description</u>
MDS0713561	Overall length 4 1/4" (10.8cm)



### FOREIGN BODY SPUD

Encased in double-ended handle.  
Overall length 4" (10.2cm).

Item Number	Description
MDS1899054	Curved needle spud 3mm x 5mm and flat spud 2mm x 18mm



### LAFORCE "GOLF CLUB" KNIFE SPUD

Round blade 2mm.

Item Number	Description
MDS0711211	Overall length 4 <sup>3</sup> / <sub>4</sub> " (12.1cm)



### FRANCIS KNIFE SPUD

Blade 1.5mm x 1mm wide, angled 65°.

Item Number	Description
MDS0711226	Overall length 4 <sup>3</sup> / <sub>4</sub> " (12cm)



### MEYHOEFFER CHALAZION CURETTES

Overall length 5" (12.7cm).

Item Number	Description
MDS0792039	Extra-small cup, diameter 1.5mm
MDS0792049	Small cup, diameter 2mm
MDS0792044	Medium cup, diameter 2.5mm
MDS0714271	Large cup, diameter 3.5mm



## NEW ORLEANS LENS LOOP

Long oval, very light. 10mm x 5mm wide loop.

<u>Item Number</u>	<u>Description</u>
MDS0716376	Overall length 5 <sup>3</sup> / <sub>8</sub> " (13.7cm)



## KIRBY LENS LOOP AND MUSCLE HOOK

Double-ended with 8mm x 5mm wide loop and 10mm long muscle hook.

<u>Item Number</u>	<u>Description</u>
MDS0767241	Overall length 5 <sup>7</sup> / <sub>8</sub> " (15cm)



## CASTROVIEJO CYCLODIALYSIS SPATULAS

Double-ended. Overall length 5" (12.7cm).

<u>Item Number</u>	<u>Description</u>
MDS0714077	1cm x 0.25mm wide and 1.5cm x 0.25mm wide
MDS0792856	1cm x 0.5mm wide and 1.5cm x 0.5mm wide
MDS0714079	1cm x 0.75mm wide and 1.5cm x 0.75mm wide

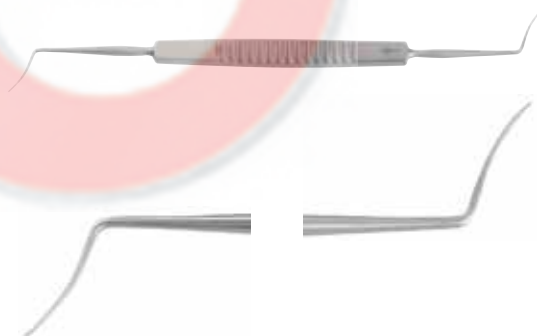

## NAGAHARA NUCLEUS CHOPPERS

1.25mm tip. Blade offset at 60° angle. Round, knurled handle. Overall length 4<sup>3</sup>/<sub>4</sub>" (12cm).

<u>Item Number</u>	<u>Description</u>
MDS0719286	Left
MDS0719291	Right

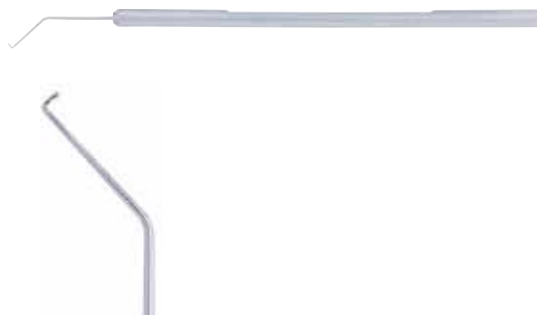

## DRYSDALE NUCLEUS MANIPULATOR

Paddle-shaped tip.

<u>Item Number</u>	<u>Description</u>
MDS0796314	Overall length 4 <sup>3</sup> / <sub>8</sub> " (11cm)

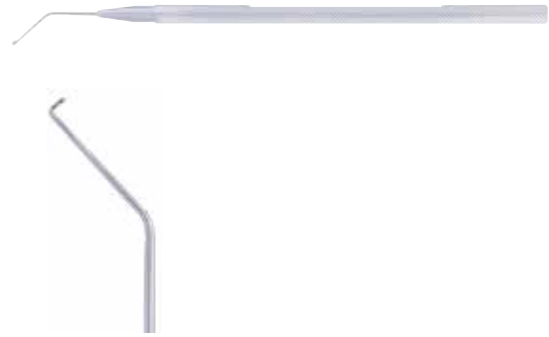

## BECHERT NUCLEUS ROTATOR

Jaw size 1mm wide.

<u>Item Number</u>	<u>Description</u>
MDS0718439	Overall length 4 <sup>1</sup> / <sub>2</sub> " (11.4cm)



## JAFFE-BECHERT LENS NUCLEUS ROTATOR

Blunt forked tip. Angled. 9mm.

<u>Item Number</u>	<u>Description</u>
MDS0718461	Overall length 4 <sup>1</sup> / <sub>2</sub> " (11.5cm)



## STEVENS TENOTOMY HOOK

Blunt tip.

<u>Item Number</u>	<u>Description</u>
MDS0767131	Overall length 4 <sup>3</sup> / <sub>4</sub> " (12.1cm)



## OSHER Y-HOOK

Straight.

<u>Item Number</u>	<u>Description</u>
MDS0766291	Overall length 4 $\frac{1}{2}$ " (11.5cm)



## TYRELL HOOK

2mm wide. Overall length 4 $\frac{3}{4}$ " (12.1cm).

<u>Item Number</u>	<u>Description</u>
MDS0743159	Sharp



## FIXATION HOOKS

Two sharp prongs. Working length 1" (2.5cm).  
Overall length 5" (12.7cm).

<u>Item Number</u>	<u>Description</u>
MDS1821201	Prongs 1.5mm wide
MDS1821202	Prongs 2mm wide

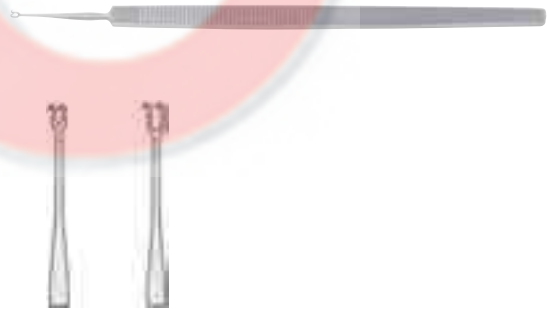

## JAMESON MUSCLE HOOK

Small, bulbous tip with flat sides.  
Overall length 4 $\frac{3}{4}$ " (12cm).

<u>Item Number</u>	<u>Description</u>
MDS0767211	Flat, serrated handle





## VON GRAEFE STRABISMUS HOOKS

<u>Item Number</u>	<u>Description</u>
MDS0767156	Small, 1.3cm, overall length $5\frac{3}{8}$ " (13.7cm)
MDS0745949	Medium, 1.6cm, overall length $5\frac{1}{2}$ " (14cm)
MDS0767166	Large, 1.7cm, overall length $5\frac{5}{8}$ " (14.3cm)



## WIENER HOOK

Sharp.

<u>Item Number</u>	<u>Description</u>
MDS4237213	Overall length 5" (12.7cm)



## GREEN STRABISMUS HOOK

<u>Item Number</u>	<u>Description</u>
MDS0745009	Overall length 5" (12.7cm)



## JAMESON STRABISMUS HOOK

<u>Item Number</u>	<u>Description</u>
MDS0767216	Overall length $5\frac{1}{8}$ " (13cm)



## O'CONNOR SHARP HOOK

<u>Item Number</u>	<u>Description</u>
MDS1822816	Overall length 5½" (14cm)



## GASS RETINAL DETACHMENT HOOK

Tip 13mm. "Graefe-type" hook with 1.5mm oval hole. Flattened tip. Flat handle.

<u>Item Number</u>	<u>Description</u>
MDS0767431	Overall length 5⅞" (15cm)



## HARRIS-SINSKEY MICRO LENS HOOK

Blunt hook. Angled 45°. Flat handle.

<u>Item Number</u>	<u>Description</u>
MDS0766131	Overall length 4½" (11.4cm)



## FENZL MICRO LENS INSERTION HOOK

Angled 45°. Round handle.

<u>Item Number</u>	<u>Description</u>
MDS0766246	Overall length 4" (10.2cm)



## KUGLEN IRIS HOOK AND LENS MANIPULATORS

Push-pull model. Round handle.  
Overall length 4½" (11.5cm).

<u>Item Number</u>	<u>Description</u>
MDS0766216	Angled
MDS0766211	Straight



## SINSKEY MICRO LENS HOOK

Blunt hook. Angled 90°.

<u>Item Number</u>	<u>Description</u>
MDS0766126	Overall length 4 <sup>5</sup> / <sub>8</sub> " (11.7cm)



## SINSKEY II MICRO LENS HOOK

Blunt hook. Flat handle. Angled 90°.

<u>Item Number</u>	<u>Description</u>
MDS0744924	Overall length 4 <sup>5</sup> / <sub>8</sub> " (11.7cm)



## SINSKEY LENS MANIPULATING HOOKS

Tip diameter 0.25mm. Blunt tip. Round handle.  
Overall length 4½" (11.5cm).

<u>Item Number</u>	<u>Description</u>
MDS0766141	Angled
MDS0766136	Straight with guard



## SINSKEY II LENS MANIPULATING HOOKS

Tip diameter 0.2mm. Blunt tip. Round handle.  
Overall length 4½" (11.5cm).

<u>Item Number</u>	<u>Description</u>
MDS0766151	Angled
MDS0766156	Straight with guard



## KUGLEN IRIS HOOK AND LENS MANIPULATORS

Push-pull model. Overall length 4½" (11.4cm).

<u>Item Number</u>	<u>Description</u>
MDS0766186	Angled 45°
MDS0766196	Cloverleaf tip
MDS0766181	Straight



## CLAYMAN-JAFFE LENS MANIPULATING HOOK

Angled. 0.2mm blunt hook.

<u>Item Number</u>	<u>Description</u>
MDS0766121	Overall length 4¾" (12cm)

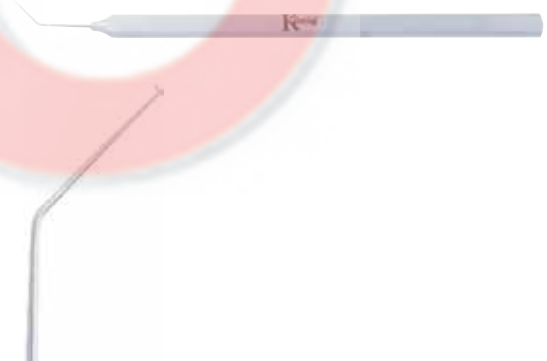

## LESTER IOL MANIPULATORS

For lenses without holes.

<u>Item Number</u>	<u>Description</u>
MDS7518876	Curved, overall length 4⅞" (12.5cm)
MDS0718871	Straight, with guard, overall length 4¾" (12cm)

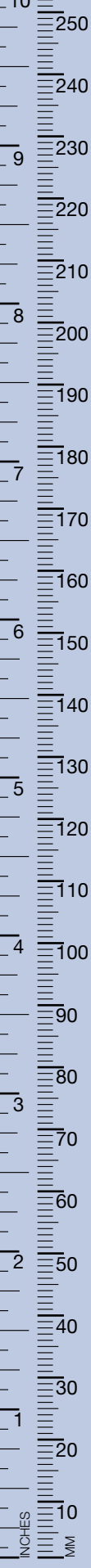

## KOCH STOP AND CHOP MANIPULATOR

Angled shaft with 1.5mm tip. Round, knurled handle.

<u>Item Number</u>	<u>Description</u>
MDS0719311	Overall length 4 <sup>3</sup> / <sub>8</sub> " (11.2cm)

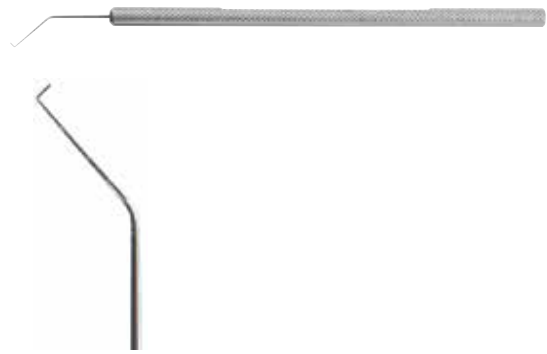

## MCPHERSON-VANNAS MICRO IRIS SCISSORS

Curved blades. Sharp tips.

<u>Item Number</u>	<u>Description</u>
MDS0707764	Overall length 3" (7.5cm)



## MCCLURE IRIS SCISSORS

Angled.

<u>Item Number</u>	<u>Description</u>
MDS0729729	Overall length 4 <sup>1</sup> / <sub>2</sub> " (11.4cm)



## MICRO IRIS SCISSORS

Fine. Sharp blades, 1cm from mid-screw.  
Overall length 4<sup>3</sup>/<sub>8</sub>" (11.1cm).

<u>Item Number</u>	<u>Description</u>
MDS0707594	Curved
MDS0729836	Straight



## IRIS SCISSORS

<u>Item Number</u>	<u>Description</u>
MDS0729726	Curved, overall length 4½" (11.4cm)
MDS0729721	Straight, overall length 4½" (11.4cm)



## IRIS SCISSORS

Ribbon-style handles. Blades 3cm from mid-screw.  
Overall length 4" (10.2cm).

<u>Item Number</u>	<u>Description</u>
MDS0805210	Straight
MDS0805310	Heavy, curved

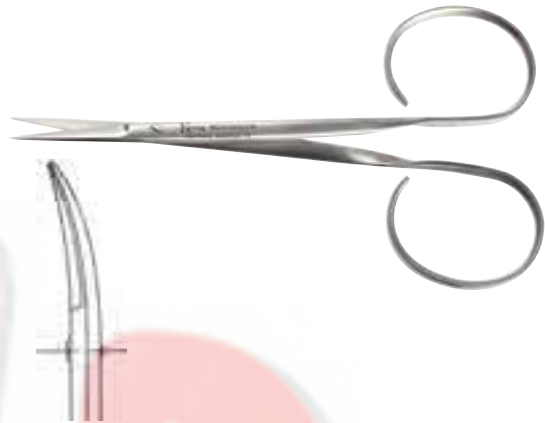

## IRIS SCISSORS

Overall length 3½" (8.9cm).

<u>Item Number</u>	<u>Description</u>
MDS0834109	Curved
MDS0834009	Straight

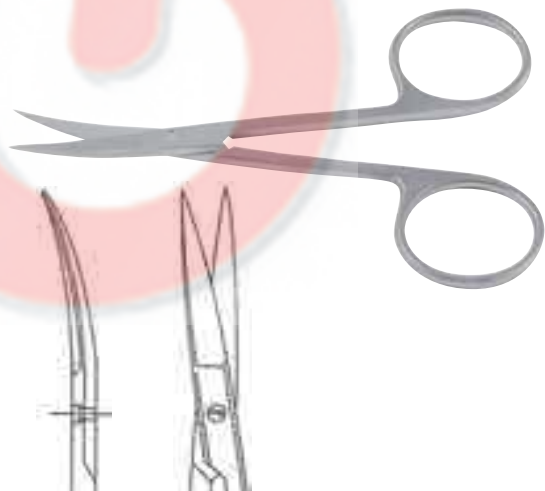

## WILMER IRIS SCISSORS

Angled.

<u>Item Number</u>	<u>Description</u>
MDS0838602	Overall length 3½" (8.9cm)



## IRIS SCISSORS

Angled.

<u>Item Number</u>	<u>Description</u>
MDS0863511	Overall length 4 1/2" (11.4cm)



## KNAPP IRIS SCISSORS

Straight. Blades 3cm from mid-screw.  
Overall length 4" (10.2cm).

<u>Item Number</u>	<u>Description</u>
MDS0839011	Sharp/sharp
MDS0837602	Sharp/blunt
MDS0837601	Blunt/blunt



MDS0837602



MDS0837601

## KNAPP IRIS SCISSORS

Light pattern. Blades 3.5cm from mid-screw.  
Overall length 4" (10.2cm).

<u>Item Number</u>	<u>Description</u>
MDS0728981	Straight
MDS0728986	Curved

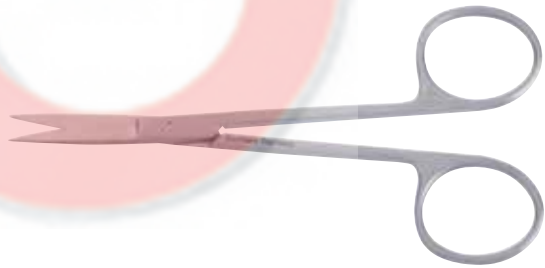

## KNAPP IRIS SCISSORS

Curved. Blades 3cm from mid-screw.  
Overall length 4" (10cm).

<u>Item Number</u>	<u>Description</u>
MDS0838510	Sharp/sharp
MDS0837702	Sharp/blunt
MDS0837701	Blunt/blunt



MDS0838510



MDS0837701



MDS0837702



## SUPER CUT IRIS SCISSORS

Black handles. Overall length 4 1/2" (11.4cm).

<u>Item Number</u>	<u>Description</u>
--------------------	--------------------

MDS0734110	Curved
MDS0734312	Straight



## VANNAS IRIDOCAPSULOTOMY SCISSORS

90° blades.

<u>Item Number</u>	<u>Description</u>
--------------------	--------------------

MDS0729976	Overall length 3 3/8" (8.5cm)
------------	-------------------------------



## VANNAS IRIDOCAPSULOTOMY SCISSORS

Small blades. Overall length 3 3/8" (8.5cm).

<u>Item Number</u>	<u>Description</u>
--------------------	--------------------

MDS0729971	Angled, blades 6mm from mid-screw
MDS0729961	Straight, blades 8.5mm from mid-screw
MDS0729966	Curved, blades 8.5mm from mid-screw



## GILLS-VANNAS CAPSULOTOMY SCISSORS

Thin long blades with sharp tips.

<u>Item Number</u>	<u>Description</u>
--------------------	--------------------

MDS0729901	Straight
MDS0729906	Curved
MDS0729011	Angled forward



## STERN-GILLS SCISSORS

Thin blades with sharp tips, length 10mm.  
Angled forward.

<u>Item Number</u>	<u>Description</u>
MDS0729041	Overall length 4 <sup>3</sup> / <sub>4</sub> " (12cm)



## CASTROVIEJO KERATOPLASTY SCISSORS

Angled, blunt blades. Lower blade length 16mm.  
Upper blade length 15mm. Serrated handle.

<u>Item Number</u>	<u>Description</u>
MDS0831345	Overall length 4 <sup>3</sup> / <sub>8</sub> " (11cm)



## CASTROVIEJO CORNEAL SCISSORS

Angled. Blunt. Blade length 1.5cm from mid-screw.  
Mirror finish.

<u>Item Number</u>	<u>Description</u>
MDS0707419	Overall length 3 <sup>1</sup> / <sub>2</sub> " (9cm)



## CASTROVIEJO CORNEAL SCISSORS

Curved. Blunt. Blades 1.6cm from mid-screw.  
Mirror finish.

<u>Item Number</u>	<u>Description</u>
MDS0729616	Overall length 4 <sup>1</sup> / <sub>2</sub> " (11.4cm)



## CASTROVIEJO MICRO CORNEAL SCISSORS

Curved.

<u>Item Number</u>	<u>Description</u>
MDS0729501	Overall length 4" (10.2cm)



## MCGUIRE CORNEAL SCISSORS

Overall length 4" (10.2cm).

<u>Item Number</u>	<u>Description</u>
MDS0728926	Right

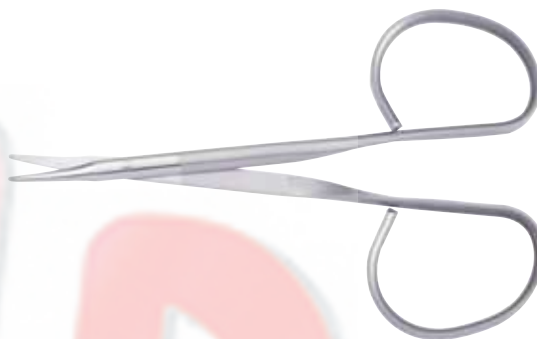

## KNAPP STRABISMUS SCISSORS

Blunt/Blunt. Overall length 4" (10.2cm).

<u>Item Number</u>	<u>Description</u>
MDS0729136	Straight

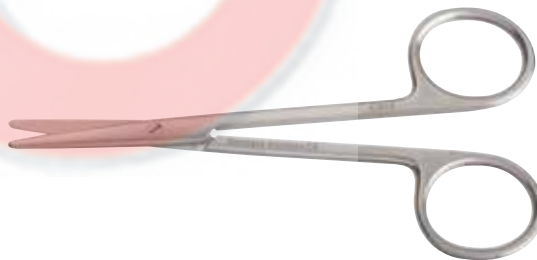

## KNAPP STRABISMUS SCISSORS

Slightly curved blades. Blunt/Blunt.

<u>Item Number</u>	<u>Description</u>
MDS0729141	Overall length 4" (10.2cm)



## STRABISMUS SCISSORS

Round blades. Ribbon-style handles.  
Overall length 4<sup>1</sup>/<sub>4</sub>" (10.8cm).

<u>Item Number</u>	<u>Description</u>
MDS0796719	Straight
MDS0728041	Curved



## WESTCOTT TENOTOMY SCISSORS

Slightly curved blades. Wide handle.  
Overall length 4<sup>1</sup>/<sub>8</sub>" (10.5cm).

<u>Item Number</u>	<u>Description</u>
MDS0729921	Left
MDS0910411	Right



## STEVENS TENOTOMY SCISSORS

Blades 3.2cm from mid-screw. Mirror finish.

<u>Item Number</u>	<u>Description</u>
MDS0836210	Straight, overall length 4" (10.2cm)
MDS0836211	Straight, overall length 4 <sup>1</sup> / <sub>2</sub> " (11.4cm)
MDS0836310	Curved, overall length 4" (10.2cm)
MDS0836311	Curved, overall length 4 <sup>1</sup> / <sub>2</sub> " (11.4cm)

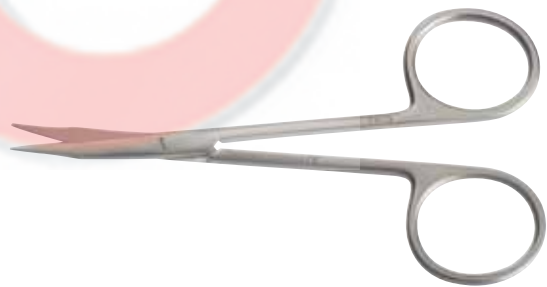

## MCPHERSON MICRO TENOTOMY AND CONJUNCTIVAL SCISSORS

Curved. Blunt tips.

<u>Item Number</u>	<u>Description</u>
MDS0729891	Overall length 3 <sup>1</sup> / <sub>4</sub> " (8.3cm)



## STEVENS TENOTOMY SCISSORS

Ribbon-style ring handle. Curved blades, 18mm from mid-screw.

<u>Item Number</u>	<u>Description</u>
MDS0729211	Overall length 4" (10.2cm)



## WESCOTT TENOTOMY SCISSORS

Blade length 16mm from mid-screw. Blunt tips. Wide, serrated handle. Mirror finish. Overall length 5 1/4" (13.2cm).

<u>Item Number</u>	<u>Description</u>
MDS0729896	Curved tips



## WESTCOTT TENOTOMY SCISSORS

Curved right. Blunt tips. Mirror finish.

<u>Item Number</u>	<u>Description</u>
MDS0729016	Blades 21mm from mid-screw, serrated upper blade, overall length 4 7/8" (12.3cm)
MDS0731929	Blades 23mm from mid-screw, overall length 5 5/8" (14.2cm)



## STEVENS TENOTOMY SCISSORS

Blade length 19mm from mid-screw. Straight blades with blunt tips. Ring handles.

<u>Item Number</u>	<u>Description</u>
MDS0729196	Overall length 4" (10cm)



## MCPHERSON MICRO UTILITY OR SUTURE SCISSORS

Sharp, pointed tenotomy-type tips. Curved blades.

<u>Item Number</u>	<u>Description</u>
MDS0729811	Overall length 3 <sup>3</sup> / <sub>4</sub> " (9.5cm)



## WESTCOTT-TYPE UTILITY SCISSORS

Flat, serrated handles.

<u>Item Number</u>	<u>Description</u>
MDS0729951	Overall length 5" (12.7cm)



## SPENCER STITCH SCISSORS

<u>Item Number</u>	<u>Description</u>
MDS0880209	Overall length 3 <sup>1</sup> / <sub>2</sub> " (8.9cm)

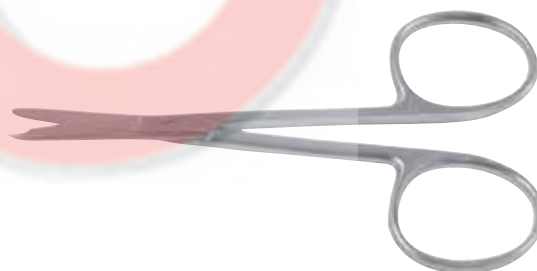

## WESTCOTT-TYPE STITCH SCISSORS

Very sharp pointed tips for removal of sutures. Blades 22mm from mid-screw.

<u>Item Number</u>	<u>Description</u>
MDS0729821	Overall length 4 <sup>3</sup> / <sub>8</sub> " (11.1cm)



## WESTCOTT-TYPE STITCH SCISSORS

Blade length 21mm from mid-screw. Straight, sharp, pointed tips. Flat, serrated handles.

<u>Item Number</u>	<u>Description</u>
MDS0729826	Overall length 5½" (14cm)



## STITCH SCISSORS

Curved, short blades.

<u>Item Number</u>	<u>Description</u>
MDS0836110	Overall length 4⅞" (10.5cm)



## STITCH SCISSORS

Curved blades.

<u>Item Number</u>	<u>Description</u>
MDS0729111	Overall length 3⅞" (9.8cm)

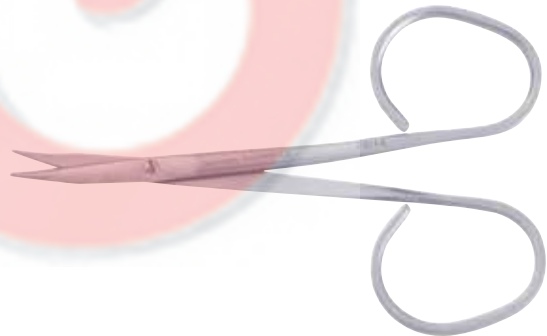

## MCPHERSON MICROSURGERY EYE NEEDLE HOLDERS

Very fine. Narrow jaws.  
Overall length 4⅞" (10.5cm).

<u>Item Number</u>	<u>Description</u>
MDS0750296	Straight, with lock
MDS0750201	Straight, without lock
MDS0750206	Curved, with lock
MDS0750311	Curved, without lock





## BARRAQUER NEEDLE HOLDER

Fine, curved jaws.

<u>Item Number</u>	<u>Description</u>
MDS0759031	Round, knurled handle, with lock, jaw length 9mm, overall length 5 <sup>1</sup> / <sub>4</sub> " (13.2cm)



## BARRAQUER EYE NEEDLE HOLDERS

Curved, smooth jaws, length 10mm.  
Overall length 5<sup>1</sup>/<sub>4</sub>" (13.3cm).

<u>Item Number</u>	<u>Description</u>
MDS2466314	With lock
MDS0759906	Without lock
MDS3459896	Fine, with lock



## TITANIUM BARRAQUER BABY NEEDLE HOLDERS

Fine jaws, length 9mm. Curved. Round, knurled handle.  
Overall length 4<sup>1</sup>/<sub>4</sub>" (10.8cm).

<u>Item Number</u>	<u>Description</u>
MDS3459771	With lock
MDS3459773	Without lock

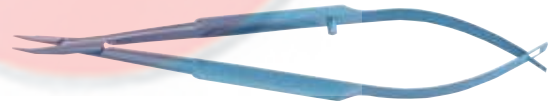

## MICRO-SURGICAL NEEDLE HOLDERS

Fine jaws, length 8mm. Round handle.  
Overall length 5<sup>1</sup>/<sub>4</sub>" (13.3cm).

<u>Item Number</u>	<u>Description</u>
MDS0759991	Straight, with lock
MDS3850676	Curved, without lock
MDS0759996	Straight, without lock



## CASTROVIEJO NEEDLE HOLDER

Fine. Smooth jaws for very fine needles and sutures, length 9mm. With lock.

<u>Item Number</u>	<u>Description</u>
MDS0750376	Straight



## CASTROVIEJO EYE NEEDLE HOLDERS

Straight, smooth jaws, length 9mm. Long shanks and wide handles. Overall length 5 1/2" (14cm).

<u>Item Number</u>	<u>Description</u>
MDS2482214	With lock
MDS2481814	Without lock



## CASTROVIEJO EYE NEEDLE HOLDER

Straight, smooth jaws, length 9mm. Short shanks and wide handles. Overall length 5 1/8" (13cm).

<u>Item Number</u>	<u>Description</u>
MDS0750341	With lock



## CASTROVIEJO NEEDLE HOLDERS

Curved jaws, length 10mm. Flat, serrated handle. Overall length 5 1/2" (14cm).

<u>Item Number</u>	<u>Description</u>
MDS0750391	Without lock
MDS0750386	With lock



## CASTROVIEJO NEEDLE HOLDERS

Jaw length 12mm. Standard jaws. Flat, serrated handle with lock. Overall length 5½" (14cm).

<u>Item Number</u>	<u>Description</u>
MDS0738294	Curved
MDS0750411	Straight



## CASTROVIEJO NEEDLE HOLDER

16mm straight, heavy jaws. Flat, serrated handle with lock.

<u>Item Number</u>	<u>Description</u>
MDS0750441	Overall length 5¾" (14.5cm)



## KALT EYE NEEDLE HOLDERS

Straight, mild spring action with thumb rest and catch. Overall length 5¼" (13.3cm).

<u>Item Number</u>	<u>Description</u>
MDS0750486	Straight jaws
MDS0750491	Very fine, fine-pointed straight jaws



## HALSEY NEEDLE HOLDER

Smooth jaws.

<u>Item Number</u>	<u>Description</u>
MDS2413013	Overall length 5" (12.7cm)



## EYE DRESSING FORCEPS

Serrated. Overall length 4" (10.2cm).

<u>Item Number</u>	<u>Description</u>
--------------------	--------------------

MDS0725989	Fine
------------	------



## DRESSING FORCEPS

Fully-curved, serrated.

<u>Item Number</u>	<u>Description</u>
--------------------	--------------------

MDS0747106	Overall length 4" (10.2cm)
------------	----------------------------



## BISHOP-HARMON DRESSING FORCEPS

Cross-serrated tips, without teeth.

<u>Item Number</u>	<u>Description</u>
--------------------	--------------------

MDS0725964	Overall length 3 <sup>3</sup> / <sub>8</sub> " (8.6cm)
------------	--



## KELMAN-MCPHERSON FORCEPS

Very fine. Smooth. Jaw length 7.5mm.  
Angled. Flat, fenestrated handle.

<u>Item Number</u>	<u>Description</u>
--------------------	--------------------

MDS0748766	Overall length 4" (10.2cm)
------------	----------------------------



## LISTER CONJUNCTIVAL FORCEPS

Fine teeth. Overall length 3 1/2" (8.9cm).

<u>Item Number</u>	<u>Description</u>
MDS0747266	2 x 3 teeth
MDS0747261	1 x 2 teeth



## THORPE CONJUNCTIVAL FIXATION FORCEPS

2 x 3 teeth. Overall length 3 3/4" (9.5cm).

<u>Item Number</u>	<u>Description</u>
MDS0747272	Shallow 0.6mm teeth at 90°
MDS0747271	Very fine, 12mm teeth at 45°

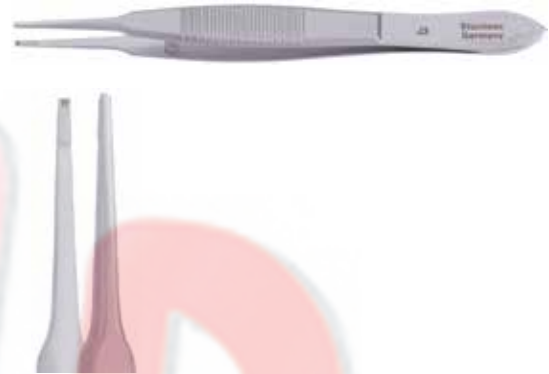

## GREEN FIXATION FORCEPS

T-shaped jaws, 5mm wide.

<u>Item Number</u>	<u>Description</u>
MDS0747446	Overall length 4" (10.2cm)



## STEVENS FIXATION FORCEPS

Plain. 1 x 2 teeth.

<u>Item Number</u>	<u>Description</u>
MDS4284010	Overall length 4" (10.2cm)



## ELSCHNIG-O'BRIEN FIXATION FORCEPS

Plain. Fine. 1 x 2 teeth.

<u>Item Number</u>	<u>Description</u>
MDS0747326	Overall length 3 <sup>7</sup> / <sub>8</sub> " (9.8cm)



## VON GRAEFE FIXATION FORCEPS

Without lock. Jaws 5mm.

<u>Item Number</u>	<u>Description</u>
MDS0747436	Overall length 4 <sup>1</sup> / <sub>4</sub> " (10.8cm)



## STERN-CASTROVIEJO FIXATION FORCEPS

Tips 0.5mm, 1 x 2 teeth. Curved.  
Serrated handle with lock.

<u>Item Number</u>	<u>Description</u>
MDS0747291	Overall length 4 <sup>1</sup> / <sub>4</sub> " (10.8cm)

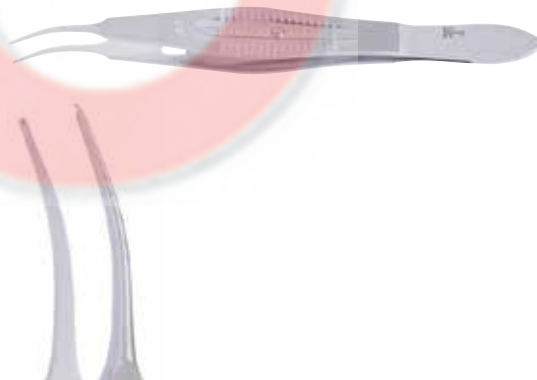

## CASTROVIEJO FIXATION FORCEPS

Tips 0.3mm, 1 x 2 teeth. Straight. Without platform.  
Wide, serrated handle.

<u>Item Number</u>	<u>Description</u>
MDS4306609	Overall length 4 <sup>1</sup> / <sub>4</sub> " (10.8cm)



## SAUER SUTURE FORCEPS

<u>Item Number</u>	<u>Description</u>
MDS0748521	Overall length 3 $\frac{1}{2}$ " (8.9cm)



## BONN SUTURING FORCEPS

Long. With tying platform. 0.12mm teeth.

<u>Item Number</u>	<u>Description</u>
MDS0748736	Overall length 3 $\frac{5}{8}$ " (9.2cm)

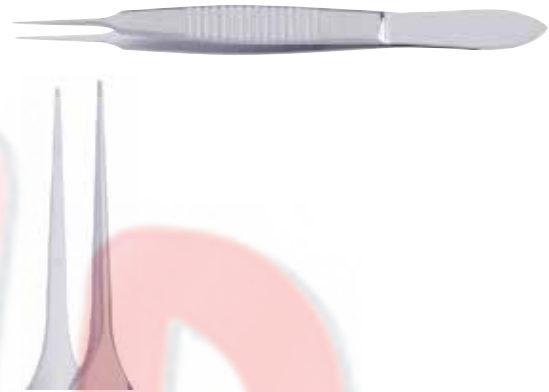

## PAUFIQUE SUTURE FORCEPS

1 x 2 teeth. Straight. 6mm tying platform. Wide, serrated handle.

<u>Item Number</u>	<u>Description</u>
MDS0748526	Overall length 3 $\frac{3}{8}$ " (8.7cm)



## MANHATTAN SUTURE FORCEPS

1 x 2 teeth. Straight shaft with teeth set at oblique angle to shafts. Wide, serrated handle.

<u>Item Number</u>	<u>Description</u>
MDS0748531	Overall length 3 $\frac{3}{8}$ " (8.7cm)





## MCCULLOUGH SUTURE FORCEPS

1 x 2 teeth. Straight. Serrations behind teeth.  
Serrated handle.

<u>Item Number</u>	<u>Description</u>
MDS0748516	Overall length $3\frac{5}{8}$ " (9.2cm)

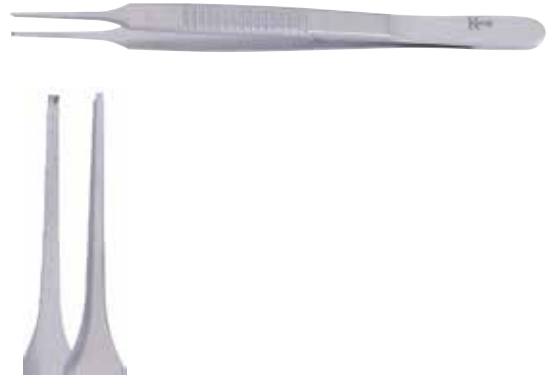

## CASTROVIEJO CORNEOSCLERAL SUTURE FORCEPS

1 x 2 teeth, 6mm tying platform.  
Overall length  $4\frac{1}{8}$ " (10.5cm).

<u>Item Number</u>	<u>Description</u>
MDS4315003	Fine 0.3mm teeth
MDS4315005	Fine 0.5mm teeth
MDS0793025	Fine 0.9mm teeth
MDS4315015	1.5mm teeth



## CASTROVIEJO SUTURE FORCEPS

1 x 2 teeth.

<u>Item Number</u>	<u>Description</u>
MDS4315001	Tips 0.12mm teeth, standard handle, overall length 4" (10.1cm)



## STERN-CASTROVIEJO SUTURE FORCEPS

Tips 0.5mm teeth. 6mm tying platform. Straight.  
Wide, serrated handle with lock.

<u>Item Number</u>	<u>Description</u>
MDS0726399	Overall length $4\frac{1}{4}$ " (10.8cm)



### JAFFE-CASTROVIEJO SUTURE FORCEPS

1 x 2 teeth. Straight. 5mm tying platform.  
Overall length 4 1/4" (10.8cm).

Item Number	Description
MDS0748451	0.12mm teeth
MDS0748456	0.3mm teeth
MDS0748461	0.5mm teeth



### TENNANT TYING FORCEPS

6mm tying platform. Overall length 4" (10.2cm).

Item Number	Description
MDS0748866	Straight
MDS0748871	Curved

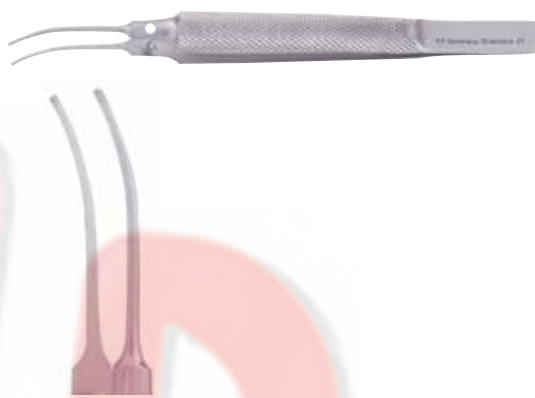

### KELMAN-MCPHERSON MICRO TYING AND TISSUE FORCEPS

Item Number	Description
MDS0748761	Angled tips, 8mm, tying platform, overall length 3 1/2" (8.9cm)
MDS0748396	Angled tips, 8mm, 1 x 2 fine teeth, tying platform, overall length 3 1/2" (8.9cm)
MDS0749278	Straight tips, overall length 3 5/8" (9.2cm)



### MCPHERSON TYING FORCEPS

Jaw length 5mm. Smooth. 4mm tying platform.  
Flat handle. Overall length 4" (10.2cm).

Item Number	Description
MDS0726539	Straight
MDS0748756	Curved



## SHEETS-MCPHERSON TYING FORCEPS

Tip width 1mm, serrated. Angled 45°.  
10.5mm tying platform. Serrated handle.

<u>Item Number</u>	<u>Description</u>
MDS0748771	Overall length 3 <sup>1</sup> / <sub>4</sub> " (8.2cm)



## TITANIUM KELMAN-MCPHERSON TYING FORCEPS

7mm tying platform. Flat, serrated handle.  
Overall length 3<sup>3</sup>/<sub>8</sub>" (8.6cm).

<u>Item Number</u>	<u>Description</u>
MDS3448398	Straight shafts
MDS3448397	Angled shafts

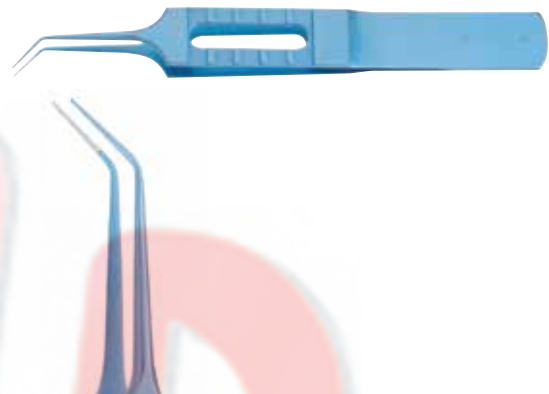

## SUTURE AND TYING FORCEPS

Fine tying platform, with heavy shaft and handle.

<u>Item Number</u>	<u>Description</u>
MDS0748791	Overall length 4 <sup>1</sup> / <sub>8</sub> " (10.5cm)

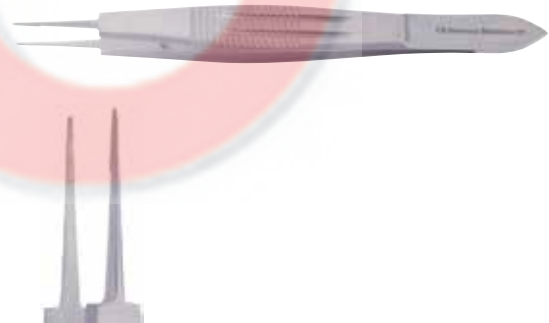

## O'GAWA TYING FORCEPS

1mm tip. 5mm tying platform.  
Overall length 4<sup>3</sup>/<sub>4</sub>" (12.1cm).

<u>Item Number</u>	<u>Description</u>
MDS0748891	Straight
MDS0748896	Curved

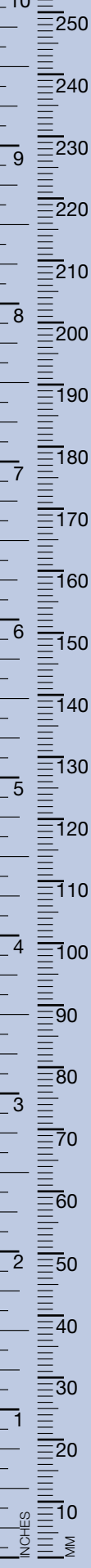

**MCPHERSON MICRO CORNEAL FORCEPS**

Very fine, 1 x 2 teeth.  
Overall length 3<sup>1</sup>/<sub>4</sub>" (8.3cm).

<b>Item Number</b>	<b>Description</b>
MDS0748386	Straight jaws

**CASTROVIEJO CORNEAL SUTURING FORCEPS**

Extra-fine teeth, with tying platform.  
Straight wide handle. Overall length 4<sup>1</sup>/<sub>8</sub>" (10.5cm).

<b>Item Number</b>	<b>Description</b>
MDS4319112	0.12mm teeth
MDS4319113	0.3mm teeth
MDS4319114	0.5mm teeth
MDS4319115	1.5mm teeth

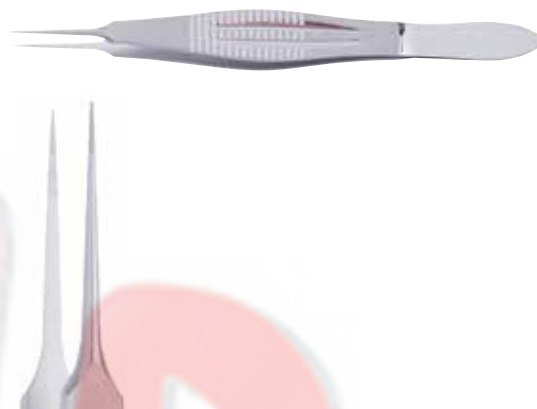
**CASTROVIEJO-COLIBRI-TYPE CORNEAL FORCEPS**

Tips 0.12mm.

<b>Item Number</b>	<b>Description</b>
MDS0746019	Overall length 4 <sup>1</sup> / <sub>8</sub> " (10.5cm)

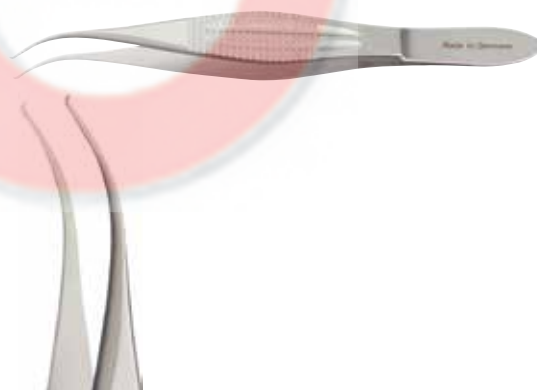
**COLIBRI CORNEAL FORCEPS**

Angled 45°. 1 x 2 teeth. Overall length 3" (7.6cm).

<b>Item Number</b>	<b>Description</b>
MDS0746966	Teeth 0.12mm, with tying platform
MDS0746981	Teeth 0.5mm, with tying platform



## BONN MODEL PERIPHERAL IRIDECTOMY FORCEPS

1 x 2 teeth.

<u>Item Number</u>	<u>Description</u>
MDS0748366	Overall length 2 <sup>7</sup> / <sub>8</sub> " (7.3cm)



## VON GRAEFE IRIS FORCEPS

1 x 2 teeth. Overall length 2<sup>7</sup>/<sub>8</sub>" (7.3cm).

<u>Item Number</u>	<u>Description</u>
MDS0747646	Straight
MDS0757651	Curved



## IRIS FORCEPS

Straight jaws, 1 x 2 teeth. Overall length 3<sup>7</sup>/<sub>8</sub>" (9.8cm).

<u>Item Number</u>	<u>Description</u>
MDS0726454	Light pattern
MDS0726469	Heavy pattern



## IRIS FORCEPS

Curved. 1 x 2 teeth.

<u>Item Number</u>	<u>Description</u>
MDS0726464	Overall length 3 <sup>7</sup> / <sub>8</sub> " (9.8cm)



## MCPHERSON MICRO IRIS AND SUTURE FORCEPS

Smooth tips. Overall length 3<sup>1</sup>/<sub>4</sub>" (8.3cm).

<u>Item Number</u>	<u>Description</u>
MDS0748741	Straight jaws
MDS0726524	Angled jaws



## BISHOP-HARMON IRIS FORCEPS

Straight. 1 x 2 teeth. Overall length 3<sup>3</sup>/<sub>8</sub>" (8.6cm).

<u>Item Number</u>	<u>Description</u>
MDS4294205	Fine
MDS4294208	Standard

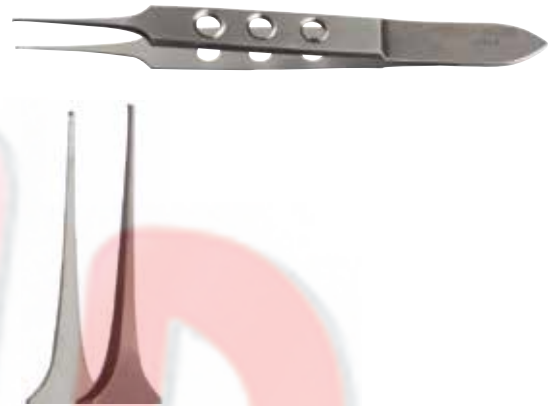

## UTRATA CAPSULORHEXIS FORCEPS

12mm angled shafts. Fine angled tips.

<u>Item Number</u>	<u>Description</u>
MDS0724244	Overall length 3 <sup>1</sup> / <sub>8</sub> " (8cm)

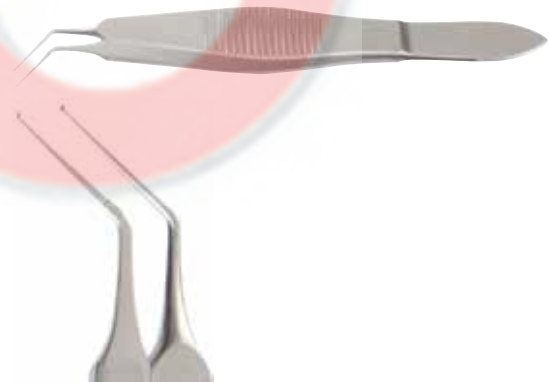

## UTRATA CAPSULORHEXIS FORCEPS

Very fine grasping tips. 11mm long shanks. Flat handle.

<u>Item Number</u>	<u>Description</u>
MDS0793242	Overall length 4" (10.2cm)



## UTRATA FORCEPS

Very fine grasping tips. 11mm long shanks with guide pin.  
Round handle.

<u>Item Number</u>	<u>Description</u>
MDS0746496	Overall length 4 <sup>3</sup> / <sub>8</sub> " (11.2cm)



## TITANIUM UTRATA CAPSULORHEXIS FORCEPS

Jaw length 11mm. Very fine grasping tips.

<u>Item Number</u>	<u>Description</u>
MDS3446483	Short handle, overall length 3 <sup>1</sup> / <sub>4</sub> " (8.3cm)
MDS3446486	Long handle, overall length 4" (10.2cm)
MDS3446496	Round handle, overall length 4 <sup>1</sup> / <sub>4</sub> " (10.8cm)

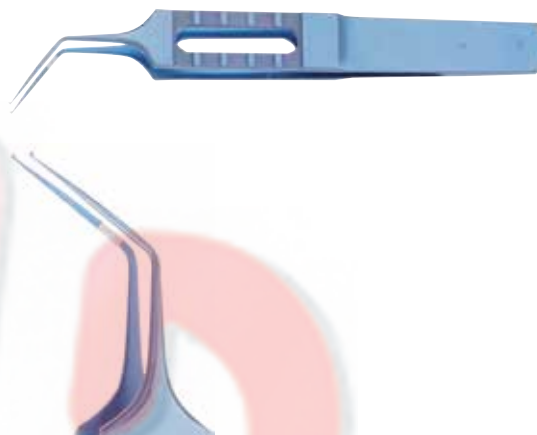

## LEHNER-UTRATA CAPSULORHEXIS FORCEPS

Fine angled tips with gently curved shaft. Round handle.

<u>Item Number</u>	<u>Description</u>
MDS0746401	Overall length 4" (10.2cm)



## CASTROVIEJO CAPSULE FORCEPS

Cross-action, with wide grip handle.  
Cup jaw, 2mm x 3mm.

<u>Item Number</u>	<u>Description</u>
MDS0746391	Overall length 4 <sup>1</sup> / <sub>8</sub> " (10.5cm)





## BAIRD CHALAZION FORCEPS

Very fine ring, inside dimensions 8mm x 10mm.

<u>Item Number</u>	<u>Description</u>
MDS0756471	Overall length 3 <sup>3</sup> / <sub>4</sub> " (9.5cm)



## DESMARRES CHALAZION FORCEPS

Oval solid lower plate, 2.5cm wide.

<u>Item Number</u>	<u>Description</u>
MDS0746636	Overall length 3 <sup>1</sup> / <sub>2</sub> " (8.9cm)



## BERKE PTOSIS FORCEPS

Serrated, longitudinal. Overall length 4<sup>3</sup>/<sub>8</sub>" (11.1cm).

<u>Item Number</u>	<u>Description</u>
MDS0748311	Blades 20mm wide
MDS0748316	Blades 27mm wide



## JAMESON MUSCLE FORCEPS

Jaw 2mm x 13mm. Overall length 4" (10.2cm).

<u>Item Number</u>	<u>Description</u>
MDS0748286	Angled right
MDS0748291	Angled left



## MCPHERSON MICRO BIPOLAR FORCEPS

Tips 0.2mm. Overall length 3½" (8.9cm).

<u>Item Number</u>	<u>Description</u>
MDS1932511	Straight
MDS8010306	Angled



## JEWELER-TYPE BIPOLAR FORCEPS

Straight, pointed, platform tips.

<u>Item Number</u>	<u>Description</u>
MDS8010329	Overall length 4½" (11.5cm)



## COAPTATION BIPOLAR FORCEPS

<u>Item Number</u>	<u>Description</u>
MDS8010989	Working length 4" (10.2cm)



## MCPHERSON BIPOLAR JEWELERS FORCEPS

Angled. Blunt tips, 0.6mm. Not insulated.

<u>Item Number</u>	<u>Description</u>
MDS8010309	Overall length 4¼" (11cm)



## MCCULLOUGH UTILITY FORCEPS

Smooth jaws.

<u>Item Number</u>	<u>Description</u>
MDS0748966	Overall length 4" (10.2cm)



## BONACCOLTO UTILITY AND PICK-UP FORCEPS

Tips have fine cross-serrations.  
Small, 1.2mm wide at tips.

<u>Item Number</u>	<u>Description</u>
MDS0748976	Overall length 3 <sup>7</sup> / <sub>8</sub> " (9.8cm)



## ALABAMA UNIVERSITY UTILITY FORCEPS

Jaws have deep longitudinal groove and fitted platform.

<u>Item Number</u>	<u>Description</u>
MDS0748961	Overall length 3 <sup>5</sup> / <sub>8</sub> " (9.2cm)



## BONACCOLTO UTILITY FORCEPS

Straight 1.7mm wide, 17mm large platform.  
Serrated jaws. Cross-serrated tips. Serrated handle.

<u>Item Number</u>	<u>Description</u>
MDS0748981	Overall length 4 <sup>1</sup> / <sub>4</sub> " (10.9cm)



## WATZKE SLEEVE SPREADING FORCEPS

Jaw length 15mm. 10mm tips, serrated. Angled 30°.  
Serrated cross-action handle.

<u>Item Number</u>	<u>Description</u>
MDS0748231	Overall length 5 <sup>5</sup> / <sub>8</sub> " (14.4cm)



## SCLERAL PLUG FORCEPS

Jaw length 10mm. Cross-action. Serrated handle.

<u>Item Number</u>	<u>Description</u>
MDS0248236	Overall length 4 <sup>1</sup> / <sub>8</sub> " (10.4cm)



## KELLY DECEMET MEMBRANE PUNCH

1mm diameter tip with guard. Overall length 5<sup>1</sup>/<sub>8</sub>" (13cm).

<u>Item Number</u>	<u>Description</u>
MDS0713821	Serrated squeeze handle



## SCHEPENS ORBITAL RETRACTOR

Overall length 5<sup>7</sup>/<sub>8</sub>" (15cm).

<u>Item Number</u>	<u>Description</u>
MDS0777711	Forked



## JENSEN CAPSULE POLISHERS

Carbide tip.

<u>Item Number</u>	<u>Description</u>
--------------------	--------------------

MDS0797746	25GA
------------	------



## JENSEN CAPSULE SCRAPER POLISHERS

Gently curved with olive tip. Front opening.

<u>Item Number</u>	<u>Description</u>
--------------------	--------------------

MDS0797723	23GA
------------	------



## TROUTMAN ALPHA-CHYMOTRYPSIN CANNULA

Fine tip.

<u>Item Number</u>	<u>Description</u>
--------------------	--------------------

MDS0797793	25GA
------------	------



## RANDOLPH CYCLODIALYSIS FRONT CANNULA

<u>Item Number</u>	<u>Description</u>
--------------------	--------------------

MDS0797653	Curved spatula tip
------------	--------------------



## BOWMAN LACRIMAL PROBES

Double-ended. Straight tip. Silver.  
Overall length 5½" (14cm).

<u>Item Number</u>	<u>Description</u>
MDS0796311	Sizes 0000-000
MDS0796316	Sizes 00-0
MDS0796321	Sizes 1-2
MDS0796326	Sizes 3-4
MDS0796331	Sizes 5-6
MDS0796336	Sizes 7-8



## WILLIAMS LACRIMAL PROBES

Double-ended. Bulbous tip. Overall length 5½" (14cm).

<u>Item Number</u>	<u>Description</u>
MDS0796411	Size 00-0
MDS0796416	Sizes 1-2
MDS0796421	Size 3-4
MDS0796426	Size 5-6
MDS0796431	Size 7-8



## JAMESON CALIPER

Modified, with fine points, for accurate measurements of recessions.

<u>Item Number</u>	<u>Description</u>
MDS0793261	Overall length, fully closed, 3 <sup>7</sup> / <sub>8</sub> " (9.8cm)



## THORPE CALIPER

Used for measurements.

<u>Item Number</u>	<u>Description</u>
MDS0793266	Overall length, fully closed, 4 <sup>1</sup> / <sub>4</sub> " (10.8cm)



## CASTROVIEJO CALIPERS

Combination measuring and marking instrument.  
Thumbscrew to hold tips apart 0-20mm.  
Overall length 3<sup>1</sup>/<sub>4</sub>" (8.3cm).

<u>Item Number</u>	<u>Description</u>
--------------------	--------------------

MDS0793211	Straight
------------	----------

MDS0793216	Curved
------------	--------



## METRIC RULER

Deeply etched with accurate scales.

<u>Item Number</u>	<u>Description</u>
--------------------	--------------------

MDS0234015	Length 6" (15cm)
------------	------------------



## SCHOCKERT DOUBLE-END SCLERAL DEPRESSOR

One rounded end, one hammer end.  
Overall length 5<sup>1</sup>/<sub>2</sub>" (14.1cm).

<u>Item Number</u>	<u>Description</u>
--------------------	--------------------

MDS0717711	With pocket clip
------------	------------------



## FLYNN SCLERAL DEPRESSOR

5mm loop. Lens loop-style tip.

<u>Item Number</u>	<u>Description</u>
--------------------	--------------------

MDS0717716	Overall length 3 <sup>1</sup> / <sub>8</sub> " (8cm)
------------	--







PROFESSIONAL  
SURGICAL  
INSTRUMENTS



## Profile

We are engaged in production of following Products since last 2 Decades.

A description of our products is as following which we are producing and exporting to all over the world.

- Ø GENERAL SURGERY INSTRUMENTS
- Ø DENTAL INSTRUMENTS
- Ø HOSPITAL WARE PRODUCTS
- Ø TUNGSTEN CARBIDE INSTRUMENTS
- Ø MANICURE PEDICURE INSTRUMENTS

All the instruments are manufactured by dedicated team of professionals under the quality management system of ISO 9001:

We are also authorized to mark CE on our products.

Customer satisfaction is our prime objective.

A glance on our Track Record will firmly manifest the position of our company in recent scenario.

Certificates: - ISO-9001:2008 / 13485:2003 / CE-MARK / CGMP-USA

Manufacturing Capacity: - 500,000 - 800,000 Pcs/month

Employees: - 350

Annual Exports: - 4 MILLION US\$

Affiliation: -

The Chamber of Commerce and Industry Sialkot, Pakistan.

### Certification



### Catalogue Request

New 2014 Innovative Products







PROFESSIONAL  
SURGICAL  
INSTRUMENTS



2018-2019

# Surgical Catalogue

Pak Office:

Kashmir Road Sialkot 51310  
Cell No:+92-344-6331953  
+92-307-6137914  
Email:info@mgsurgico.com  
surgical\_co@yahoo.com  
www.mgsurgico.com



0092-344-6331953

We are always  
ready to help you!



www.mgsurgico.com